

DAAU – ~~FY20 Maintenance and Cross System Voting and Meteor Downs South Expansion Tariff~~FY22
Annual Review of Reference Tariffs

Aurizon Network Pty Ltd

The 2017 Undertaking

Contents

Part 1 : Preamble	10
1.1 Aurizon Network	10
1.2 Responsibilities	10
1.3 Access undertaking	10
1.4 Approval	10
1.5 Information	10
1.6 Negotiating Access	10
Part 2 : Intent and Scope	11
2.1 Duration	11
2.2 Objective	11
2.3 Behavioural obligations	12
2.4 Scope	14
2.5 Aurizon Holdings to execute Deed	15
2.6 Electricity supply and sale	15
Part 3 : Ringfencing	17
Section A – General Provisions	17
3.1 Application	17
3.2 Objectives	17
not engage in conduct	18
for the purpose of	18
3.3 Reporting and investigation obligations	18
Section B – Aurizon Network’s Independence	18
3.4 Below Rail Services	18
3.5 Staffing	20
3.6 Transfers and secondments	21
3.7 Performance of Below Rail Services	21
3.8 Accounting separation	22
Section C – Independent Governance	24
3.9 Independent Governance	24
Section D – Confidential Information	25

3.10	Overarching commitment to information security	25
3.11	Disclosure of Confidential Information	26
3.12	Grouping of Confidential Information	29
3.13	Responsibility	30
3.14	Confidential Information Register	30
3.15	Mandatory Confidential Information training	31
3.16	Confidentiality undertakings	32
3.17	Exit certificates	32
3.18	Security measures	32
3.19	Compliance declaration	33
3.20	Decision making	34
Section E – Complaints and Waiver		35
3.21	Complaint handling	35
Section F – Responsibility for Rail Infrastructure		36
3.22	Line Diagrams	36
Part 4 : Negotiation framework		39
4.1	Overview	39
4.2	Initial enquiries	40
4.3	Access Application	40
4.4	Acknowledgement of Access Application	42
4.5	Revisions to an Access Application	43
4.6	Indicative Access Proposal	48
4.7	Notification of intent	50
4.8	Access Applications that require Expansions	51
4.9	Multiple applications for the same Access	53
4.10	Requirements for Customers, Customer Access Seekers and Train Operators	54
	4.10.1 Customers and Customer Access Seekers	54
	4.10.2 Train Operators	56
4.11	Negotiation process	57
	4.11.1 Negotiation Period	57
	4.11.2 Issues to be addressed during negotiation	60
4.12	Negotiation of Access Agreements and Train Operations Deeds	63

4.13	Cessation of negotiations	65
Part 5 : Access Agreements		69
5.1	Development of Access Agreement	69
5.2	Access Charges under Access Agreements	70
5.3	Development of Train Operations Deed	71
5.4	Rebate under Access Agreements	72
Part 6 : Pricing principles		74
6.1	Application of pricing principles	74
6.2	Price differentiation	74
6.2.1	Limitations on price differentiation	74
6.2.2	Default application of Reference Tariff	75
6.2.3	Price differentiation where a Reference Tariff applies	75
6.2.4	Price differentiation where no Reference Tariff applies	76
6.2.5	Consequences if contravention of Part 6	76
6.3	Access Charges for new coal carrying Train Services	77
6.3.1	Determination of Access Charges	77
6.3.2	QCA approval of Private Incremental Costs	79
6.4	Access Charges for coal carrying Train Services that require an Expansion	81
6.4.1	Expansion pricing principles	81
6.4.2	Consensus Expansion	82
6.4.3	Other Expansions	83
6.4.4	Pricing Proposal	83
6.4.5	Calculation of indicative Reference Tariff for Endorsed Expansions	85
6.4.6	Reference Tariffs	87
6.4.7	Formalisation of Pricing Proposal	88
6.4.8	Allocation of Asset Replacement and Renewal Expenditure	88
6.4.9	Indicative Access Charge	88
6.4.10	Interaction with Access Charges for new or additional coal carrying Train Services that involve the use of Private Infrastructure	89
6.5	Process for acceptance of new Reference Tariff	89
6.5.1A	Application	89
6.5.1	Process	89
6.5.2	Access Charge review provisions	91
6.6	Pricing limits	91
6.6.1A	Application	91
6.6.1	Application of pricing limits	91
6.6.2	Setting price limits	92
6.6.3	Application of Maximum Allowable Revenue	92
6.7	Pricing objectives	94
6.7.1	Rail Infrastructure utilisation	94

6.8	Revenue adequacy	95
6.9	Reference Tariffs	95
	6.9.1 Application of Reference Tariffs	95
	6.9.2 Review of Reference Tariffs	96
	6.9.3 Publishing updated Schedule F	96
6.10	Structure of non–Reference Tariff Access Charges	96
6.11	QCA Levy	97
6.12	Regulatory Asset Base	97
6.13	Access Conditions	97
	6.13.1 Negotiation of Access Conditions	97
	6.13.2 Approval of Access Conditions	97
	6.13.3 Prohibited Access Conditions	100
Part 6A Extension of Schedule F values		102
6A.1	Overview	102
6A.2	Calculation and submission of Reset Schedule F Preliminary Values	102
6A.3	Development of Allowable Revenue component of the Reset Schedule F Preliminary Values	103
6A.4	Development of ‘Reference Tariff input’ component of Reset Schedule F Preliminary Values	104
6A.5	Calculation and submission of Reset Schedule F Values	104
6A.6	Supporting documentation and change in rates or indices	105
6A.7	Approval of Reset Schedule F Values	105
Part 7 : Available Capacity allocation and management		108
7.1	Application	108
7.2	Capacity allocation and registers	109
	7.2.1 General requirement for allocation	109
	7.2.2 Capacity Notification Register	110
	7.2.3 Committed Capacity Register	111
7.3	Renewals	112
7.4	Dealing with Access Rights	115
	7.4.1 Transfers	115
	7.4.2 Transfer Notice	116
	7.4.3 Criteria for a Transfer to take effect	118
	7.4.4 Effect of Short Term Transfers	119
	7.4.5 Effect of Long Term Transfers	120
	7.4.6 Transfer Fee and Adjustment Charges	121
	7.4.7 Customer Initiated Transfers	123
	7.4.8 Relinquishments	125

7.4.9	General provisions	128
7.5	Mutually Exclusive Access Applications	131
7.5.1	Notification and assistance	131
7.5.2	Queuing mechanism	131
7.5.3	Mutually Exclusive Access Application	134
7.6	Capacity resumption	135
Part 7A : Capacity		139
7A.1	Intent	139
7A.2	Definition of Deliverable Network Capacity and System Capacity	139
7A.3	Engagement of Independent Expert	141
7A.3.1	Appointment of Independent Expert	141
7A.3.2	[Not used]	142
7A.3.3	Termination of engagement of Independent Expert	142
7A.3.4	Costs	144
7A.3.5	Appointment of initial Independent Expert	144
7A.4	Capacity Assessments by Independent Expert	144
7A.4.1	IE Initial Capacity Assessment	144
7A.4.2	Annual Capacity Assessment	149
7A.4.3	System Capacity Assessments	150
7A.4.4	Capacity Assessments to be final and binding	152
7A.5	Existing Capacity Deficit	153
7A.6	Rebate	158
7A.7	Network Management Principles	162
7A.7.1	Compliance with Network Management Principles	162
7A.7.2	Nature of the System Rules	163
7A.7.3	Making the initial System Rules for a Coal System	163
7A.7.4	Reviewing and amending the System Rules	164
7A.7.5	Approval of System Rules	166
7A.7.6	General provisions	168
7A.8	Supply Chain coordination	169
7A.8.1	Proposal for Supply Chain Coordination Entity	169
7A.8.2	Aurizon Network's participation in Supply Chain Groups	171
7A.8.3	Aurizon Network's Supply Chain obligations	172
7A.9	System Operating Parameters	173
7A.10	Network Development Plan	176
7A.11	Maintenance Work	178
7A.11.1	Maintenance Objectives	178
7A.11.2	Composition of Rail Industry Group	179
7A.11.3	Approval of draft Maintenance Strategy and Budget and draft Renewals Strategy and Budget for a Coal System for a Year	180

7A.11.4	Submission of proposed Maintenance Indicator and Capital Indicator for annual review of Reference Tariffs	186
7A.11.5	QCA approval of actual maintenance costs	187
7A.11.6	QCA approval of actual Asset Replacement and Renewal Expenditure	189
7A.11.7	Asset Replacement and Renewal Expenditure	190
7A.11.8	End User Voting Rights (Network) and End User Voting Rights (Coal System)	191
7A.12	Amendment to Access Agreements	191
7A.13	Non-coal carrying Train Services	192
7A.13.1	Utilisation of Rail Infrastructure for non-coal carrying Train Services	192

Part 8 : Network development and Expansions **193**

8.1	Overview	193
8.2	General principles	193
8.2.1	Rights and obligations to fund, construct or permit the creation of new Rail Infrastructure	193
8.2.2	Disputes under Part 8	199
8.2.3	Interdependent and sequential nature of Expansions	201
8.2.4	Determination of sufficient demand for an Expansion	203
8.2.5	Participation of Customers	204
8.2.6	Compliance with obligations	205
8.3	Undertaking Concept Studies, Pre-feasibility Studies and Feasibility Studies	205
8.3.1A	Application	205
8.3.1	Concept Studies	206
8.3.2	Pre-feasibility Study	206
8.3.3	Feasibility Studies	207
8.3.4	General provisions	208
8.4	Funding Concept Studies, Pre-feasibility Studies and Feasibility Studies	210
8.4.1A	Application	210
8.4.1	Concept Studies	210
8.4.2	Pre-feasibility Studies	210
8.4.3	Feasibility Studies	212
8.4.4	General provisions	215
8.5	Provisional Capacity Allocation	217
8.6	Step-in where Aurizon Network fails to enter into Studies Funding Agreement or delay doing so	220
8.7	Funding an Expansion	223
8.7.1A	Application	223
8.7.1	General	223
8.7.2	Inclusion of Expansion cost in Regulatory Asset Base	226
8.8	User Funded Expansions	227
8.8.1	Process where Users intend to fund an Expansion	227

8.8.2	Inconsistency with a User Funding Agreement	228
8.9	Contracting for Capacity	228
8.9.1	Access Agreements conditional on an Expansion	228
8.9.2	Capacity analysis	229
8.9.3	Capacity shortfall	230
8.9.4	Expansion Capacity Deficit	231
8.9.5	Reduction of Conditional Access Rights	233
Part 9 : Connecting Private Infrastructure		236
9.1	Connecting Infrastructure	236
9.2	Development of Standard Rail Connection Agreement	240
Part 10 : Reporting, compliance and audits		243
10.1	Overview	243
10.2	General Principles	243
10.3	Not Used	243
10.4	Reports	243
10.4.1	Annual financial report	243
10.4.2	Public annual Regulatory Asset Base roll-forward report	244
10.4.3	Conditions Based Assessment	244
10.5	Compliance with this Undertaking	247
10.5.1	Compliance Officer	247
10.5.2	Annual compliance report	247
10.5.3	Breach reports to the QCA	250
10.6	Audit	251
10.6.1	Report auditing	251
10.6.2	Ringfencing audit	252
10.6.3	Independent compliance audit	252
10.6.4	Audit process	253
10.7	General	257
10.7.1	Information provision	257
10.7.2	Errors in reports	258
10.7.3	Certifications required from Aurizon Network's Executive Officer	258
10.8	Provision of additional network performance information	259
10.8.1	Intent	259
10.8.2	Aurizon Network to provide performance information to Independent Expert	259
10.8.3	Independent Expert to provide monthly network performance report	263
10.8.4	Independent Expert to provide additional monthly performance report to each Access Holder and Customer	266
10.8.5	Independent Expert can request Aurizon Network to prepare reports	266

Part 11 : Dispute Resolution and Decision Making	268
11.1 Dispute Resolution	268
11.1.1 Disputes	268
11.1.2 Chief executive resolution	269
11.1.3 Mediation	270
11.1.4 Expert determination	271
11.1.5 Determination by the QCA	275
11.1.6 Procedure	277
11.1.7 Application to Part 8 Disputes	277
11.2 QCA decision-making	277
Part 12 Definitions and Interpretation	280
12.1 Definitions	280
12.2 Interpretation	353
12.3 Notices	356
12.4 Transitional	357
12.5 New declaration	358
12.6 End User DAAU	359
Schedule A	361
Schedule B	365
Schedule C	372
Schedule D	383
Schedule E	388
Schedule F	410
Schedule G	<u>471472</u>
Schedule H	498
Schedule I	505
Schedule J	518
Schedule K	531

Part 1: Preamble

1.1 Aurizon Network

Aurizon Network is a member of the Aurizon Group which operates as a leading integrated national transport provider.

1.2 Responsibilities

Aurizon Network is responsible for providing, maintaining and managing the Rail Infrastructure and for providing and managing access to it.

1.3 Access undertaking

This Undertaking governs the process by which Access will be negotiated and provided.

1.4 Approval

This Undertaking has been approved by the QCA in accordance with the Act.

1.5 Information

Information on obtaining Access is contained in this Undertaking. Further information can be found on the Website.

1.6 Negotiating Access

To negotiate Access please email access.services@aurizon.com.au.

Part 2: Intent and Scope

2.1 Duration

- (a) This Undertaking is effective from the Approval Date to the Terminating Date.
- (b) Following the Approval Date, Adjustment Charges will be calculated in respect of the period between the Adjustment Date and the Approval Date in accordance with **Schedule F** and will be payable in accordance with that Schedule. For clarity, the Adjustment Charges do not involve the retrospective application of this Undertaking, but are amounts payable under this Undertaking that have been calculated by reference to a period prior to the Approval Date.

2.2 Objective

The objective of this Undertaking is, without limitation, to:

- (a) ensure the service taken to be declared under section 250(1)(a) of the Act is provided in a manner that does not unfairly differentiate in a material way (as that term is defined in section 137(3) of the Act);
- (b) prevent Aurizon Network recovering, through the price of access to the service taken to be declared under section 250(1)(a) of the Act, any costs that are not reasonably attributable to the provision of that service;
- (c) facilitate the negotiation of access agreements by Aurizon Network and Access Seekers;
- (d) apply the provisions of the Act through:
 - (i) the establishment of processes for Access negotiations and the utilisation of Capacity that are expeditious, efficient, timely, flexible, commercial and non-discriminatory;
 - (ii) the establishment of processes and principles to provide guidance in relation to the pricing, and the terms and conditions, of Access; and
 - (iii) the establishment of processes and principles for the planning and development of Expansions and the framework for the negotiation of terms for the funding of Pre-feasibility Studies, Feasibility Studies and Expansions;
- (e) provide an efficient, effective and binding Dispute resolution process; and
- (f) provide that actions under this Undertaking are consistent with the objectives for rail under section 2(2)(d) of the TIA and that such actions and this Undertaking are also consistent with the objectives and provisions of the Act.

2.3 Behavioural obligations

In providing Access and in negotiations for Access, Aurizon Network:

- (a) must act in a manner that is consistent with the unfair differentiation obligations under sections 100(2) to (4) and section 168C of the Act.
- (b) Without limiting **clause 2.3(a)**, the steps that Aurizon Network must take to comply with the general obligation in **clause 2.3(a)** are set out in this Undertaking and include the following:
 - (i) this Undertaking must be consistently applied to Access Seekers, Access Applications, negotiations for Access, Access Holders and Railway Operators;
 - (ii) Aurizon Network must not unfairly differentiate between Access Seekers, Access Holders or Railway Operators in a way that has a material adverse effect on the ability of any of them to compete with any other of them, including in relation to:
 - (A) any decision relating to whether Aurizon Network will undertake an Expansion;
 - (B) assessing, allocating and managing Capacity as provided for pursuant to this Undertaking;
 - (C) providing scheduling and Network Control Services in accordance with the Network Management Principles;
 - (D) any decision relating to the source of funding for an Expansion;
 - (E) assessing and selecting Access Seekers, and
 - (F) any decision relating to the provision of Access to:
 - (1) a Related Operator;
 - (2) a Related Competitor; or
 - (3) a Third Party that has commercial arrangements with a Related Operator or Related Competitor.
- (c) Aurizon Network must not engage in conduct for the purpose of preventing or hindering an Access Seeker's access to the declared service within the meaning of section 104 or 125 of the Act.
- (d) Without limiting **clause 2.2(a)**, Aurizon Network must ensure that:
 - (i) all transactions between Aurizon Network and any other party in relation to Access are conducted on an arms-length basis;
 - (ii) all Access Seekers, irrespective of whether they are an Aurizon Party or a Third Party:

- (A) are provided with a consistent level of service; and
 - (B) given an equal opportunity to obtain Access Rights, subject to the express provisions of the Act and this Undertaking; and
 - (iii) all decisions made under this Undertaking are made in a manner that does not unfairly differentiate in a material way (as that term is defined in section 137(3) of the Act) between any Access Seekers and/or Access Holders;
- (e) Aurizon Network must not engage in any activity or conduct (or agree to engage in such activity or conduct), either independently or with Related Operators, which has the purpose of, results in or creates, or is likely to result in or create:
- (i) anti-competitive cost shifting;
 - (ii) anti-competitive cross-subsidies; or
 - (iii) anti-competitive price or margin squeezing.
- (f) For clarity, none of **clauses 2.3(b)(ii), 2.3(c) or 2.3(d)(iii)** prevent Aurizon Network from engaging in conduct expressly permitted by section 100(3) of the Act (subject to section 100(4) of the Act) or section 168C of the Act (subject to section 168C(3) of the Act).
- (g) If an Access Seeker or Access Holder considers that Aurizon Network has failed to comply with **clause 2.3(a)** to (e), it may lodge a written complaint with Aurizon Network and must provide a copy of that complaint to the QCA.
- (h) Aurizon Network must:
- (i) advise the QCA, as soon as practicable, of any complaints it receives under **clause 2.3(g)**;
 - (ii) investigate complaints received under **clause 2.3(g)**; and
 - (iii) within twenty-eight (28) days after receiving such a complaint, advise the complainant and the QCA in writing of the outcome of that investigation and Aurizon Network's proposed response, if any.
- (i) If the complainant is not satisfied with the outcome of Aurizon Network's investigation, the complainant may apply to the QCA requesting an audit of the conduct that is the subject of the complaint under **clause 2.3(g)**.
- (j) If a complainant applies to the QCA in accordance with **clause 2.3(i)** the QCA may request Aurizon Network to:
- (i) engage an auditor in accordance with **clause 10.6.3**; and
 - (ii) conduct an audit in accordance with **clause 10.6.4**,

in respect of Aurizon Network's compliance with **clause 2.3(a) to (e)** as it relates to the relevant complaint.

- (k) For clarity, the rights and obligations under **clause 2.3(g)** to (j) do not replace or derogate in any way from, the QCA's powers under the Act. Nothing in this Undertaking precludes an Access Seeker or Access Holder making any complaint or submission to the QCA.

2.4 Scope

- (a) This Undertaking provides only for the negotiation and provision of Access and is not applicable to the negotiation or provision of services other than Access. For clarity, "Access" in this **clause 2.4** includes all aspects of access to the service taken to be declared under section 250(1)(a) of the Act.
- (b) Access Holders are responsible for:
 - (i) the provision of any services other than Access, including Above Rail Services, required for the operation of Train Services; and
 - (ii) the necessary approvals from the owners of the land upon which the Rail Infrastructure is situated if it is not owned by Aurizon Network and Aurizon Network does not have an existing legal right to authorise Access Holders to access that land.
- (c) Aurizon Network must promptly notify the Access Holder if Aurizon Network does not own the land upon which the Rail Infrastructure is situated or have an existing legal right to authorise the Access Holder or its Nominated Railway Operator to access that land.
- (d) Nothing in this Undertaking can require Aurizon Network to act in a way that is inconsistent with its Passenger Priority Obligations or Preserved Train Path Obligations.
- (e) Nothing in this Undertaking can require Aurizon Network or any other party to an Access Agreement, executed before the Approval Date, to
 - (i) subject to **clause 7A.12**, vary that Access Agreement; or
 - (ii) subject to **clauses 7A.5(f), 7A.5(g) and 7A.5(l)**, to act in a way that is inconsistent with the relevant Access Agreement.
- (f) Except where expressly stated in this Undertaking to the contrary, this Undertaking will not apply to the extent that it is inconsistent with an Access Agreement or a Train Operations Deed.
- (g) Nothing in this Undertaking affects the rights of Aurizon Network or other parties under the Act.

2.5 Aurizon Holdings to execute Deed

- (a) Aurizon Network must request that its Ultimate Holding Company provides the Ultimate Holding Company Support Deed (**Deed**) in the form set out in **Schedule D**.
- (b) If:
 - (i) Aurizon Network fails to obtain a Deed in the form required by **clause 2.5(a)**;
 - (ii) the Deed, if obtained, is not maintained in force; or
 - (iii) the requirements of the Deed are not complied with,then Aurizon Network must, from the Approval Date (in the case of **clause 2.5(b)(i)**) or the date of non-compliance (in the case of **clauses 2.5(b)(ii)** or **(iii)**):
 - (iv) every three (3) Months, conduct and complete an audit of the Confidential Information Register in accordance with **Part 10** to confirm the Confidential Information Register complies with the requirements of this Undertaking for the previous three (3) Months period; and
 - (v) every six (6) Months, conduct detailed training sessions in respect of Aurizon Network's statutory obligations under the Act and under **Part 3** (including regarding the management of Confidential Information) for all Key AN Commercial Personnel and Senior AN Employees,until either:
 - (vi) if **clause 2.5(b)(i)** or **(ii)** applies, Aurizon Network obtains a current Deed from the Ultimate Holding Company; or
 - (vii) if **clause 2.5(b)(iii)** applies, the failure to comply with the requirements of the Deed is rectified to the satisfaction of the QCA.

If a provision of **Part 3** is inconsistent with this provision, this provision prevails.

2.6 Electricity supply and sale

- (a) To the extent that Aurizon Network sells or supplies a Related Operator with electric energy in connection with Access, Aurizon Network cannot refuse to sell or supply electric energy to another Access Seeker or Access Holder (or, if applicable, a Nominated Railway Operator).
- (b) Despite any other provision of this Undertaking, Aurizon Network will not be obliged to sell or supply electric energy to an Access Seeker or Access Holder (or, if applicable, a Nominated Railway Operator) or to agree to do so:

- (i) if Aurizon Network is not lawfully entitled to sell or supply electric energy to the relevant Access Seeker, Access Holder or, if applicable, Nominated Railway Operator under any Law, including the *Electricity Act 1994* (Qld) and the National Electricity Rules (as defined under the National Electricity Law set out in the schedule to the *National Electricity (South Australia) Act 1996* (SA)); or
 - (ii) on terms that would be unreasonable or uncommercial.
- (c) For clarity, if a dispute arises between an Access Holder, a Nominated Railway Operator or an Access Seeker and Aurizon Network regarding a refusal by Aurizon Network to sell or supply electric energy (or procure such a sale or supply from an Aurizon Party), or the proposed terms and conditions on which Aurizon Network (or an Aurizon Party) offers to sell or supply electric energy to the Access Holder, Nominated Railway Operator or Access Seeker, any party may require the Dispute to be resolved in accordance with **clause 11.1**.

Part 3: Ringfencing

Section A – General Provisions

3.1 Application

- (a) Subject to **clause 3.1(b)**, Sections A to E (inclusive) of this **Part 3** will apply for as long as shares in Aurizon Network are directly or indirectly owned by Aurizon Holdings or any Related Party of Aurizon Holdings.
- (b) Notwithstanding **clause 3.1(a)**, if at any time during the Term neither Aurizon Holdings nor any Related Party of Aurizon Holdings directly or indirectly owns any shares in Aurizon Network, the following clauses will continue to apply:
 - (i) this **clause 3.1(b)**;
 - (ii) **clauses 3.10(a)** and **3.10(b)**;
 - (iii) **clause 3.11(a)(i)** to **3.11(a)(iii)** (inclusive);
 - (iv) **clause 3.11(b)**;
 - (v) **clause 3.11(c)** (other than **clause 3.11(c)(vii)** in so far as it relates to Aurizon Holdings and **clause 3.11(c)(xii)(C)**);
 - (vi) **clause 3.11(d)**; and
 - (vii) **clause 3.11(e)** (other than the proviso at the end of **clause 3.11(e)(i)**).

3.2 Objectives

- (a) The objectives of this **Part 3** are, subject to the express provisions of this **Part 3**, to:
 - (i) ensure that Access provided by Aurizon Network is managed and supplied independently from other members of the Aurizon Group who compete in upstream and downstream markets that depend on Access to the service utilising the Rail Infrastructure;
 - (ii) ensure that Confidential Information is not subject to unauthorised disclosure or use;
 - (iii) ensure independence of decision making in the governance of Aurizon Network;
 - (iv) restrict the movement of relevant staff within the Aurizon Group so as to help ensure compliance with the ringfencing obligations;
 - (v) provide a complaints process for the investigation of potential breaches of this **Part 3**; and

- (vi) guide Aurizon Network's compliance with its various obligations under the Act, namely:
 - (A) to negotiate in good faith with Access Seekers regarding the provision of Access under section 100(1) of the Act;
 - (B) to not unfairly differentiate between Access Seekers or between Access Holders in the ways referred to in sections 100 and 168C of the Act; and
 - (C) to not engage in conduct for the purpose of preventing or hindering an Access Holder's access to the service taken to be declared under section 250(1)(a) of the Act in accordance with sections 104 and 125 of the Act.
- (b) To the extent of any ambiguity in this **Part 3**, an interpretation of that provision which is consistent with the objectives in **clause 3.2(a)** must be preferred.

3.3 Reporting and investigation obligations

- (a) A breach of any of the obligations in this **Part 3** will be reported to the QCA in accordance with the obligations in **clause 10.5.3**, on the basis that it is reportable as soon as Aurizon Network becomes aware of the breach.
- (b) Aurizon Network will request that the Ultimate Holding Company will immediately notify Aurizon Network as soon as the Ultimate Holding Company becomes aware of a breach of the Ultimate Holding Company Support Deed.
- (c) Where Aurizon Network suspects that a breach of any obligation in this **Part 3** has occurred, the Compliance Officer will immediately investigate the suspected breach and, if the breach is confirmed, report that breach as required by **clause 10.5.3**.

Section B – Aurizon Network's Independence

3.4 Below Rail Services

- (a) Aurizon Network must not undertake, operate, provide or market, or engage in any activities required to undertake, operate, provide or market, any Above Rail Services in respect of the Rail Infrastructure (other than for the purpose of providing either services in respect of Private Infrastructure or Below Rail Services).
- (b) If Aurizon Network:

- (i) holds any direct or indirect interest in, or operates or manages any coal export terminal, port, loading facility, coal exploration project, coal mine or coal-extraction project connected or proposed to be connected (whether directly or indirectly) to the Rail Infrastructure; or
- (ii) provides any coal unloading, coal export, port, coal loading, coal exploration, coal mining or coal extraction services in connection with the operation of any Train Services,

in whatever capacity and whether alone or with others, then Aurizon Network must not use that position to engage in any conduct that has the purpose of unfairly differentiating in a material way (as that term is defined in section 137(3) of the Act) between Access Seekers or between Access Holders.

- (c) For clarity, and subject to the provisions of this Undertaking, the supply of Below Rail Services includes:
 - (i) the supply of the declared services contemplated by section 250(1)(a) of the Act;
 - (ii) negotiating Access Agreements with Access Seekers and managing Access Agreements with Access Holders;
 - (iii) negotiating and managing Train Operations Deeds with Train Operators;
 - (iv) receiving, assessing and responding to Access Applications;
 - (v) providing or procuring appropriate levels of maintenance for, and renewal of, the Rail Infrastructure to ensure that the Rail Infrastructure is provided to the standard required to meet Aurizon Network's obligations to Access Holders and, where applicable, Train Operators, the DTMR, and its infrastructure lessors;
 - (vi) assessing, allocating and managing Capacity;
 - (vii) providing scheduling and Network Control Services for Rail Infrastructure in accordance with the Network Management Principles;
 - (viii) providing use of electric transmission infrastructure on electrified sections of the Rail Infrastructure to enable Access Holders or Train Operators to run electric Train Services and (subject to **clause 2.6**) selling or supplying electric energy for traction on electrified sections of the Track, including managing electric energy supply from other parties, where an Access Seeker, an Access Holder or Train Operator requests Aurizon Network to provide that electric energy; and
 - (ix) the administration of the process for network development, planning, studies and Expansions in accordance with **Part 8**.

3.5 Staffing

- (a) Subject to the reporting allowed under **clauses 3.9(a)(ii) to 3.9(a)(v)**, Aurizon Network must not permit employees of Aurizon Network:
 - (i) whose duties primarily involve the provision of Below Rail Services, to perform work for any Aurizon Entity other than Aurizon Network; or
 - (ii) undertake any work at the direction of a Related Operator.
- (b) Nothing in **clause 3.5(a)**, and subject always to Section D (Confidential Information) of this **Part 3**, restricts or prevents an employee of Aurizon Network:
 - (i) performing functions that are required to negotiate for, or provide Access to, a Related Operator in accordance with the terms of this Undertaking or the Act;
 - (ii) undertaking any function or activity:
 - (A) required or compelled by any Law;
 - (B) required or compelled by any order of a court;
 - (C) required or compelled by notice validly issued by any Authority;
 - (D) necessary for the conduct of any legal proceedings, dispute resolution process or audit under this Undertaking, the Act or a Standard Agreement; or
 - (E) in the course of responding to an emergency or natural disaster or for clearing an incident or emergency that is preventing or impeding the operation of Train Services on the Rail Infrastructure; or
 - (iii) engaging in:
 - (A) asset construction, maintenance, renewal or repair; or
 - (B) support services and/or corporate functions, for any Aurizon Group business unit or corporate functional area.
- (c) Subject to compliance with Aurizon Network's obligations under this **Part 3**, Aurizon Network may obtain assistance in the performance by Aurizon Network of Below Rail Services and to comply with its obligations in this Undertaking from staff employed within the Aurizon Group (other than a Related Operator) in the provision of shared services and corporate functions to different functional areas and parts of the Aurizon Group.

3.6 Transfers and secondments

- (a) Subject to the other provisions of this **clause 3.6**, Aurizon Network agrees not to:
- (i) Transfer or seek to Transfer a Senior AN Employee or Key AN Commercial Personnel to work in a Related Operator or a Related Competitor in any capacity; or
 - (ii) Transfer or seek to have Transferred a Senior Related Operator Employee or Senior Related Competitor Employee to work in the Aurizon Network business in any capacity.
- (b) If Aurizon Network:
- (i) seeks to Transfer a Senior AN Employee or Key AN Commercial Personnel; or
 - (ii) wishes to accept a Senior Related Operator Employee or Senior Related Competitor Employee transferee,
- where such a Transfer would otherwise be prohibited by **clause 3.6(a)**, it must seek the prior approval in writing from a Majority of End Users. Such approval must not be unreasonably withheld or delayed.
- (c) Where in respect of a Transfer that is to be effected in a Year:
- (i) approval for a proposed Transfer required under **clause 3.6(b)** is provided by a Majority of End Users; or
 - (ii) End Users either:
 - (A) unreasonably withhold approval of the Transfer; or
 - (B) delay voting on the approval of such Transfer for more than 20 Business Days after Aurizon Network seeks approval of the Transfer from the End Users,the proposed Transfer can proceed.
- (d) A Transfer of employees between Aurizon Network and a Related Operator or a Related Competitor, whether under this **clause 3.6** or otherwise is always subject to Section D (Confidential Information) of this **Part 3**.

3.7 Performance of Below Rail Services

- (a) The Below Rail Services must not be transferred or delegated to, contracted out to, or otherwise undertaken, by a Related Operator except as allowed under **clause 3.7(b)(i)**.
- (b) Subject to **clause 3.7(c)** and Section D (Confidential Information) of this **Part 3**, nothing in this Undertaking prevents Aurizon Network from:

- (i) obtaining Field Incident Management and Yard Control services at yards other than Major Yards from a Related Operator; or
- (ii) engaging a Related Party of Aurizon Network (other than a Related Operator or a Related Competitor) to undertake:
 - (A) maintenance for or renewal of the Rail Infrastructure;
 - (B) project delivery, engineering or rail construction services in relation to the procurement, construction or design of Rail Infrastructure;
 - (C) the safe operation of the Rail Infrastructure (including any incident investigations);
 - (D) environmental related services (including any incident investigations); or
 - (E) normal corporate governance arrangements and management reporting, including assessing the credit risk of counterparties or otherwise assessing the implications of an arrangement on Aurizon Network's access to funds or the taxation consequences of that arrangement.
- (c) For clarity, notwithstanding the transfer, delegation or contracting out of Below Rail Services by Aurizon Network to a Related Operator under **clause 3.7(b)(i)**, Aurizon Network remains responsible for providing Below Rail Services in accordance with this Undertaking.

3.8 Accounting separation

- (a) Unless otherwise approved by the QCA, Aurizon Network must develop, on an annual basis:
 - (i) general purpose financial statements for Aurizon Network in accordance with relevant legislation and applicable Australian accounting standards; and
 - (ii) a supplementary set of financial statements which:
 - (A) separately identifies Aurizon Network's business in respect of the supply of the declared services contemplated by section 250(1)(a) of the Act from other business conducted by Aurizon Group;
 - (B) identifies costs common to both Aurizon Network and Aurizon Group and the way in which such costs are allocated; and
 - (C) are otherwise developed in accordance with the methodology and format set out in the Costing Manual.

- (b) The QCA may request Aurizon Network to prepare (or Aurizon Network may prepare) a Costing Manual. The processes set out in section 159 of the Act apply to that Costing Manual.
- (c) The financial statements must:
 - (i) include the information referred to in **clause 3.8(d)**;
 - (ii) be certified by Aurizon Network's Executive Officer as being in accordance with this Undertaking; and
 - (iii) be audited in accordance with **clause 10.6.4**.
- (d) The financial statements referred to in **clause 3.8(a)** must include details of Self-Insurance.
- (e) An audit of the financial statements referred to in **clause 3.8(a)** will be conducted:
 - (i) within six (6) Months of the end of the Year to which the financial statements relate, or such longer time as agreed by the QCA; and
 - (ii) subject to this **clause 3.8**, in accordance with **clause 10.6.4**.
- (f) Aurizon Network acknowledges that, in order to facilitate finalisation of the audit within the required timeframe, certain aspects of the audit may be undertaken by the Auditor at different times throughout the relevant Year.
- (g) The Auditor will:
 - (i) examine whether the financial statements referred to in **clause 3.8(a)** have been developed in all material respects in accordance with this Undertaking and consistent with the format specified in the Costing Manual; and
 - (ii) prepare an audit report that specifies:
 - (A) the scope of the audit;
 - (B) the level of access that the Auditor was provided to Aurizon Network's financial information, including the relevant information systems;
 - (C) whether or not the financial statements have been developed in all material respects in accordance with this Undertaking and consistent with the format specified in the Costing Manual; and
 - (D) information regarding any relevant non-compliance or inconsistency.

Section C – Independent Governance

3.9 Independent Governance

- (a) Aurizon Network must be governed and managed independently from other Aurizon Entities provided however that:
 - (i) Aurizon Holdings may appoint the directors of Aurizon Network;
 - (ii) Aurizon Network's Executive Officer may report to the Chief Executive Officer of the Aurizon Group;
 - (iii) the Chief Financial Officer of Aurizon Network may report to the Chief Financial Officer of the Aurizon Group;
 - (iv) the Associate General Counsel of Aurizon Network may report to the General Counsel of the Aurizon Group;
 - (v) Aurizon Network may report to the board of Aurizon Holdings as required for the purposes of good corporate governance practices and as required or compelled by any Law; and
 - (vi) subject to **clause 3.9(d)(ii)**, Aurizon Holdings may provide directions and guidance on the setting of strategy for Aurizon Network in the course of good corporate governance.
- (b) Without limiting **clause 3.9(a)**, Aurizon Network must take whatever steps it can reasonably take to ensure that Related Operators and Related Competitors do not directly or indirectly participate in the process for the appointment or supervision of the executive management of Aurizon Network.
- (c) Subject to the exceptions specified in **clause 3.9(a)**, Aurizon Network must take whatever steps it can reasonably take to ensure that each Senior AN Employee:
 - (i) has an independent reporting line that does not include a person that has direct or indirect responsibility for a Related Operator or a Related Competitor; and
 - (ii) does not have direct or indirect responsibility for a person employed or engaged by a Related Operator or a Related Competitor.
- (d) Aurizon Network must:
 - (i) ensure that Aurizon Network does not have any direct or indirect management responsibility for or to a Related Operator or a Related Competitor; and
 - (ii) not act on directions from any other Aurizon Entity in respect of the grant or exercise of Access Rights or Network Control Services, provided that this **clause 3.9(d)(ii)** does not prevent:

- (A) a Related Operator exercising a right or requiring Aurizon Network to comply with an obligation under an Access Agreement between Aurizon Network and that Related Operator; or
 - (B) Aurizon Network complying with an obligation under this Undertaking or the Act, as applicable.
- (e) Subject to **clause 3.9(f)**, Aurizon Network agrees to engage (at its cost) an independent observer to attend board meetings of Aurizon Network solely for the purpose of allowing that independent observer to confirm in writing to Aurizon Network every six (6) months (which Aurizon Network will then promptly publish on its Website) that Aurizon Network has:
 - (i) acted consistently with its obligations under this **clause 3.9**; and
 - (ii) employs good corporate governance practices consistent with good corporate governance practices for a company similar to Aurizon Network.
- (f) The independent observer referred to in **clause 3.9(e)**:
 - (i) must be engaged on terms which require the independent observer to maintain confidentiality in respect of all matters considered or listed for consideration at board meetings of Aurizon Network (other than for the purposes of the report referred to in **clause 3.9(e)**); and
 - (ii) must be a partner or senior manager employed by a national or international accounting firm nominated by the Chair of the Rail Industry Group on behalf of a Majority of End Users but not from an accounting firm appointed to undertake a financial audit of the Aurizon Group.

Section D – Confidential Information

Section D1 – General provisions

3.10 Overarching commitment to information security

Notwithstanding any other provision in this Undertaking, Aurizon Network must:

- (a) except as otherwise permitted by this Undertaking, keep Confidential Information confidential and secure;
- (b) not disclose Confidential Information, unless in accordance with this Undertaking; and
- (c) use or disclose Confidential Information only in connection with the supply of Below Rail Services, as permitted in accordance with this Undertaking but only to the extent necessary for that purpose.

Section D2 - Control framework for Confidential Information

3.11 Disclosure of Confidential Information

- (a) Subject to any other provision in this Section D2, Aurizon Network must not disclose Confidential Information unless:
- (i) the disclosure is permitted under this Undertaking;
 - (ii) access to or disclosure of that Confidential Information is limited so that disclosure to the Recipient is only to the extent necessary;
 - (iii) the Recipient is advised that the information is Confidential Information and the information is clearly identified as Confidential Information;
 - (iv) prior to access being granted or disclosure being made, all information relevant to that access or disclosure is recorded in the Confidential Information Register;
 - (v) if required under any provision in this Section D2, the Recipient has signed a declaration confirming its awareness and understanding of the Aurizon Network's obligations regarding Confidential Information;
 - (vi) if required under any provision in this Section D2 and if the Recipient is not within Aurizon Network, Aurizon Network enters into a legally enforceable agreement with the Recipient (with the same effect as the confidentiality agreement in the form set out in **Schedule I**) and on terms that are enforceable by the owner of the Confidential Information and Aurizon Network, requiring the Recipient (and any of its employees) to keep the Confidential Information confidential, and to only use it for the purpose for which it was disclosed.
- (b) Without limiting **clause 3.11(a)**, Aurizon Network may also disclose Confidential Information with the prior written consent of the owner of the Confidential Information to the Recipient for a nominated purpose.
- (c) Without limiting **clauses 3.11(a)(ii)** and **3.11(a)(iii)**, Aurizon Network may disclose Confidential Information to a Recipient when the disclosure is:
- (i) required or compelled by any Law;
 - (ii) required or compelled by any order of a court;
 - (iii) required or compelled by notice validly issued by any Authority;
 - (iv) necessary for the conduct of any legal proceedings;
 - (v) necessary for the conduct of a dispute resolution process;
 - (vi) necessary for an audit process;

- (vii) subject to **clause 3.11(d)**, required under any stock exchange listing requirement or rule (including disclosure to Aurizon Holdings so as to allow compliance with any such listing requirement or rule);
- (viii) for the purpose of facilitating Network Control directions where the disclosure of information is by Aurizon Network in the usual course of undertaking Network Control Services;
- (ix) necessary for the effective response to an emergency or natural disaster;
- (x) to the Safety Regulator;
- (xi) to Aurizon Network Personnel:
 - (A) whose duties in relation to Aurizon Network require the disclosure but only to the extent necessary for the performance of such duties; and
 - (B) who have been advised of the confidential nature of the Confidential Information;
- (xii) to an external legal, accounting or financial adviser or consultant (**Advisor**) or a banker, financier or other financial institution (**Financier**) to the extent that:
 - (A) the Advisor's or Financier's role in advising or providing services to Aurizon Network requires the disclosure to be made;
 - (B) the Advisor or Financier is under an obligation of confidentiality to Aurizon Network; and
 - (C) the Advisor or Financier has been advised of the Aurizon Group's and the Aurizon Network's Related Parties' obligations under this Undertaking regarding Confidential Information,

and provided that the Advisor or Financier is not also advising or otherwise working for any other Aurizon Entity in relation to the matter in respect of which Aurizon Network is seeking the advice or services from that Advisor or Financier and provided that the Advisor or Financier has undertaken in a legally binding way (with the same effect as the confidentiality agreement in the form set out in **Schedule I**) to keep the Confidential Information disclosed to it by Aurizon Network confidential.
- (d) Before any disclosure to satisfy a stock exchange listing requirement or rule under **clause 3.11(c)(vii)**, Aurizon Network must:
 - (i) consult with the owner of the Confidential Information as to the nature and extent of the disclosure of the Confidential Information; and

- (ii) to the extent reasonably possible, comply with any requests made by the owner of the Confidential Information (acting reasonably) to limit the disclosure of the Confidential Information.
 - (e) Nothing in **clause 3.11(c)** prevents Aurizon Network from disclosing Confidential Information to:
 - (i) a Railway Manager, but only to the extent required for the purpose of negotiating or providing Access or for managing interfaces between the railways (including scheduling and other interface issues), provided that the Railway Manager has undertaken in a legally binding way (with the same effect as the confidentiality agreement in the form set out in **Schedule I**) to keep the Confidential Information disclosed to it by Aurizon Network confidential; or
 - (ii) subject to **clause 3.11(e)(iii)**, a coal export terminal operator for a coal export terminal forming part of the Supply Chain for the purpose of allocating capacity at the coal export terminal, provided that the coal export terminal operator has undertaken in a legally binding way (with the same effect as the confidentiality agreement in the form set out in **Schedule I**) to keep the Confidential Information disclosed to it by Aurizon Network confidential;
- provided that Aurizon Network will:
- (iii) as soon as reasonably practicable after it becomes aware of a breach of a confidentiality undertaking referred to in this **clause 3.11(e)**, notify the owner of the information; and
 - (iv) use its best endeavours to enforce the confidentiality undertakings referred to in this **clause 3.11(e)** against the relevant third party if requested to do so by the owner of the information.
- (f) Disclosure of Confidential Information is permitted by Aurizon Network where the disclosure is to:
 - (i) directors of the Aurizon Holdings board;
 - (ii) directors of the Aurizon Network board;
 - (iii) the Chief Executive Officer of the Aurizon Group;
 - (iv) the Chief Financial Officer of the Aurizon Group;
 - (v) the Company Secretary of Aurizon Network or the Company Secretary of Aurizon Holdings;
 - (vi) the assistant Company Secretary of Aurizon Network or the assistant Company Secretary of Aurizon Holdings;
 - (vii) the General Counsel of the Aurizon Group;

- (viii) the Chief Internal Auditor of the Aurizon Group;
- (ix) the Chief Information Officer of the Aurizon Group;
- (x) an employee of any other Aurizon Entity for the purpose of undertaking work or services for Aurizon Network permitted by this Undertaking; and
- (xi) any person providing clerical or administrative assistance to the individuals or business units identified in **clauses 3.11(f)(i) to (ix)**,

provided that the relevant person(s):

- (xii) is (are) notified that the relevant information is Confidential Information, is confidential in nature and must be kept confidential; and
 - (xiii) (except those referred to in **clauses 3.11(f)(x) and 3.11(f)(xi)**), have undertaken in a legally binding way (with the same effect as the confidentiality agreement in the form set out in **Schedule I**) to keep the Confidential Information disclosed to it by Aurizon Network confidential; and
 - (xiv) (except those referred to in **clauses 3.11(f)(x) and 3.11(f)(xi)**), have undertaken the training contemplated by **clause 3.15**.
- (g) Aurizon Network must not disclose or seek to disclose any Confidential Information to a Related Operator other than as expressly permitted under this **clause 3.11** or with the prior written consent of the QCA.

3.12 Grouping of Confidential Information

- (a) If for the purposes of this Section D:
- (i) the Confidential Information can reasonably be grouped together in a single category because the Confidential Information relates to the same or substantially similar subject matter; or
 - (ii) there is a need for multiple instances of access to or disclosure of Confidential Information, and those instances can reasonably be grouped together in a single category because they relate to the same or similar subject matter or to a recipient whose role requires repeated access to Confidential Information,
- then, that Confidential Information is deemed to be one item of Confidential Information for the purpose of **clause 3.11** and **3.14**.
- (b) For the purpose of disclosing Confidential Information under **clause 3.11** or recording information in the Confidential Information Register under **clause 3.14**:

- (i) if disclosure of Confidential Information is to an entity, then the name of the entity (and not any of its directors or employees) needs to be recorded in the Confidential Information Register as the Recipient; or
- (ii) if the disclosure of the Confidential Information is only to an individual or individuals, then only the name of each individual needs to be recorded in the Confidential Information Register as the Recipient.

3.13 Responsibility

Aurizon Network acknowledges and agrees that despite any permitted disclosure of Confidential Information by Aurizon Network to any person within the Aurizon Group, Aurizon Network will be liable for any subsequent unauthorised use or disclosure by any such person within the Aurizon Group as if that use or disclosure had been made by Aurizon Network in breach of **Part 3** of this Undertaking.

Section D3 – Compliance monitoring and safeguards

3.14 Confidential Information Register

- (a) Aurizon Network must establish and maintain a Confidential Information Register.
- (b) Aurizon Network must, in consultation with the members of the Rail Industry Group (as notified by the Chair of the Rail Industry Group from time to time) consider any amendments necessary to the current Confidential Information Register and, within four (4) Months after the Approval Date, provide the QCA with its proposed amendments, (including as to structure and level of detail of information), to the Confidential Information Register.
- (c) Any amendments proposed by Aurizon Network must be approved by the QCA having regard to whether the Confidential Information Register is sufficiently detailed and sufficiently transparent.
- (d) The format (including content) of the Confidential Information Register may be varied, as required by the QCA.
- (e) The Confidential Information Register will contain, as a minimum:
 - (i) the identity of persons or entities who have access to Confidential Information;
 - (ii) in respect of each Recipient:
 - (A) the identity of the Recipient who has been approved in accordance with **clause 3.11** to have access to the Confidential Information, and the identity of the Aurizon Network Personnel who approved that access;

- (B) a review date at which access to that Confidential Information expires;
 - (C) the defined category of Confidential Information to which the Recipient has access (with sufficient details to enable the Confidential Information to be accurately identified); and
 - (D) the purpose for which the Confidential Information is to be used by the Recipient;
- (iii) a record of the signing of an exit certificate by Aurizon Network Personnel working within Aurizon Network and with access to Confidential Information at the time that the Aurizon Network Personnel leaves the employment of, or engagement with, Aurizon Network (whether to another business unit within the Aurizon Group on a temporary or permanent basis or a Third Party); and
 - (iv) details of any compliance issues in relation to Confidential Information where an investigation revealed a breach of Aurizon Network's obligations under this Undertaking.
- (f) An Access Seeker, Access Holder or Train Operator may, upon request, view information in the Confidential Information Register which relates to Confidential Information that it has disclosed to Aurizon Network.
 - (g) Aurizon Network must provide the QCA with access to the Confidential Information Register:
 - (i) each twelve (12) Months on and from the Approval Date; and
 - (ii) upon the QCA's request,
 to view the Confidential Information Register.
 - (h) The QCA may require the Confidential Information Register to be subject to an audit covering the following matters:
 - (i) in accordance with **Part 10** to confirm the Confidential Information Register complies with the requirements of this Undertaking; and
 - (ii) to confirm the processes and procedures underpinning the collection of information for the Confidential Information Register is fit for purpose, being complied with and is used in a consistent manner.

3.15 Mandatory Confidential Information training

- (a) Aurizon Network must ensure that all Aurizon Network Personnel and all employees of other Aurizon Entities receiving, or having access to, Confidential Information are made fully aware of the obligations of the

Aurizon Entities relating to Confidential Information, and complete training for this purpose.

- (b) Aurizon Network must ensure that the Compliance Officer establishes and maintains a record of training attendances (as a yearly percentage of the employees of the Aurizon Group and Aurizon Network Personnel) for publication in the annual compliance report prepared under **Part 10**.

3.16 Confidentiality undertakings

Aurizon Network must at all times ensure that each:

- (a) director of Aurizon Network;
- (b) Senior AN Employee; and
- (c) Key AN Commercial Personnel,

has executed an undertaking given in favour of Aurizon Network that they will comply with the requirements for confidentiality and other applicable requirements set out in Section D (Confidential Information) of this **Part 3**.

3.17 Exit certificates

- (a) Where an Aurizon Network Personnel that has had access to Confidential Information leaves Aurizon Network, Aurizon Network must ensure that:
 - (i) the Aurizon Network Personnel undergoes a debriefing session provided by Aurizon Network to remind the employee (or other person) of Aurizon Network's and its own obligations relating to the management of Confidential Information; and
 - (ii) it obtains an exit certificate (that includes an acknowledgement of having undergone such a debriefing process and that that person has returned or destroyed all Confidential Information in their possession) signed by that person.
- (b) The Confidential Information Register must include a record of signed exit certificates and persons who are requested to but do not sign an exit certificate.

3.18 Security measures

- (a) Aurizon Network must ensure that adequate security measures (physical, electronic and otherwise) are in place (including information barriers) to ensure that:
 - (i) only persons permitted by this Undertaking have access to Confidential Information in Aurizon Network's possession or control (whether in electronic or tangible form); and

- (ii) the access is only to the extent permitted for that person by this Undertaking.
- (b) Aurizon Network must ensure that all Aurizon Network Personnel are clearly identified as Aurizon Network Personnel in their dealings with Third Parties.
- (c) Aurizon Network must use all reasonable endeavours to ensure that its premises have in place adequate security measures to ensure that persons who are not Aurizon Network Personnel are unable to access the Aurizon Network offices where Confidential Information is located or stored, unless:
 - (i) access to those Aurizon Network offices is authorised by an Aurizon Network employee whose level of authority includes the right to authorise access to Aurizon Network's premises; and
 - (ii) the person is accompanied by an Aurizon Network employee at all reasonable times while in those premises.
- (d) Aurizon Network must use all reasonable endeavours to maintain a record, including reasonable details, of all persons (other than Aurizon Network Personnel) who have accessed each premise where Confidential Information is located or stored.
- (e) **Clause 3.18(c)** does not require that Aurizon Network be located in a different building to a Related Operator.

3.19 Compliance declaration

- (a) As part of the compliance report required under **clause 10.5.2**, Aurizon Network must, give the QCA a compliance declaration which must either:
 - (i) include a statement with the following effect: "There have been no breaches of the ringfencing arrangements set out in **Part 3** of the Undertaking and none of the matters set out in **clause 2.5(b)(i) to 2.5(b)(iii)** have occurred during the twelve (12) Month period commencing from the date of the last declaration given under **clause 3.19(a)** of the Undertaking (if any) ending up until the day prior to the date of this declaration"; or
 - (ii) if there have been any breaches of this **Part 3** or any of the matters set out in **clause 2.5(b)(i) to 2.5(b)(iii)** have occurred during the period for the compliance declaration, provide the following details in relation to each breach or matter:
 - (A) the nature, extent and circumstances of the breach or matter;

- (B) whether the breach or matter is under investigation or has been resolved; and
 - (C) any remedial actions taken or being considered in relation to the breach or matter.
- (b) The compliance declaration given under **clause 3.19(a)** must be signed by Aurizon Network's Executive Officer and the other member of the senior management team at Aurizon Network (**Other Officer**) who is most directly responsible for ensuring compliance with the ringfencing arrangements in this **Part 3**.
 - (c) Subject to **clause 3.19(d)**, giving a compliance declaration under **clause 3.19(a)** that is known to be false or misleading will constitute a breach of this Undertaking by Aurizon Network.
 - (d) **Clause 10.7.3(b)** applies to any compliance declaration given under **clause 3.19(a)**, including the compliance declaration signed by the Other Officer under **clause 3.19(b)**, in which case, **clause 10.7.3(b)** will be available to that person as if **clause 10.7.3(b)** names that person.

3.20 Decision making

- (a) Subject to **clause 3.20(b)**, Aurizon Network must comply with the following decision making process when making a decision under this Undertaking that will, or has the potential to, materially and adversely affect an Access Seeker's or Access Holder's rights under this Undertaking or an Access Holder's Access:
 - (i) the decision is made by an identified decision maker responsible for the relevant type of decision;
 - (ii) the decision is made in a manner that does not unfairly differentiate in a material way (as that term is defined in section 137(3) of the Act) between Access Seekers and/or Access Holders in a way that has a material adverse effect on the ability of one or more of the Access Seekers or Access Holders to compete with other Access Seekers or Access Holders; and
 - (iii) either:
 - (A) the decision is required in order to comply with:
 - (1) a Law;
 - (2) this Undertaking;
 - (3) the Access Agreements of adversely affected Access Holders; or
 - (4) an access code made under the Act; or
 - (B) the decision is made in accordance with Aurizon Network's documented policies and procedures; or

- (C) the reasons for the decision are documented by Aurizon Network.
- (b) Decisions made in relation to or to prevent an emergency are exempt from the decision making process prescribed by **clause 3.20(a)**.

Section E – Complaints and Waiver

3.21 Complaint handling

- (a) If an Access Seeker, Access Holder, Train Operator or Third Party Access Seeker (**Complainant**) considers that:
 - (i) Aurizon Network has breached one or more of its obligations under this **Part 3**;
 - (ii) the Ultimate Holding Company has breached the Ultimate Holding Company Support Deed; or
 - (iii) any of:
 - (A) Aurizon Network Personnel; or
 - (B) a Related Party of Aurizon Network or an employee, officer, agent or contractor of a Related Party of Aurizon Network,has breached a confidentiality deed or confidentiality provisions contained in another arrangement with Aurizon Network under which Confidential Information was disclosed to it,the Complainant may lodge a written complaint with Aurizon Network or the QCA or both of them and may provide a copy of any complaint lodged with Aurizon Network to the QCA.
- (b) Aurizon Network must not prevent or hinder a Complainant from providing information or documents for the purposes of its complaint to the QCA, including by invoking any rights in relation to confidentiality that would otherwise prevent the disclosure of such information or documents.
- (c) Aurizon Network must advise the QCA, as soon as practicable, of any complaints it receives pursuant to **clause 3.21(a)**.
- (d) Aurizon Network must:
 - (i) promptly investigate complaints received under **clause 3.21(a)**; and
 - (ii) advise the Complainant and the QCA in writing of the outcome of that investigation and Aurizon Network's proposed response, if any, no later than twenty (20) Business Days after receiving such a complaint.

- (e) Where the Complainant is not satisfied with the outcome of Aurizon Network's investigation, the Complainant may apply to the QCA seeking an audit of the relevant subject of the complaint. The QCA will consider such a request and determine whether to request Aurizon Network to conduct an audit in accordance with **clause 10.6.3**.
- (f) Aurizon Network must ensure that the Compliance Officer establishes and maintains a record of Aurizon Network's Complaint handling times under this **clause 3.21** for publication in the annual compliance report prepared under **Part 10** of this Undertaking.

Section F – Responsibility for Rail Infrastructure

3.22 Line Diagrams

- (a) The Line Diagrams indicate those parts of the Queensland rail network that are Rail Infrastructure provided however nothing in this **clause 3.22** or the Line Diagrams limits the definition of 'Rail Infrastructure'.
- (b) During the Term, Aurizon Network must, as necessary but at intervals of no greater than six (6) Months:
 - (i) review and amend the Line Diagrams to reflect changes that have been made to the configuration or ownership of the Rail Infrastructure; and
 - (ii) publish on Aurizon Network's Website:
 - (A) the current version of the Line Diagrams; and
 - (B) a description of the changes made since the immediately preceding version of the Line Diagrams.
- (c) If Aurizon Network:
 - (i) assigns or transfers ownership of existing or new Rail Infrastructure from Aurizon Network to an Aurizon Party; or
 - (ii) removes existing Rail Infrastructure (except where such Rail Infrastructure is already identified in the Line Diagrams for future removal) or amends the Line Diagrams to identify any existing Rail Infrastructure for future removal, except where the change:
 - (A) is minor or administrative in nature; or
 - (B) does not reflect a permanent reduction in Existing Capacity that would affect an Access Holder's Access other than in accordance with an Access Agreement or this Undertaking (for example, where

level crossings are removed or reconfigurations of Track are undertaken),

this Undertaking ceases to apply to that Rail Infrastructure, and Aurizon Network must immediately notify the QCA with details of the assignment, transfer, removal or amendment under this **clause 3.22(c)**.

- (d) If the QCA or an Access Seeker or Access Holder is reasonably of the opinion that Line Diagrams prepared and published in accordance with **clause 3.22(b)**:
- (i) do not indicate those parts of the Queensland rail network that are Rail Infrastructure; or
 - (ii) do not reflect that the Rail Infrastructure does not apply to this Undertaking in accordance with **clause 3.22(c)**,
- then the QCA or that Access Seeker or Access Holder may request in writing that Aurizon Network review and, if necessary, amend the Line Diagrams in accordance with **clause 3.22(b)**.
- (e) If Aurizon Network receives a request under **clause 3.22(d)**, Aurizon Network must:
- (i) if the QCA made the request, within thirty (30) days after receiving that request, make any necessary amendments to the Line Diagrams; and
 - (ii) if an Access Seeker or Access Holder made the request:
 - (A) promptly notify the QCA of that request;
 - (B) review the Line Diagrams;
 - (C) within thirty (30) days after receiving the request, give the QCA and the Access Seeker or Access Holder notice of whether Aurizon Network accepts the matters set out in the request and, if so, the action that Aurizon Network proposes to take; and
 - (D) make any required amendments to the Line Diagrams within fourteen (14) days after:
 - (1) where Aurizon Network has accepted the matters set out in the request, the giving of the notice under **clause 3.22(e)(ii)(C)**; or
 - (2) if there is a Dispute, the resolution of the Dispute in favour of the Access Seeker or Access Holder.
- (f) An Access Seeker or Access Holder may only refer a matter in relation to the Line Diagrams to be resolved under **Part 11**:

- (i) after Aurizon Network has notified that party in accordance with **clause 3.22(e)(ii)(C)**; or
- (ii) if Aurizon Network fails to comply with **clause 3.22(e)(ii)**.

Part 4: Negotiation framework

4.1 Overview

- (a) The granting of Access will be underpinned by an Access Agreement that will be developed and finalised as part of the negotiation framework.
- (b) This **Part 4** addresses the process by which a person may apply for, negotiate and develop an Access Agreement. In particular, under this **Part 4**:
 - (i) A Prospective Access Seeker may obtain Preliminary Information prior to submitting an application for Access from the Website or, if Capacity Information is required, by lodging a request with Aurizon Network (**clause 4.2**).
 - (ii) An Access Application by an Access Seeker must be provided in the appropriate form. By submitting an Access Application, the Access Seeker agrees to be bound by this Undertaking. Aurizon Network will provide notice of any incorrectly completed sections or missing information and may request additional evidence regarding the use of Access Rights and to assess Capacity allocation (**clause 4.3**).
 - (iii) Aurizon Network will provide an Acknowledgement Notice and confirm preparation of an IAP once additional information or a properly completed Access Application is received. In specified circumstances, the negotiation process may be suspended (**clause 4.4**).
 - (iv) Aurizon Network will develop an appropriate IAP for the Access Rights sought. The Access Seeker may notify Aurizon Network regarding concerns about the IAP (**clause 4.6**).
 - (v) An Access Seeker must notify Aurizon Network if it intends to progress its Access Application based on the arrangements within the IAP (**clause 4.7**).
 - (vi) Where Access Rights cannot be provided in the absence of an Expansion, **clause 4.8** provides a process for the separation of Access Applications and suspension of the negotiation process for Access (**clause 4.8**).
 - (vii) Where multiple Access Applications for the same Access Rights are made, **clause 4.9** provides a mechanism for determining who must be treated as the Access Seeker. In these circumstances, Aurizon Network may disclose certain information without breaching its confidentiality obligations (**clause 4.9**).

- (viii) The Negotiation Period commences once the notification of intent to progress an Access Application is provided by the Access Seeker. Specific issues are to be addressed during the Negotiation Period. Aurizon Network may provide Additional Information to the Access Seeker (**clause 4.11**).
- (ix) Aurizon Network may issue a Negotiation Cessation Notice to an Access Seeker in certain circumstances (**clause 4.13**).
- (c) A diagrammatic representation of the negotiation framework is set out in **Schedule H**.
- (d) This **Part 4** must be read in conjunction with the processes outlined in **Part 7, Part 7A** and **Part 8**.
- (e) Any Dispute regarding a decision made, or notice given, by Aurizon Network under this **Part 4** must be notified to the QCA and Aurizon Network within ten (10) Business Days after the Prospective Access Seeker, Access Seeker, Customer, Railway Operator or Train Operator (as applicable) receives notice of Aurizon Network's decision or notice and that Dispute must be dealt with under **clause 11.1**.

4.2 Initial enquiries

- (a) Prior to submitting an Access Application, a Prospective Access Seeker may meet with Aurizon Network to discuss the Access Application process and to seek clarification of the process as outlined in this Undertaking.
- (b) Aurizon Network must promptly provide Prospective Access Seekers with information regarding the Access Application process. All Preliminary Information and the application form(s) for Access Applications must be displayed on the Website.
- (c) A Prospective Access Seeker may lodge a request for Capacity Information with Aurizon Network and Aurizon Network must provide that Capacity Information within ten (10) Business Days after receiving that request.
- (d) Aurizon Network must keep the Preliminary Information and the Capacity Information current and accurate.

4.3 Access Application

- (a) Requests for Access must be submitted to Aurizon Network in the form of an Access Application.
- (b) By submitting an Access Application, the Prospective Access Seeker agrees to be bound by all the provisions of this Undertaking as they relate to Access Seekers.
- (c) If applicable, Aurizon Network must, within ten (10) Business Days after receipt of a purported Access Application, notify the Prospective Access Seeker that:

- (i) the purported Access Application has not been properly completed, including specifying the information required to make the application complete and compliant; or
- (ii) Aurizon Network (or the Independent Expert for the purpose of the assessment in **clause 8.9.1**) requests more evidence or information, to the extent reasonably required:
 - (A) regarding the Prospective Access Seeker's or Access Seeker's ability to utilise the requested Access Rights (on the basis of the factors listed in **clause 4.13(c)**);
 - (B) to satisfy Aurizon Network that the Non-availability Circumstances exist; or
 - (C) to assess the allocation of Capacity in accordance with **Part 7** and, if applicable, **Part 8**.
- (d) A person receiving a notice under **clauses 4.3(c)(i)** or **4.3(c)(ii)** must provide:
 - (i) the revised Access Application; or
 - (ii) the requested evidence or information,

within twenty (20) Business Days of Aurizon Network's notice or request, as applicable, or such other period as may be agreed.
- (e) If **clause 4.3(d)** is not complied with in any respect, Aurizon Network may notify the relevant person that Aurizon Network will take no further action in relation to the request for Access and that the request for Access is deemed to be withdrawn. A notice under this **clause 4.3(e)** does not prevent a person from submitting a new request for Access.
- (f) Without otherwise affecting Aurizon Network's discretion to give a notice under **clause 4.3(e)**, Aurizon Network must provide notice to the relevant person that it will not take any further action in relation to a request for Access if that request for Access relates to a Transfer and the evidence referred to in **clause 6** of **Schedule B** has not been provided.
- (g) If a Dispute arises in relation to this **Part 4** within a timeframe prescribed under this **clause 4.3**, including:
 - (i) the ten (10) Business Day time period outlined in **clause 4.3(c)**; or
 - (ii) the twenty (20) Business Day time period outlined in **clause 4.3(d)**,

such timeframe will be extended by the time between the issuing of a Dispute Notice and the date of resolution of the Dispute (or such longer time as may be determined by the QCA in the resolution of the Dispute and having regard to the time reasonably required to

implement the steps and matters needed to give effect to the resolution).

4.4 Acknowledgement of Access Application

- (a) Within ten (10) Business Days of receiving:
- (i) a properly completed Access Application; or
 - (ii) any further evidence or information requested under **clause 4.3(c)**,
- whichever is the later, Aurizon Network will give the relevant Prospective Access Seeker a notice (**Acknowledgement Notice**):
- (iii) acknowledging receipt of the Access Application;
 - (iv) confirming that Aurizon Network will prepare an IAP for the requested Access; and
 - (v) confirming the date Aurizon Network received the later of:
 - (A) the properly completed Access Application; or
 - (B) any further evidence or information requested under **clause 4.3(c)**,as applicable.
- (b) The Prospective Access Seeker's Access Application will be deemed to have been received for the purposes of this Undertaking on the later of the date the Prospective Access Seeker:
- (i) submits a properly completed Access Application; or
 - (ii) provides to Aurizon Network any further evidence or information requested under **clause 4.3(c)**.
- (c) Subject to the Access Seeker providing a notification of intent in accordance with **clause 4.7(a)**, if relevant, the Access Seeker will be deemed to have joined the Queue in respect of the Access Rights sought on the later of the date the Access Seeker:
- (i) submits a properly completed Access Application; or
 - (ii) provides to Aurizon Network any further evidence or information requested under **clause 4.3(c)**.
- (d) Subject to **clause 4.8**, if Aurizon Network receives an Access Application for Access Rights which commence on a date more than five (5) years after the date on which the relevant Access Application would be deemed to have been received by Aurizon Network under **clause 4.4(b)**, then Aurizon Network may reject the Access Application. Rejection of the Access Application does not restrict the relevant Access Seeker from submitting a new Access Application for the same Access Rights at a later date.

- (e) Where Aurizon Network notifies an Access Seeker that Aurizon Network rejects the Access Seeker's Access Application under **clause 4.4(d) (Rejection Notice)**:
 - (i) the rejection will take effect ten (10) Business Days after Aurizon Network gives the Rejection Notice; and
 - (ii) the Access Application is deemed to be withdrawn from the date the rejection takes effect under **clause 4.4(e)(i)**.

4.5 Revisions to an Access Application

- (a) An Access Seeker may, by written request to Aurizon Network (acting reasonably), vary its Access Application at any time after receipt of an Acknowledgement Notice in accordance with this **clause 4.5**.
- (b) If the requested variation to the Access Application is not a Material Variation, then the Access Application is varied as requested by the Access Seeker and the process under this Undertaking for the Access Application will continue provided that:
 - (i) if a variation under **clause 4.5(a)** is received prior to Aurizon Network giving an IAP to the relevant Access Seeker; and
 - (ii) Aurizon Network has already commenced preparing the IAP,Aurizon Network may, by notice to the Access Seeker, extend the date by which it must give the IAP to the Access Seeker by a period of no more than ten (10) Business Days.
- (c) If Aurizon Network considers a requested variation is a Material Variation, then Aurizon Network must, within ten (10) Business Days of receipt of the proposed variation under **clause 4.5(a)**, notify the Access Seeker of:
 - (i) its reasons for considering the variation is a Material Variation;
 - (ii) the extent to which it is possible to separate the Access Application (as varied) so that one Access Application may proceed without containing a Material Variation;
 - (iii) the extent to which the Material Variation causes or contributes to the Access Application relating to Access Rights which cannot be provided in the absence of an Expansion (after considering the Capacity Assessment);
 - (iv) the extent that Available Capacity exists which can satisfy part of the Access Rights sought by the Access Application with the proposed Material Variation (after considering the Capacity Assessment); and
 - (v) the date by when Aurizon Network (acting reasonably) estimates that it will issue an IAP or revised IAP (as applicable) to accommodate the Material Variation.

- (d) If, within five (5) Business Days after receipt of a notice under **clause 4.5(c)**, the Access Seeker:
- (i) notifies Aurizon Network that it wishes to continue with the Material Variation, subject to **clause 4.5(e)**, Aurizon Network will use reasonable endeavours to accommodate the Material Variation including by issuing an IAP or a revised IAP (as applicable) in accordance with this **clause 4.5** within a reasonable time following receipt of any information requested under **clause 4.5(f)(ii)** and having regard to all relevant circumstances including:
 - (A) the nature and extent of the Material Variation; and
 - (B) the effect that the Material Variation has, or would have had, on any processes already carried out, or to be carried out, by Aurizon Network or the Access Seeker in accordance with this **Part 4** (including the extent of inconsistency with any parameters or other information upon which a relevant Capacity Analysis has been based) or any other provision of this Undertaking,
 - (ii) notifies Aurizon Network that it requires the Access Application to be separated (so that one Access Application may proceed without a Material Variation), then:
 - (A) in respect of the Access Rights that can be provided without a Material Variation, the Access Application will be taken to be varied to that extent and the process under this Undertaking for that varied Access Application will continue in accordance with **clause 4.5(b)**; and
 - (B) in respect of the Access Rights that cannot be provided without a Material Variation:
 - (1) those Access Rights will be deemed to be the subject of a separate Access Application; and
 - (2) that separate Access Application will be deemed to be received on the date that Aurizon Network was given the notice under this **clause 4.5(d)(ii)**; and
 - (3) the process set out in **clause 4.5(d)(i)** will apply in respect of that separate Access Application; or
 - (iii) either:
 - (A) notifies Aurizon Network that it does not wish to continue with any variation to the Access Application; or

- (B) does not give Aurizon Network a notice under this **clause 4.5(d)**,
then the variation (including the Material Variation) is deemed to be withdrawn and negotiations for Access Rights outlined in this **Part 4** will proceed without the variation.
- (e) If a Material Variation causes or contributes to the Access Application relating to Access Rights which cannot be provided in the absence of an Expansion (based on an Initial Capacity Analysis) and the Access Seeker notifies Aurizon Network under **clauses 4.5(d)(i)** or **4.5(d)(ii)**, then:
 - (i) to the extent that Available Capacity exists which can satisfy part of the Access Rights sought by the Access Application with the proposed Material Variation, the IAP or revised IAP (as applicable) to be prepared under **clause 4.5(d)(i)** or **clause 4.5(d)(ii)** (as applicable) will be prepared only in relation to that portion of the Access Rights that can be provided in the absence of an Expansion and **clause 4.5(i)** will apply to that portion of the Access Rights sought which cannot be provided in the absence of an Expansion; or
 - (ii) if Aurizon Network cannot satisfy any part of the Access Rights sought by the Access Seeker without an Expansion, **clause 4.5(i)** will apply.
- (f) If an IAP or revised IAP (as applicable) must be prepared by Aurizon Network under this **clause 4.5**, then:
 - (i) it must be accompanied by or include a statement drawing to the Access Seeker's attention the requirements under **clause 4.5(g)** and the potential consequence under **clause 4.5(i)**;
 - (ii) Aurizon Network may request the Access Seeker to provide more evidence or information, to the extent reasonably required:
 - (A) regarding the Access Seeker's ability to utilise the requested Access Rights (on the basis of the factors listed in **clause 4.13(c)**); or
 - (B) to assess the allocation of Capacity in accordance with **Part 7** and, if applicable, **Part 8**;
 - (iii) the Access Seeker must provide any requested evidence or information (except to the extent the Non-availability Circumstances exist) as soon as reasonably practicable (but within no more than twenty (20) Business Days of Aurizon Network's request for that evidence or information or such other period as may be agreed); and

- (iv) if the evidence or information required to be provided by the Access Seeker under **clause 4.5(f)(iii)** is not provided to Aurizon Network within the required time period under **clause 4.5(f)(iii)**, then:
 - (A) Aurizon Network's obligations in relation to preparing the IAP or the revised IAP (as applicable) in response to the Material Variation cease;
 - (B) the Material Variation is deemed to be withdrawn; and
 - (C) negotiations for Access Rights outlined in this **Part 4** will proceed without the Material Variation.
- (g) The Access Seeker must, within ten (10) Business Days after being given the IAP or revised IAP (as applicable) issued by Aurizon Network under this **clause 4.5** in response to a Material Variation, notify Aurizon Network that it intends to continue to negotiate for Access Rights in accordance with this Undertaking either:
 - (i) on the basis of the IAP or the revised IAP (as applicable) issued by Aurizon Network under this **clause 4.5** in response to a Material Variation; or
 - (ii) without the Material Variation to the Access Application.
- (h) If an Access Seeker notifies Aurizon Network in accordance with **clause 4.5(g)(ii)**, the Material Variation is deemed to be withdrawn and the process under this **Part 4** will continue without the Material Variation.
- (i) If:
 - (i) a request to vary an Access Application was made after the relevant Access Seeker has given Aurizon Network a notification of intent under **clause 4.7** in respect of that Access Application and Aurizon Network notifies the Access Seeker under **clause 4.5(c)** that it considers all or a portion of the requested variation is a Material Variation;
 - (ii) Aurizon Network has received a notice under **clause 4.5(g)(i)** and there was a portion of the Material Variation that could not be provided in the absence of an Expansion (based on an Initial Capacity Analysis) under **clause 4.5(e)(i)**;
 - (iii) **clause 4.5(e)(ii)** applies; or
 - (iv) the Access Seeker does not notify Aurizon Network in accordance with **clause 4.5(g)**,

then the following apply:

- (v) where **clause 4.5(i)(i)** applies:
 - (A) the Material Variation is deemed to be withdrawn by the Access Seeker and, for clarity, the process under this **Part 4** will cease in respect of that Material Variation; and
 - (B) the process under this **Part 4** will continue for the Access Application;
- (vi) the relevant Access Application (including the Material Variation) or, in the case of **clause 4.5(i)(ii)**, the relevant portion of the Access Application (including the relevant portion of the Material Variation), is deemed to be withdrawn by the Access Seeker and, for clarity, the negotiation process under this **Part 4** will cease in respect of that Access Application or, in the case of **clause 4.5(i)(ii)**, the relevant portion of the Access Application; and
- (vii) except where that Access Seeker has notified Aurizon Network to the contrary, a new request for Access in respect of the whole or any part of the Material Variation or Access Application (as applicable) withdrawn under **clause 4.5(i)(v)** or **(vi)** is deemed submitted to Aurizon Network on the date of Aurizon Network's notice given under **clause 4.5(c)**, and the negotiation process for that new request for Access will start at the beginning of the process under this **Part 4**.
- (j) If a change described in **clause 4.10.1(c)(ii)** or **4.10.1(c)(iii)** constitutes a Material Variation, references in this **clause 4.5** to Access Seeker will be taken to refer to the incoming Access Seeker from the date when the incoming Access Seeker replaces the existing Access Seeker in accordance with **clause 4.10.1(c)(ii)** or **4.10.1(c)(iii)** as applicable.
- (k) Subject to **clause 4.5(i)**, the negotiation process under this **Part 4** is suspended for the period:
 - (i) from (and including) the time that the Access Seeker requested the Material Variation; and
 - (ii) until (and including) the time when:
 - (A) the request for Material Variation is deemed to be withdrawn under **clauses 4.5(d)(iii)**, **4.5(f)(iv)(B)** or **4.5(h)**; or
 - (B) following the issue of an IAP or revised IAP in response to the Material Variation under this **clause 4.5**, Aurizon Network is notified under **clause 4.5(i)**,

(Suspension Period).

4.6 Indicative Access Proposal

- (a) Aurizon Network will have regard to the information received and assess the Access Application to develop an IAP for the type of Access Rights being sought and having regard to:
 - (i) the Capacity Assessment;
 - (ii) for the period following the Initial Capacity Assessment Report being published by the QCA on its website as contemplated by **clause 7A.4.1(h)**, advice from the Independent Expert as to whether a constraint identified in the Capacity Assessment can be mitigated other than through an Expansion; and
 - (iii) the appropriate form of Access Agreement referred to in **clause 5.1(c)**.
- (b) If an Access Application is received by Aurizon Network and Aurizon Network considers (acting reasonably) that the Capacity is constrained, as soon as practicable or in any case no later than the date of the provision of the IAP or revised IAP, Aurizon Network must advise the Access Seeker of this and, to the extent that the relevant information is available at the relevant time, provide reasons why such constraint cannot be mitigated except through an Expansion.
- (c) The IAP will outline:
 - (i) the Rollingstock and Rollingstock Configuration;
 - (ii) the relevant operating characteristics;
 - (iii) an Initial Capacity Analysis (which is subject to confirmation by a Capacity Analysis prepared in accordance with **clause 4.11.2(a)(v)**) together with Aurizon Network's or the Independent Experts' assumptions (as applicable) regarding Rollingstock, section run times and loading and unloading times used in preparing that assessment (but, for clarity and efficiency, Aurizon Network must use all or part of any Capacity Assessment to the extent that it is appropriate to do so);
 - (iv) whether any other requests for Access exist that, if approved, would affect Aurizon Network's ability to grant the Access Rights sought by the Access Seeker;
 - (v) an initial estimate of the Access Charge applicable to the Train Service proposed and details of how the initial estimate has been calculated, including where **clauses 6.2.2, 6.2.3 or 6.2.4** apply details of how those clauses have been applied in calculating the initial estimate;

- (vi) details of any further information reasonably required from the Access Seeker in preparation for the negotiation stage; and
 - (vii) where the grant of Access Rights will require the construction of an Expansion, information identifying the likely need for an Expansion and identifying the Expansion, including likely timeframes, to the extent that this information exists and is reasonably available to, and can lawfully be provided by, Aurizon Network.
- (d) The IAP contains indicative arrangements only and does not oblige Aurizon Network to provide Access.
- (e) Subject to any suspension of the negotiation process under **clauses 4.5(k) or 4.8(d)** occurring before the IAP is provided to the Access Seeker, or an extension of the relevant date under **clause 4.5(b)**, Aurizon Network will provide the IAP to the Access Seeker:
- (i) in circumstances where the Initial Capacity Assessment Report has not yet been published by the QCA on its website, within twenty (20) Business Days of the date of the Acknowledgement Notice.

However, where, due to the complexity of the Access Application or other extenuating circumstances, it is not reasonable to provide an IAP within that period, Aurizon Network may, by notice to the Access Seeker (to be given as soon as practicable and in any case no later than fifteen (15) Business Days after the Acknowledgement Notice), extend the period for the giving of an IAP by up to a further twenty (20) Business Days. This period may be further extended by agreement between Aurizon Network and the Access Seeker; or
 - (ii) in circumstance where the Initial Capacity Assessment Report has been published by the QCA on its website, such longer period that may be required for the Independent Expert to certify that there is sufficient Available Capacity to provide the Access Rights sought in the Access Application, or that required Capacity can be created by an Expansion undertaken in accordance with **Part 8**.
- (f) Unless otherwise agreed by Aurizon Network and the Access Seeker, the IAP expires sixty (60) Business Days after the later of:
- (i) the date of its provision to the Access Seeker; and
 - (ii) the date of issue of a revised IAP (if any) under **clause 4.6(h)**,

provided that where:

- (iii) the negotiation process has been suspended under **clause 4.5(k)** or **clause 4.8(d)**; and
- (iv) Aurizon Network provided the IAP to the Access Seeker prior to that suspension commencing,

the expiry date is extended by the period during which the negotiation process was suspended.

- (g) If the Access Seeker believes, acting reasonably, that the IAP has not been prepared in accordance with this Undertaking and would therefore not be an appropriate basis for continuing with the negotiation process under this Undertaking, the Access Seeker will notify Aurizon Network of its concerns within twenty (20) Business Days of being provided with the IAP, or such other timeframe as Aurizon Network and the Access Seeker agree.
- (h) Aurizon Network will respond to the concerns of any Access Seeker notified under **clause 4.6(g)** including, where appropriate, by making revisions to the IAP:
 - (i) within ten (10) Business Days after being notified under **clause 4.6(g)**; or
 - (ii) if due to the complexity of the concerns or other extenuating circumstances it is not reasonable to provide a response within that ten (10) Business Day period, a reasonable period notified by Aurizon Network to the Access Seeker within five (5) Business Days after the Access Seeker's notice to Aurizon Network under **clause 4.6(g)**.
- (i) If a Dispute arises in relation to this **Part 4** within a timeframe prescribed under this **clause 4.6**, including (but not limited to):
 - (i) the time period outlined in **clause 4.6(e)** (or, if extended in accordance with that clause, such extended timeframe); and
 - (ii) the sixty (60) Business Day time period outlined in **clause 4.6(f)** (or, if extended in accordance with that clause, such extended timeframe),

such timeframe will be extended by the time between the issuing of a Dispute Notice and the date of resolution of the Dispute (or such longer time as may be determined by the QCA in the resolution of the Dispute and having regard to the time reasonably required to implement the steps and matters needed to give effect to the resolution). Aurizon Network has no obligation to produce an IAP for an Access Seeker that notifies Aurizon Network that the Access Seeker no longer wishes to proceed with its Access Application.

4.7 Notification of intent

- (a) If an Access Seeker intends to progress its Access Application on the basis of the arrangements outlined in the IAP, the Access Seeker

must notify Aurizon Network of its intention prior to the expiry of the IAP in accordance with **clause 4.6(f)**. Notification must be in the form set out in the IAP.

- (b) Where an Access Seeker does not notify Aurizon Network under **clause 4.7(a)**, the Access Application and the IAP are deemed to be withdrawn on the IAP's expiry date.

4.8 Access Applications that require Expansions

- (a) If an Access Application is received by Aurizon Network which is, in part, for Access Rights which cannot be provided in the absence of an Expansion (which must be based on the Initial Capacity Analysis), Aurizon Network must notify the Access Seeker of the portion of the Access Rights being sought which can be provided without an Expansion as soon as practicable or in any case no later than the date of the provision of the IAP under **clause 4.6(e)**.
- (b) Within five (5) Business Days of receipt of notice from Aurizon Network under **clause 4.8(a)**, the Access Seeker must notify Aurizon Network whether or not it requires the Access Application to be separated as contemplated by this clause.
- (c) If the Access Seeker elects for the Access Application to be separated:
 - (i) the Access Rights that can be provided without an Expansion will:
 - (A) be deemed to be the subject of one Access Application made on the date the Access Seeker's original Access Application was deemed to be received under **clause 4.4(b)**; and
 - (B) proceed in accordance with the process under this **Part 4**.
 - (ii) the Access Rights that can be provided only with an Expansion will be deemed to be the subject of a second Access Application made on the date the Access Seeker's original Access Application was deemed to be received under **clause 4.4(b)**; and
 - (iii) the separation of the Access Application into two Access Applications will occur without having to follow the process under **clause 4.5**.
- (d) The following provisions will apply where the Access Seeker elects that the Access Application will not be separated and in respect of the second Access Application referred to in **clause 4.8(c)(ii)** or where an Access Application is received by Aurizon Network in respect of Access Rights which can only be provided with an Expansion:
 - (i) **clauses 8.2 to 8.9** will apply;

- (ii) the negotiation process for Access may be suspended (before or after the provision of an IAP) by either Aurizon Network or the relevant Access Seeker giving notice to the other (provided that a notice given under this clause must give reasons for the suspension); and
- (iii) a suspension of the negotiation process under **clause 4.8(d)(ii)** continues until the date that:
 - (A) without limiting Aurizon Network's obligation in **clause 8.2.1(b)(ii)**, Aurizon Network and the Access Seeker enter into an agreement as to how an Expansion is to be funded in accordance with **clause 8.2.1(c)(ii)**;
 - (B) a determination of a Dispute as contemplated by **clause 8.2.2(a)**; or
 - (C) Aurizon Network and the Access Seeker agree to restart or continue negotiations for Access in parallel with any negotiations over funding of the required Expansion.
- (e) When the negotiation process is suspended in accordance with **clause 4.8(d)(ii)**, Aurizon Network:
 - (i) may request at intervals not more than every six (6) Months that the Access Seeker confirm, in writing:
 - (A) the Access Seeker's ongoing requirement for the Access Rights;
 - (B) the reasonable likelihood that the Access Seeker will be able to utilise the requested Access Rights at the proposed date of commencement of those Access Rights (on the basis of the factors listed in **clause 4.13(c)**) and provide any relevant information or evidence requested by Aurizon Network (acting reasonably); and
 - (C) any material change to the information contained in their Access Application or provided in respect of the matters referred to in **clause 4.3(d)**; and
 - (ii) must, as soon as practicable, notify the Access Seeker of any changes to an Expansion that will impact the proposed timing or provision of Access relevant to the Access Seeker's Access Application.
- (f) If the document or information referred to in **clause 4.8(e)(i)** is not provided to Aurizon Network within the period that is twenty (20) Business Days after Aurizon Network's request, Aurizon Network may notify the relevant person that Aurizon Network will take no further action in relation to the request for Access and that the request for

Access is deemed to be withdrawn. A notice under this **clause 4.8(f)** does not prevent a person from submitting a new request for Access.

- (g) Where a Provisional Capacity Allocation (as defined under **clause 8.5(b)(ii)**) has been granted to an Access Seeker, Aurizon Network may, acting reasonably and in good faith, suspend negotiations with other Access Seekers for Access Rights which, if the holder of the Provisional Capacity Allocation executes an Access Agreement in respect of the Provisional Capacity Allocation, cannot be provided in the absence of an Expansion, pending the outcome of negotiations with the holder of the Provisional Capacity Allocation.

4.9 Multiple applications for the same Access

- (a) If more than one party has submitted an Access Application for the same Access Rights and:
 - (i) one of the parties that has applied for Access is the Customer Access Seeker:
 - (A) this Undertaking and Aurizon Network will treat the Customer Access Seeker as the sole Access Seeker and the other relevant Access Seekers' Access Applications for the same Access Rights as having been withdrawn; and
 - (B) Aurizon Network must negotiate solely with that Customer Access Seeker; or
 - (ii) the only parties that applied for Access are Railway Operators then, to the extent that each Railway Operator is either:
 - (A) currently engaged in negotiations with a Customer in respect of a potential haulage agreement in respect of the Access Rights being sought; or
 - (B) a party to an existing haulage agreement with the Customer in respect of the Access Rights being sought;

then:

 - (C) this Undertaking and Aurizon Network will treat the Railway Operators as Access Seekers; and
 - (D) Aurizon Network will negotiate with each of those Railway Operators until an alternative Railway Operator is (or Railway Operators are) nominated in writing by the Customer to Aurizon Network.

- (b) Notwithstanding any other provision in this **Part 4**, if **clause 4.9(a)(ii)** applies, Aurizon Network is not obliged to enter into an Access Agreement with a Railway Operator until a nomination for a Railway Operator is received from the relevant Customer.

- (c) Aurizon Network may, for the purpose of **clause 4.9(a)**, disclose to the Customer that an Access Application by an Access Seeker in respect of that Customer has been received (that disclosure will not constitute a breach of the confidentiality obligations owed by Aurizon Network under **Part 3**).
- (d) Access Applications that constitute:
 - (i) Mutually Exclusive Access Applications will be dealt with in accordance with **clause 7.5**; and
 - (ii) Competing Applications will be dealt with in accordance with **clause 7.5.2(c)**.

4.10 Requirements for Customers, Customer Access Seekers and Train Operators

4.10.1 Customers and Customer Access Seekers

- (a) A Customer Access Seeker may (in its absolute discretion) give notice to Aurizon Network nominating a Railway Operator (**Nominee Operator**) to act on its behalf for the purpose of assisting the Customer Access Seeker with its Access Application including in negotiations with Aurizon Network for the requested Access. Unless the Customer Access Seeker's nomination expressly indicates otherwise or the nomination is revoked by notice to Aurizon Network:
 - (i) the Nominee Operator will, for the purpose of this Undertaking, be taken to be the Customer Access Seeker's agent in relation to the Access Application including for the giving of any notices that may or are required to be given under this Undertaking (but not for the execution of any Access Agreement or other agreement); and
 - (ii) despite any other provision to the contrary in this Undertaking, any information disclosed to the Nominee Operator by Aurizon Network or disclosed to Aurizon Network by the Nominee Operator will be treated as though it was disclosed to or by the Customer Access Seeker, as applicable.
- (b) If Aurizon Network receives notices from both the Nominee Operator and the Customer Access Seeker in respect of the same requirement under this Undertaking or the same subject matter, the Nominee Operator's notice is of no effect and will be disregarded by Aurizon Network.
- (c) At any time during negotiations under this **Part 4**:
 - (i) a Customer Access Seeker may withdraw any nomination made under **clause 4.10.1(a)** or replace that nomination by nominating a different Railway Operator to act on its behalf;

- (ii) a person may take over an Access Seeker's Access Application where that person is the Customer for that Access Seeker; or
 - (iii) a Customer Access Seeker may nominate a Railway Operator to take over the Customer Access Seeker's Access Application and replace the Customer Access Seeker as the Access Seeker for that Access Application,
by notice to Aurizon Network and to the relevant Railway Operator or Access Seeker (as applicable).
- (d) From the date on which Aurizon Network is given a notice under:
- (i) **clause 4.10.1(c)(i)** withdrawing a nomination, the relevant Railway Operator will cease to be a Nominee Operator for the purpose of **clause 4.10.1(a)** and Aurizon Network must immediately cease providing the Railway Operator with any information in respect of the relevant Access Application;
 - (ii) **clause 4.10.1(c)(i)** nominating a different Railway Operator, that Railway Operator will become the Nominee Operator (replacing the Railway Operator who was previously nominated) for the purpose of **clause 4.10.1(a)** and Aurizon Network must immediately cease providing the exiting Railway Operator with any information in respect of the relevant Access Application;
 - (iii) **clause 4.10.1(c)(ii)**, the Customer will become the Access Seeker (replacing the existing Access Seeker) for the relevant Access Application; or
 - (iv) **clause 4.10.1(c)(iii)** and a notice from the relevant Railway Operator accepting the Customer Access Seeker's nomination, the Railway Operator will become the Access Seeker (replacing the existing Customer Access Seeker) for the relevant Access Application.
- (e) If a person becomes the Access Seeker for an Access Application (replacing the existing Access Seeker) under **clause 4.10.1(d)(iii)** or **(iv)** (as applicable), that person by doing so agrees to be bound by all the provisions of this Undertaking as they relate to Access Seekers.
- (f) If a transfer of an Access Application occurs in accordance with **clause 4.10.1(d)(iii)** or **(iv)**, then:
- (i) Aurizon Network must provide the incoming Access Seeker with a copy of:
 - (A) the Access Application;
 - (B) notices and other documents (including any IAP) given to or by the outgoing Access Seeker by or to Aurizon Network as expressly required to be given in accordance with this Undertaking; and

- (C) any other documents exchanged between Aurizon Network and the outgoing Access Seeker that are material to the Access Application and any related negotiations,
 - except to the extent that providing that information would:
 - (D) be in breach of Aurizon Network's confidentiality obligations under **Part 3**; or
 - (E) disclose information to the incoming Access Seeker that is commercially sensitive to the outgoing Access Seeker or that is not required to be disclosed to the incoming Access Seeker in order to progress the Access Application (or both); and
- (ii) on Aurizon Network's written request, the incoming Access Seeker must provide to Aurizon Network or procure for Aurizon Network:
 - (A) appropriate replacement information to the extent reasonably required; or
 - (B) authority from the outgoing Access Seeker that Aurizon Network may continue to use the relevant information provided by the outgoing Access Seeker in relation to the Access Application and any related negotiations.

4.10.2 Train Operators

- (a) A request by a prospective Train Operator for Aurizon Network to enter into a Train Operations Deed must be provided in writing and:
 - (i) identify the relevant Access Holder (or Access Seeker) and, if that Access Holder (or Access Seeker) is the Train Operator, also identify the relevant Customer; and
 - (ii) contain the information required by an Access Application and any other information reasonably required by Aurizon Network to assess the request and complete the Train Operations Deed.
- (b) A negotiation process will apply to the prospective Train Operator as specified in **clause 4.11**.
- (c) By submitting a request under **clause 4.10.2(a)**, the prospective Train Operator agrees to be bound by all the provisions of this Undertaking as they relate to Train Operators.

4.11 Negotiation process

4.11.1 *Negotiation Period*

- (a) A Negotiation Period in respect of:
 - (i) an Access Seeker's Access (including negotiation of the terms and conditions of the relevant Access Agreement in accordance with **Part 5**) commences on the date on which the Access Seeker notifies Aurizon Network in accordance with **clause 4.7**; and
 - (ii) a Train Operator's Train Operations Deed commences on the date that Train Operator has provided to Aurizon Network all of the relevant information referred to in **clause 4.10.2**.
- (b) Once the Negotiation Period has commenced, the Access Seeker or Train Operator, as applicable, and Aurizon Network will begin negotiations as soon as reasonably possible in relation to an Access Agreement or Train Operations Deed (as applicable).
- (c) If the Access Seeker or Train Operator, as applicable, and Aurizon Network are required to comply with **clause 6.13**, the negotiation process under this **Part 4** will be suspended with effect on and from the date of submission of a report by Aurizon Network to the QCA in accordance with **clause 6.13.2(a)** until the date of receipt of a decision by the QCA, in accordance with **clause 6.13.2**, to either approve or refuse to approve the proposed Access Conditions.
- (d) An Access Seeker's Negotiation Period ceases on:
 - (i) the execution of an Access Agreement in respect of the Access sought by the Access Seeker;
 - (ii) Aurizon Network receiving notification by the Access Seeker that it no longer wishes to proceed with its Access Application;
 - (iii) Aurizon Network issuing a Negotiation Cessation Notice to the Access Seeker under **clause 4.13(a)**;
 - (iv) the date:
 - (A) nine (9) Months after the commencement of the Negotiation Period except where either **clause 4.11.1(d)(iv)(B)** or **clause 4.11.1(d)(iv)(C)** applies;
 - (B) where the negotiation process has been suspended in accordance with **clause 4.5(k)** or **clause 4.11.1(c)**, nine (9) Months, plus the number of days of the Suspension Period, after the commencement of the Negotiation Period; or

- (C) where Aurizon Network issues an IAP to the Access Seeker under **clause 4.6(e)(i)** and the Independent Expert has not provided an analysis of Available Capacity, nine (9) Months, plus the number of days taken by the Independent Expert to complete the analysis of Available Capacity, after the commencement of the Negotiation Period,
 - unless:
 - (D) both parties agree to extend the Negotiation Period, in which case the Negotiation Period will continue until the expiry of the agreed extended period; or
 - (E) a Dispute arises between the parties in relation to this **Part 4** within the Negotiation Period, in which case, the Negotiation Period will, subject to **clause 4.13**, be extended by the time between the issuing of a Dispute Notice and the date of the resolution of the Dispute (or such longer time as may be determined by the QCA in the resolution of the Dispute and having regard to the time reasonably required to implement the steps and matters needed to give effect to the resolution); or
- (v) subject to **clause 4.11.1(e)**, Aurizon Network no longer being able to offer Access to the Access Seeker under the terms of the IAP, either because of:
 - (A) Available Capacity being reduced;
 - (B) Infrastructure Enhancements subsequently committed to adversely impacting the ability to develop Infrastructure Enhancements contemplated by the IAP;
 - (C) the most recent Capacity Analysis confirming that there is insufficient Available Capacity to offer Access to the Access Seeker; or
- (vi) as otherwise provided in accordance with this Undertaking.
- (e) If:
 - (i) Aurizon Network can no longer offer Access to the Access Seeker under the terms of the relevant IAP because of a reason set out in **clause 4.11.1(d)(v)(A), 4.11.1(d)(v)(B) or 4.11.1(d)(v)(C)**; and
 - (ii) either the remaining Available Capacity can satisfy part of the Access Rights sought by the Access Seeker or the contemplated Infrastructure Enhancements can be altered to provide all or part of the Access Rights sought,

Aurizon Network will notify the Access Seeker of that event and the portion of the Access Rights being sought which can be provided and:

- (iii) in that notice, to the extent possible on an unredacted basis but aggregated so as to avoid disclosing the information that is confidential and unable to be disclosed, provide the Access Seeker with an objective, evidence-based explanation as to why Available Capacity is being reduced or Infrastructure Enhancements subsequently committed to adversely impacting the ability to develop Infrastructure Enhancements contemplated by the IAP;
- (iv) if requested by the Access Seeker within ten (10) Business Days after the Access Seeker is given such a notice, prepare and issue to the Access Seeker a revised IAP in accordance with **clause 4.6** in relation to that portion of the Access Rights that can be provided; and
- (v) if, within ten (10) Business Days after being given the revised IAP, the Access Seeker notifies Aurizon Network that it intends to continue to negotiate for Access Rights on the basis of the revised IAP, the negotiation process outlined in this **Part 4** will recommence from that point.

Aurizon Network's obligation under this **clause 4.11.1(e)**, to the extent that it relates to Infrastructure Enhancements, is subject to Aurizon Network's obligations under **Part 8** and Aurizon Network is not required to do anything in accordance with this **clause 4.11.1(e)** that would cause or contribute to it failing to comply with **Part 8**.

- (f) For clarity:
 - (i) to the extent that all or part of the Access Rights sought by the Access Seeker cannot be provided due to there being insufficient remaining Available Capacity or the contemplated Infrastructure Enhancements cannot be sufficiently altered as contemplated by **clause 4.11.1(e)(ii)**;
or
 - (ii) the negotiation process is not recommenced under **clause 4.11.1(e)(v)** in respect of all or part of the Access Rights sought by the Access Seeker,

then the Negotiation Period in respect of those relevant Access Rights will have ceased and any future request by the Access Seeker in respect of those Access Rights will be treated as a new Access Application.

- (g) A Train Operator's Negotiation Period ceases on:
 - (i) the execution of the Train Operations Deed;

- (ii) Aurizon Network receiving notification by the Train Operator that it no longer wishes to negotiate or enter into the Train Operations Deed;
- (iii) Aurizon Network issuing a Negotiation Cessation Notice to the Train Operator under **clause 4.13**;
- (iv) the expiration of nine (9) Months from the date that the Train Operator is nominated by the relevant Access Holder or Access Seeker, as the case may be, unless:
 - (A) both parties agree to extend the Negotiation Period (provided however that Aurizon Network must agree to extend the Negotiation Period in circumstances where the Negotiation Period for the corresponding Access Agreement has been extended under **clause 4.11.1(d)(iv)(B)** or **clause 4.11.1(d)(iv)(C)**), in which case the Negotiation Period will continue until the expiry of the agreed extended period; or
 - (B) a Dispute arises between the parties in relation to this **Part 4** within the Negotiation Period, in which case, the Negotiation Period will, subject to **clause 4.13**, be extended by the time between the issuing of a Dispute Notice and the date of the finding (or such longer time as may be determined by the QCA in the resolution of the Dispute);
- (v) the Access Seeker being given a Negotiation Cessation Notice in respect of its Access Application and that Negotiation Cessation Notice has taken effect in accordance with **clause 4.13**; or
- (vi) a notice is given by Aurizon Network under **clause 4.12(d)**.

4.11.2 Issues to be addressed during negotiation

- (a) During the Negotiation Period, Aurizon Network and the Access Seeker or Train Operator, as applicable, will negotiate and endeavour to agree on the elements comprising, for an Access Seeker, the relevant form of Access Agreement referred to in **clause 5.1(c)** for the type of Access Rights being sought or, for a Train Operator, the matters to be completed in the relevant Train Operations Deed. In order to facilitate this process:
 - (i) an Access Seeker must (if it has not done so already) nominate its Train Operator by notice to Aurizon Network;
 - (ii) Aurizon Network must provide to the Access Seeker Additional Information (together with any requested Capacity Information) relevant to the rail corridor applicable to the Access Seeker's Access Application and that information

- must be the most current available to Aurizon Network and be provided within a reasonable timeframe;
- (iii) the Access Seeker (or its nominated Train Operator) must prepare an Operating Plan;
 - (iv) Aurizon Network must provide an Access Charge, determined in accordance with the pricing principles set out in **Part 6**, including advice as to whether Aurizon Network has applied **clause 6.3** or **clause 6.4** in determining the Access Charge and if so:
 - (A) the factor associated with the Access Seeker's proposed Access that results in a different cost or risk to Aurizon Network;
 - (B) the impact that the factor has on the Access Charge; and
 - (C) how that impact on the Access Charge was determined;
 - (v) Aurizon Network must:
 - (A) undertake a Capacity Analysis or have regard to the Deliverable Network Capacity Analysis (as applicable); and
 - (B) undertake an investigation of operational impacts and any Expansions necessary to accommodate the Access being sought;
 - (vi) Aurizon Network must provide the definition of the relevant Train Service Entitlement and, where applicable, the initial timetable for the proposed Train Services; and
 - (vii) the Access Seeker (or its nominated Train Operator) must demonstrate that the Rollingstock and Rollingstock Configurations for which the Access Rights are applicable are subject to certificates of compliance or a Compliance Statement (as that term is defined in the Train Operations Deed), as applicable, with the Rollingstock Interface Standards.
- (b) Without limiting the matters that an Access Seeker or a Train Operator and Aurizon Network may address during the Negotiation Period, Aurizon Network (jointly with the Access Seeker or Train Operator) will, or will commence to, conduct an Interface Risk Assessment and prepare an IRMP during the Negotiation Period in accordance with the provisions set out in a Standard Access Agreement or a Standard Train Operations Deed (as applicable) in respect of such matters:
- (i) if requested by the Access Seeker or Train Operator; and

- (ii) it is reasonably necessary to do so prior to the Access Seeker or Train Operator and Aurizon Network executing an Access Agreement or Train Operations Deed, as applicable.
- (c) It would be reasonably necessary to conduct an Interface Risk Assessment for the purposes of **clause 4.11.2(b)** in the following circumstances:
 - (i) the relevant Access relates to the transportation of coal from a new mine or load out facility;
 - (ii) the Access Seeker (or, the relevant Train Operator) is seeking to operate new Rollingstock, is not an Access Holder or is not currently operating Rollingstock on the Rail Infrastructure; or
 - (iii) the proposed operation, movement, provisioning or other operational aspects of the Train Services or proposed Rollingstock relating to the requested Access Rights will differ from existing Train Services operated on the Rail Infrastructure by the Access Seeker (or the relevant Train Operator) including where:
 - (A) there are reversing or special shunting movements that will be necessary for the proposed Train Services;
 - (B) there is a different driver methodology that applies to, or number of train drivers for, the Trains for the proposed Train Services;
 - (C) the Trains for the proposed Train Services will have a different operating direction (including loading or unloading direction) from that which the relevant Rail Infrastructure, loading or unloading facility or other relevant infrastructure was designed for (for example, entering a balloon loop in the opposite direction to what the balloon loop was designed for);
 - (D) the Trains for the proposed Train Services are proposed to operate at a speed greater than any speed limit or speed restriction that applies at any point on the Rail Infrastructure to be used by the Train Services;
 - (E) the proposed Train Services will not be able to meet nominated section running times for the relevant Reference Train Service or, if there is no relevant Reference Train Service, the section running times that typically apply to the relevant Rail Infrastructure;

- (F) the Rail Infrastructure is required to be extended, enhanced, expanded, augmented, duplicated or replaced in order for the relevant Access Rights to be used – for example, the installation of open door sensors; and
 - (G) there has been a change in the Access Seeker's (or relevant Train Operator's) or Aurizon Network's accreditation or Safety Management System under the Rail Safety Act.
- (d) During the Negotiation Period, Aurizon Network may seek further information that is reasonably required to address any matters referred to in this **clause 4.11.2** or information or evidence of the Access Seeker's ability to utilise the requested Access Rights (on the basis of the factors listed in **clause 4.13(c)**) and from other providers of infrastructure to be used as an entry or exit point to the Rail Infrastructure, such as owners or operators of unloading facilities. The Access Seeker must provide the information and evidence requested within twenty (20) Business Days of the request (or such other period as may be agreed with Aurizon Network) and facilitate the provision of such information from Third Parties, as applicable.
- (e) The Access Seeker does not fail to comply with a request by Aurizon Network under **clause 4.11.2(d)** where the Non-availability Circumstances are satisfied.
- (f) In respect of the details required to be developed by the parties in accordance with **clauses 4.11.2(a)** and **4.11.2(b)**, the parties may agree, for example:
- (i) to finalise certain aspects after the execution of the Access Agreement or the Train Operations Deed, as applicable;
 - (ii) to make the commencement of Train Services under the Access Agreement or the Train Operations Deed, as applicable, subject to the satisfaction of conditions (including, for example, the completion of schedules to the Access Agreement or the securing of access rights to an unloading facility or the securing of access to adjoining infrastructure); or
 - (iii) to include mechanisms in the Access Agreement or the Train Operations Deed, as applicable, to address any subsequent cost or operating impacts arising in connection with the matters referred to in **clauses 4.11.2(f)(i)** and **4.11.2(f)(ii)** that have not been expressly addressed either as part of the relevant Reference Train Service or in the negotiation of the relevant Access Agreement or Train Operations Deed.

4.12 Negotiation of Access Agreements and Train Operations Deeds

- (a) Each Access Holder or Access Seeker:

- (i) may be present and participate in any negotiation between Aurizon Network and a Train Operator for a Train Operations Deed (and Operating Plan) in respect of the Access Holder's Access Rights (or Access Seeker's proposed Access Rights);
 - (ii) may not participate in negotiations between Aurizon Network and a Train Operator that relate to Access Rights for a different Access Holder or Access Seeker; and
 - (iii) may require Aurizon Network to permit its Train Operator to be present at, and participate in, all negotiations between Aurizon Network and the Access Holder or Access Seeker for Access Rights proposed to be wholly or partially utilised by that Train Operator.
- (b) In negotiating an Access Agreement and for the purposes of this **Part 4**, if the Access Holder or Access Seeker does not provide required information regarding Rollingstock and Rollingstock Configurations for the required Train Services, Aurizon Network may assume:
- (i) a Reference Train Service in respect of the Rollingstock and Rollingstock Configurations; and
 - (ii) such other Above Rail operational matters as are reasonably necessary (having regard to any existing standard manner of conducting Above Rail Services on the relevant parts of the Rail Infrastructure).
- (c) If one or more Train Operations Deeds are negotiated between Aurizon Network and the relevant Train Operator(s), the Train Operations Deed(s) must not (alone, or in aggregate if there is more than one) grant rights to utilise the Rail Infrastructure that exceed the corresponding Access Rights granted, or to be granted, to the relevant Access Holder or Access Seeker.
- (d) If, for whatever reason (except by reason of execution of the Access Agreement):
- (i) negotiations in respect of the Access Agreement expire or are terminated;
 - (ii) the Access Seeker ceases to be an Access Seeker in respect of the Access Rights that relate to the relevant Train Operations Deed; or
 - (iii) where the Access Holder has already executed an Access Agreement, the Access Holder ceases to be an Access Holder in respect of the Access Rights that relate to the relevant Train Operations Deed,
- then Aurizon Network will, by notice to the Train Operator, terminate its negotiations in respect of the corresponding Train Operations Deed.

4.13 Cessation of negotiations

- (a) At any time during a Negotiation Period, Aurizon Network (acting reasonably):
 - (i) may give a Negotiation Cessation Notice to an Access Seeker or a Train Operator, as applicable, if:
 - (A) the Access Seeker or Train Operator, as applicable, fails to comply (after being issued with any notices required under this Undertaking) with the relevant obligations and processes contained in this Undertaking, and such non-compliance is material;
 - (B) there is no reasonable likelihood that the Access Seeker or the Train Operator will comply with the terms and conditions of an Access Agreement or Train Operations Deed, as applicable, in a material way;
 - (C) the Access Seeker or its Train Operator, as applicable, fails to comply with **clause 4.8(e)**;
 - (D) the Access Seeker or Train Operator, as applicable, has no genuine intention of obtaining Access Rights or has no reasonable likelihood of utilising Access at the level sought;
 - (E) subject to **clause 11.1.4(h)**, the Access Seeker or Train Operator, as applicable, does not comply with a determination of an expert in accordance with **clause 11.1.4**; or
 - (F) the Access Seeker or the Train Operator, as applicable, does not comply with a determination of the QCA under **clause 11.1.5** in relation to a Dispute, and
 - (ii) must give a Negotiation Cessation Notice to an Access Seeker where:
 - (A) the Access Seeker's Customer notifies Aurizon Network that they no longer agree to the Access Seeker negotiating an Access Agreement based on the transport of their coal; or
 - (B) if the relevant Access Application relates to a Transfer, either the Customer of the Access Holder that holds the Transferred Access Rights (if any) or the Transferee's Customer (if any) notifies Aurizon Network that they no longer agree to the Transfer.

For clarity, an Access Holder's or Access Seeker's negotiations of an Access Agreement are not affected if negotiations of a Train Operations Deed between Aurizon Network and a Train Operator nominated by the Access Holder or Access Seeker under **clause 4.9(a)(ii)(D)** cease.

- (b) Without limitation to **clause 4.13(a)(i)(B)**, **clause 4.13(a)(i)(B)** is deemed satisfied, if:
 - (i) the Access Seeker or the Train Operator, as applicable, is subject to an Insolvency Event; or
 - (ii) the Access Seeker or the Train Operator, as applicable, or a Related Party of the Access Seeker or Train Operator, is currently, or has in the previous two years been, in Material Default of:
 - (A) any Access Agreement or Train Operations Deed, as applicable; or
 - (B) any other agreement where its performance under that other agreement is relevant to its likely performance under any proposed Access Agreement or Train Operations Deed, as applicable.
- (c) Without limitation to **clause 4.13(a)(i)(D)**:
 - (i) **clause 4.13(a)(i)(D)** is deemed satisfied in relation to an Access Seeker or Train Operator (as applicable) in relation to coal carrying Train Services, where:
 - (A) for an Access Seeker in respect of the negotiation of an Access Agreement, the Access Seeker:
 - (1) is seeking Access Rights that will be used for a person other than the Access Seeker (that is, a person who will be a Customer); and
 - (2) has no reasonable likelihood of having a Customer for those Access Rights (provided that any consideration of reasonable likelihood must disregard the effect of granting the Access Rights to the Access Seeker on the Access Seeker's ability to attract a Customer in the future); or
 - (B) for a Train Operator in respect of the negotiation of a Train Operations Deed, the Train Operator ceases to be a Train Operator for the relevant Access Seeker or Access Holder; or
 - (ii) where **clause 4.13(c)(i)** does not apply, the following factors must be considered in relation to whether **clause 4.13(a)(i)(D)** is satisfied:

- (A) whether the Access Seeker (or its Customer) has secured, or is reasonably likely to secure, Supply Chain Rights;
 - (B) whether the Access Seeker, if not a Railway Operator, has secured, or is reasonably likely to secure, a rail haulage agreement for the operation of the Train Services the subject of the Access Application or if a Railway Operator has entered into, or is reasonably likely to enter into, a rail haulage agreement with a Customer for the use of Access Rights sought (provided that any consideration of the reasonable likelihood must disregard the effect of granting the Access Rights to the Railway Operator on the Railway Operator's ability to attract a Customer in the future);
 - (C) whether the Access Seeker or a Railway Operator is reasonably likely to have facilities (including Rollingstock, provisioning facilities, maintenance facilities and storage facilities) to enable it to run Train Services to utilise the Access Rights sought;
 - (D) whether the Train Operator no longer meets the criteria outlined in **clauses 4.9(a)(ii)(A) and 4.9(a)(ii)(B)**; and
 - (E) where the Access Rights are sought to transport the output of a mine, whether the anticipated output of the mine is reasonably likely to support utilisation of the Access Rights sought and all relevant existing Access Rights relevant to that mine.
- (d) Despite any other provision, where:
- (i) Aurizon Network gives a Negotiation Cessation Notice under this **clause 4.13**; and
 - (ii) the person to whom it was given wishes to commence a Dispute in respect of the giving of that Negotiation Cessation Notice,
- the person must give a Dispute Notice in accordance with **clause 11.1.1(a)** within ten (10) Business Days after that Negotiation Cessation Notice is given.
- (e) Where Aurizon Network gives a Negotiation Cessation Notice, that Negotiation Cessation Notice has no effect until:
- (i) the expiry of the period under **clause 4.13(d)** without a relevant Dispute Notice being given to Aurizon Network; or

- (ii) where a Dispute Notice is given to Aurizon Network within that period, the Dispute is resolved in favour of Aurizon Network.

Part 5: Access Agreements

5.1 Development of Access Agreement

- (a) The granting of Access will be underpinned by an Access Agreement that will be developed and finalised under **Part 4** of this Undertaking (**Negotiation Process**).
- (b) The parties to the Access Agreement will be Aurizon Network and the Access Holder. The Access Holder need not be the Railway Operator for the relevant Train Services.
- (c) The terms of an Access Agreement must be:
 - (i) for coal carrying services, the Standard Access Agreement; and
 - (ii) for non-coal carrying services, an Access Agreement consistent with the Standard Access Agreement amended to reflect the fact that the Access is for non-coal carrying services.
- (d) Despite **clause 5.1(c)**, the Access Seeker may agree with Aurizon Network during the Negotiation Process to vary the terms of the Standard Access Agreement and any provision of this Undertaking incorporated by reference into the Standard Access Agreement (including **clauses 7.4.1, 7.4.8(a), (b), (c), (d), (e) and (f)** and **7.6**), in which case, any amendments proposed to those terms must be negotiated by both Aurizon Network and the Access Seeker acting reasonably and in good faith.
- (e) Where the terms of an Access Agreement cannot be agreed within the time set out in **clause 4.11.1(d)(iv)**, any dispute will be resolved by (and incorporating amendments agreed by Aurizon Network and the Access Seeker and in respect of which there is no dispute):
 - (i) where Access is required for coal carrying services, the parties completing and entering into the Standard Access Agreement. In this circumstance **Part 11** does not apply;
 - (ii) where Access is required for non-coal carrying services, in accordance with the dispute resolution mechanism in **Part 11**, by the QCA or an expert, as applicable, completing an Access Agreement which is consistent with the Standard Access Agreement, amended to reflect the fact that the Access is for non-coal carrying services; and
 - (iii) where Access is:
 - (A) dependent on an Expansion (whether or not agreed under **Part 8** or determined or agreed to be required in accordance with **clause 07A.5**); or

- (B) is subject to proposed Access Conditions in accordance with **clause 6.13**,
in accordance with the dispute resolution mechanism in **Part 11**, by the QCA or an expert, as applicable, completing or amending (as relevant) the relevant Access Agreement based on the Standard Access Agreement to the extent relevant.
- (f) Aurizon Network must not agree to include in an Access Agreement a term that limits its ability to require the Access Holder to disclose to Aurizon Network all information required by Aurizon Network (acting reasonably) to prepare and publish the ITP.
- (g) Once the Access Seeker notifies Aurizon Network that it is satisfied with the terms and conditions of the Access Agreement provided to it, Aurizon Network must, as soon as reasonably practicable, provide the Access Agreement (or, where appropriate, an amendment to an existing Access Agreement) in final form, which reflects the agreement reached between Aurizon Network and the Access Seeker, to the Access Seeker for execution.
- (h) The parties must execute the final form of the Access Agreement:
- (i) produced by the QCA or an expert in resolving a dispute referred to in **clause 5.1(e)**; or
 - (ii) accepted by the Access Seeker under **clause 5.1(g)**,
as soon as reasonably practicable after resolution of the dispute or Aurizon Network delivers it to the Access Seeker (as applicable).
- (i) Aurizon Network must execute an Access Agreement with an Access Seeker up to two (2) years prior to the commencement of Train Services under the Access Agreement or such longer period as may be agreed.
- (j) Where an Access Seeker is seeking Access Rights that are additional rights to, or a variation of, an existing Access Agreement to which the Access Seeker is a party, nothing in this Undertaking obliges Aurizon Network to agree to terms in respect of those Access Rights that are consistent with that existing Access Agreement.

5.2 Access Charges under Access Agreements

- (a) An Access Holder's Train Service Entitlement may be comprised of various different types of Train Services described by reference to the characteristics set out in Part A, Schedule 2 of the Standard Access Agreement. The Standard Access Agreements refer to each type of Train Service as a "Train Service Type".
- (b) In the circumstances described in **clause 5.2(a)**, the Access Charges may be calculated by reference to each type of Train Service.

5.3 Development of Train Operations Deed

- (a) To use the Access Rights granted under an Access Agreement, the Access Holder must procure a Train Operations Deed is negotiated as part of the Negotiation Process.
- (b) The parties to the Train Operations Deed will be Aurizon Network and the Train Operator for the relevant Train Services.
- (c) The terms of the Train Operations Deed must be the Standard Train Operations Deed.
- (d) Despite **clause 5.3(c)**, the Train Operator may agree to vary the terms of the Train Operations Deed, in which case any amendments proposed to those terms must be negotiated by both Aurizon Network and the Train Operator acting reasonably and in good faith.
- (e) Where the terms of a Train Operations Deed cannot be agreed any dispute will be resolved by (and incorporating amendments agreed by Aurizon Network and Train Operator and in respect of which there is no dispute):
 - (i) where Access is required for coal carrying services, the parties completing and entering into the Standard Train Operations Deed. In this circumstance, **Part 11** does not apply;
 - (ii) where Access is required for non-coal carrying services, in accordance with the dispute resolution mechanism in **Part 11**, by the QCA or an expert, as applicable, completing a Train Operations Deed which is consistent with the Standard Train Operations Deed, amended to reflect the fact that the Access is for non-coal carrying services; and
 - (iii) where Access is:
 - (A) dependent on an Expansion (whether or not agreed under **Part 8** or determined or agreed to be required in accordance with **clause 07A.5**); or
 - (B) is subject to proposed Access Conditions in accordance with **clause 6.13**,in accordance with the dispute resolution mechanism in **Part 11**, by the QCA or an expert, as applicable, completing or amending (as relevant) the relevant Train Operations Deed based on the Standard Train Operations Deed to the extent relevant.
- (f) Once the Train Operator and, if different, the Access Holder, has notified Aurizon Network that it is satisfied with the terms and conditions of the Train Operations Deed provided to it, Aurizon Network will, as soon as reasonably practicable, provide the Train Operations Deed (or, where appropriate, an amendment to an

existing Train Operations Deed) in final form, which reflects the agreement between Aurizon Network and the Train Operator (and, if different, the Access Holder), to the Train Operator for execution.

- (g) The parties must execute the final form of the Train Operations Deed:
 - (i) produced by the QCA or an expert in resolving a Dispute referred to in **clause 5.3(e)**; or
 - (ii) accepted by the Access Seeker under **clause 5.3(f)**,
as soon as reasonably practicable after resolution of the Dispute or Aurizon Network delivers it to the Train Operator (as applicable).
- (h) Aurizon Network must execute a Train Operations Deed with a Train Operator at any time after the related Access Agreement has been entered into but, in any event, prior to the commencement by that Train Operator of relevant Train Services under the related Access Agreement. For clarity, this **clause 5.3(h)** does not restrict the execution of subsequent Train Operations Deeds that relate to different Train Services or the execution of subsequent Train Operations Deeds with different Railway Operators that relate to the same Train Services.

5.4 Rebate under Access Agreements

Despite any provision in an Access Agreement or Access Interface Deed to the contrary, Aurizon Network will not, in respect of any Access Agreement or Access Interface Deed, rely on:

- (a) any exclusion of consequential loss provision;
- (b) any provision which requires a loss to be greater than a specified amount before a claim can be made or which requires liability to be capped at a certain amount;
- (c) any provision which excludes liability for claims in respect of any loss arising in connection with the standard of the Rail Infrastructure or any failure or defect in the Rail Infrastructure, to the extent that the loss arises from:
 - (i) a failure of Aurizon Network to comply with its obligations under this Undertaking, the relevant Access Agreement or the Train Operations Deed; or
 - (ii) Aurizon Network's negligence in performing the obligations in **clause 5.4(c)(i)**; or
- (d) any exclusion of liability for claims in respect of any failure by Aurizon Network to make the Rail Infrastructure available for an Operator to operate a Train Service at the Scheduled Time, to the extent that the failure to make the Rail Infrastructure available was caused by or results from:

- (i) a failure of Aurizon Network to comply with its obligations under this Undertaking, the relevant Access Agreement or Train Operations Deed; or
- (ii) Aurizon Network's negligence in performing the obligations in **clause 5.4(d)(i)**;

in order to avoid the payment of, or reduce any amount of a Rebate which would otherwise be payable under **clause 7A.6**.

Part 6: Pricing principles

6.1 Application of pricing principles

- (a) Aurizon Network will apply the pricing principles set out in this **Part 6** in developing Access Charges and Reference Tariffs.
- (b) To the extent that any of those pricing principles conflict, Aurizon Network will apply the pricing principles in the order of precedence identified below (from highest to lowest):
 - (i) **clause 6.2** to **clause 6.5** (price differentiation and new Reference Tariffs);
 - (ii) **clause 6.6** (pricing limits);
 - (iii) **clause 6.7.1** (Rail Infrastructure utilisation);
 - (iv) **clause 6.8** (revenue adequacy); and
 - (v) all remaining provisions of this **Part 6**.
- (c) In this **Part 6**, where Access Rights have been, or are to be, granted under an Access Agreement, the relevant Access Holder and all of that Access Holder's Train Operators will be treated as a single entity so that a reference to:
 - (i) an Access Seeker is a reference to the Access Seeker and its Train Operators collectively; and
 - (ii) an Access Holder is a reference to the Access Holder and its Train Operators collectively.
- (d) For clarity, all references in this Undertaking to Access Seekers and Access Holders include Related Operators (where applicable).

6.2 Price differentiation

6.2.1 *Limitations on price differentiation*

- (a) Aurizon Network will not differentiate Access Charges between any combination of Access Seekers and Access Holders (including combinations involving only Access Seekers or only Access Holders) except as permitted by this **Part 6**.
- (b) Except as permitted by this **Part 6**, Aurizon Network will not set charges that discriminate in favour of any:
 - (i) Related Operator; or
 - (ii) Related Party,and must ensure that its Access Charges for any Related Operator or Related Party:
 - (iii) comply with this **Part 6**;

- (iv) are equivalent to its Access Charges for other Access Seekers or Access Holders (as applicable) in similar circumstances; and
- (v) do not have the purpose of preventing or hindering an Access Seeker's or Access Holder's Access in a way that would contravene Aurizon Network's obligations under sections 104 or 125 of the Act.

6.2.2 *Default application of Reference Tariff*

Subject to **clause 6.2.3**, where there is an applicable Reference Tariff, the Access Charge formulated by Aurizon Network for an Access Seeker will be calculated in accordance with the Reference Tariff.

6.2.3 *Price differentiation where a Reference Tariff applies*

- (a) Subject to **clause 6.13**, Aurizon Network may seek to commercially negotiate and agree a reasonable Access Charge with an Access Seeker at any time that varies from the applicable Reference Tariff to recognise a difference in cost or risk associated with the provision of Access to a Train Service that has different characteristics to the Reference Train Service. However, the applicable Reference Tariff will apply unless and until any such Access Charge has been approved by the QCA.
- (b) If, after the Commencing Date, Aurizon Network enters into an agreement separate from the Access Agreement for a Customer Specific Branch Line which provides for Aurizon Network to earn revenue that is in addition to the ongoing Access Charge (for example, an upfront contribution or Access Facilitation Charge), Aurizon Network must exclude the cost components separately funded through the additional revenue (for example, the value of any relevant Customer Specific Branch Line to the extent supported by the additional revenue) from the cost base (including the asset base) used to determine:
 - (i) that ongoing Access Charge for Train Services using that Customer Specific Branch Line; and
 - (ii) the applicable Reference Tariff.
- (c) The rtp for a Train Service will be calculated in accordance with the following principles:
 - (i) rtp is deemed to equal one where:
 - (A) the maximum number of proposed Train Services at full utilisation exceeds the maximum number of Reference Train Services at full utilisation; and
 - (B) the scheduled section running times of the proposed Train Service are the same as the nominated section running times for the Reference Train Service; and

- (ii) where **clause 6.2.3(c)(i)** does not apply, the number of reference Train Paths used by the proposed Train Service will be determined as follows:

$$rtp = \max[(A/B), (B/A)]$$

where:

- A is the maximum number of Reference Train Services at full utilisation; and
- B is the maximum number of the proposed Train Services at full utilisation;
- (iii) the maximum number of Train Paths available for a Reference Train Service and for the proposed Train Service will be determined using a readily available simulation package; and
- (iv) for the purpose of **clauses 4.6(c)(v)** and **4.11.2(a)(iv)** (as applicable), Aurizon Network will advise the Access Seeker how it has determined the value of rtp,

unless the QCA approves an alternative methodology, on the request of Aurizon Network, for the purpose of this clause, in which case rtp will be calculated in accordance with that approved alternative methodology.

6.2.4 Price differentiation where no Reference Tariff applies

If there is no applicable Reference Tariff (for example, because the relevant Train Service is a non-coal carrying Train Service), the Access Charge formulated by Aurizon Network for an Access Seeker may vary from the Access Charges for other Access Seekers or Access Holders. However, such variation may only be in respect of other Train Services that provide the same type of transport service (for example, transporting passengers (where the relevant Access Seeker's proposed Train Services transport passengers) or transporting the same commodity (where the relevant Access Seeker's proposed Train Services transport a commodity)) in the same geographical area as that Access Seeker's proposed Train Services, on a unit rate basis to reasonably reflect, over time:

- (a) changes or differences in the cost or risk relevant to Aurizon Network providing Access; or
- (b) Changes in Market Circumstances; or
- (c) limitations on Available Capacity in accordance with **clause 6.7.1(b)**.

6.2.5 Consequences if contravention of Part 6

- (a) If an Access Holder (**Aggrieved Access Holder**) suspects that after entering into an Access Agreement with Aurizon Network, Aurizon Network has subsequently entered into an Access Agreement with another Access Holder for a like Train Service (where a like Train Service is one that transports the same specified commodity in the

same specified geographic area), and the subsequent Access Agreement contains an Access Charge in contravention of this **Part 6**, the Aggrieved Access Holder may notify a Dispute by giving a Dispute Notice under **Part 11**.

- (b) In the event a Dispute is notified under **Part 11** in accordance with **clause 6.2.5(a)**, the QCA may give one or more notices to Aurizon Network under section 150AA of the Act to find out whether Aurizon Network is complying with this Undertaking.
- (c) In respect of any Dispute notified under **clause 6.2.5(a)**:
 - (i) the Dispute must be resolved by the QCA under **clause 11.1.5**, disregarding **clauses 11.1.2 to 11.1.4**;
 - (ii) the QCA must resolve the Dispute by identifying whether it considers that a contravention of this **Part 6** has occurred, based on the information before the QCA at the time and reasonable inferences from that information (including any information sought under **clause 6.2.5(b)**);
 - (iii) if a contravention is identified to have occurred under **clause 6.2.5(c)(ii)**, the QCA may give directions to Aurizon Network to resolve the Dispute, which may include a specific direction that Aurizon Network offer the Aggrieved Access Holder either:
 - (A) an Access Charge calculated on the same basis as the relevant like Train Service; or
 - (B) if the QCA considers appropriate, a particular Access Charge that in the QCA's view neutralises the effect of the contravention; and
 - (iv) on receiving any such specific direction, Aurizon Network must within five (5) days make a legally binding offer to the Aggrieved Access Holder to give effect to that direction.

6.3 Access Charges for new coal carrying Train Services

6.3.1 Determination of Access Charges

- (a) Where an Access Seeker or Access Holder seeks Access Rights for new or additional coal carrying Train Services, this **clause 6.3** (subject to **clause 6.4**) applies to determine the Access Charges payable by the Access Seeker or Access Holder.
- (b) The Access Charges applicable for a new coal carrying Train Service will be calculated under **clause 6.3.1(c)** separately for non-electric Access Charges (tariffs AT₁ to AT₄ collectively) and electric Access Charges (tariff AT₅).
- (c) The Access Charges applicable for a new coal carrying Train Service will be the higher of (on a \$/ntk basis):

- (i) the relevant Reference Tariff (including any Reference Tariff determined in accordance with **clause 6.4**) applied to that Train Service, less the annual maximum allowable revenue (calculated in the same manner as for the relevant Reference Tariff) derived from the Approved PIC (if any); and
 - (ii) the Minimum Revenue Contribution, calculated as the sum of the Incremental Costs of using any Rail Infrastructure specifically for the new coal carrying Train Service and the higher of:
 - (A) any applicable Expansion Costs (as determined in accordance with **clause 6.4**); and
 - (B) as applicable:
 - (1) for non-electric Access Charges, the sum of:
 - the relevant AT₂ component of the relevant Reference Tariff (adjusted for any variation that will be made in accordance with **Schedule F** for that Train Service for a Cross System Train Service); and
 - fifty percentage points (50%) of the AT₃ component of the relevant Reference Tariff (adjusted for any variation that will be made in accordance with **Schedule F** for that Train Service for a Cross System Train Service) for the distance that the Train Service will travel on the mainline of that Coal System; or
 - (2) for electric Access Charges, zero.
- (d) Where an Access Charge is determined in accordance with **clause 6.3.1(c)**:
- (i) the requirements under **clause 6.3.1(c)** must be reapplied to review and reset the Access Charge whenever there is a change to the relevant Reference Tariff or the Approved PIC;
 - (ii) an Access Agreement may include provisions to ensure that the effect of **clause 6.3.1(d)(i)** is reflected in the Access Agreement;
 - (iii) despite **clause 6.3.1(d)(ii)**:
 - (A) the application and reapplication of **clause 6.3.1(c)** is deemed to form part of the Reference

Tariff that is applicable to the relevant Train Service; and

- (B) where the reapplication of **clause 6.3.1(c)** results in a different Access Charge that different Access Charge is deemed to be a change to the relevant Reference Tariff including for the purpose of **clause 6.5.2(a)(i)**.
- (e) Where an Access Seeker has requested Access Rights (other than as a Renewal) that do not require an Expansion and two or more Reference Tariffs are expressed to apply in relation to the Access Rights in the relevant Coal System, then the Reference Tariff used to formulate the relevant Access Charges is that Reference Tariff which is the highest on a \$/ntk basis. For clarity:
 - (i) for a Cross System Train Service, this clause would be applied separately in relation to each relevant Coal System; and
 - (ii) for a Renewal, the relevant Reference Tariff will be the Reference Tariff that applied or would have applied in relation to the Access Seeker's existing Access Agreement.

6.3.2 QCA approval of Private Incremental Costs

- (a) Without limitation and following consultation with Aurizon Network, the QCA may approve the prudent and efficient value of Private Incremental Costs associated with Private Infrastructure, on request from an Access Seeker or Aurizon Network ("**Approved PIC**"), to the extent that the QCA is satisfied that this expenditure is for the prudent and efficient value of the assets that are used to provide the relevant Train Services over Private Infrastructure.
- (b) In determining prudence and efficiency of Private Incremental Costs under **clause 6.3.2(a)**, the QCA may have regard to the following (without limitation and in the QCA's absolute discretion):
 - (i) the scope of works for a capital expenditure project (including whether the requirement for the works is prudent and efficient);
 - (ii) the standard of works for a capital expenditure project (including whether the standard could be expected to deliver the requirements for that capital expenditure project without it being overdesigned or likely to deliver a capital works project which is beyond the requirements of its scope); and
 - (iii) whether the costs of the capital expenditure project are prudent and efficient, having regard to the scope and standard of work undertaken or to be undertaken for the capital expenditure project.

- (c) If the QCA is requested to determine the prudence and efficiency of Private Incremental Costs under **clause 6.3.2(a)**, before the Private Incremental Costs are incurred, the QCA may include as conditions of its approval for any Private Incremental Costs:
 - (i) the assumptions relevant to its approval including:
 - (A) cost to construct;
 - (B) time for completion of; and
 - (C) estimated capacity to be delivered by,
 - the Private Incremental Costs;
 - (ii) other matters considered by the QCA to be material to its approval; and
 - (iii) the period of time in which the approval has effect (and if the project is not completed within the nominated time, the QCA may decide the approval ceases to have effect).
- (d) If the QCA is requested to determine the prudence and efficiency of Private Incremental Costs under **clause 6.3.2(a)** after the Private Incremental Costs are incurred:
 - (i) the Access Seeker may request the QCA to take into account only information and analysis that the Access Seeker could reasonably be expected to have considered or undertaken at the time that the relevant Private Incremental Costs were incurred; and
 - (ii) the QCA will consider this request as part of its determination.
- (e) For clarity:
 - (i) when considering the Private Incremental Costs, the QCA may refuse to approve an Access Seeker's proposal and instead approve a lesser amount as the Approved PIC; and
 - (ii) the Approved PIC is zero unless and until the QCA approves the relevant Private Incremental Costs under this **clause 6.3.2**.
- (f) The value of the Approved PIC is to be maintained in the same way as the Regulatory Asset Base is maintained in accordance with **Schedule E**.
- (g) When determining the amount of the Approved PIC, the QCA may make such adjustments to the Private Incremental Costs as it considers appropriate to be satisfied under **clause 6.3.2(a)**.

6.4 Access Charges for coal carrying Train Services that require an Expansion

6.4.1 *Expansion pricing principles*

- (a) Where an Access Seeker or Access Holder seeks Access Rights for coal carrying Train Services that require an Expansion (**Expanding User**), this **clause 6.4** applies to identify the appropriate Access Charges payable by the Expanding User.
- (b) This **clause 6.4** is intended to be read in conjunction with **Part 8** of this Undertaking and is subject to **clause 6.3** (use of Private Infrastructure).
- (c) The methodology set out in this **clause 6.4** will apply on an individual Coal System basis.
- (d) The remainder of this **clause 6.4** articulates the following principles (applying the definitions set out below), known as the “**Expansion Pricing Principles**”:
 - (i) Expanding Users should generally pay an Access Charge that reflects at least the full incremental costs (capital and operating) of providing additional Capacity;
 - (ii) subject to **clause 6.4.1(d)(iv)**, Non-Expanding Users should not experience a material increase in Reference Tariffs due to an Expansion triggered by Expanding Users;
 - (iii) if Expanding Users face a higher cost than Non-Expanding Users, a zero contribution to Aurizon Network’s Common Costs from Expanding Users is generally acceptable; and
 - (iv) an allocation of the Expansion Costs to Non-Expanding Users may be appropriate where an Expansion has clear benefits to those Non-Expanding Users.
- (e) For the purposes of this **clause 6.4**:
 - (i) “**Consensus**” means all Expansion Stakeholders have notified Aurizon Network that they consider that a particular draft Pricing Proposal from Aurizon Network for an Expansion represents an acceptable distribution of Expansion Costs and apportionment of Volume Risk that is consistent with the Expansion Pricing Principles;
 - (ii) “Consensus Expansion” means an Expansion for which Consensus has been achieved by Aurizon Network as anticipated in **clause 6.4.2**;
 - (iii) “**Customised Expansion**” means an Expansion that is not a Consensus Expansion or an Endorsed Expansion where the indicative Reference Tariff for the Pricing Proposal is a bespoke solution determined by applying **clause 6.4.3(d)** and the Expansion Pricing Principles in **clause 6.4.1**,

taking into account the extent of any agreement between Expansion Stakeholders;

- (iv) “**Endorsed Expansion**” means an Expansion that is not a Consensus Expansion where the indicative Reference Tariff for the Pricing Proposal is a formulaic solution determined by applying **clause 6.4.5**;
- (v) “Expansion Cost” has the meaning given by **clause 6.4.4(a)(ii)**;
- (vi) “**Expansion Stakeholders**” means all Expanding Users and all Non-Expanding Users for an Expansion;
- (vii) “**Non-Expanding Users**” means Access Seekers and Access Holders within a Coal System that are not Expanding Users for an Expansion to that Coal System;
- (viii) “**Substitutable Train Service Entitlements**” or “**Substitutable TSEs**” means that an Access Holder has one or more existing Train Service Entitlements in a Coal System that can be used as an alternative to the one or more Train Service Entitlements with the same origin created by the Expansion.

6.4.2 Consensus Expansion

- (a) Before Aurizon Network submits a Pricing Proposal to the QCA under **clause 6.4.4**, Aurizon Network must approach Expansion Stakeholders in good faith to seek to facilitate a Consensus on a Pricing Proposal. Aurizon Network must provide reasonable information as requested by each Expansion Stakeholder to facilitate a Consensus. The QCA may participate in any consultation processes undertaken by Aurizon Network with Expansion Stakeholders at the QCA’s absolute discretion.
- (b) Aurizon Network must keep the QCA informed of progress in facilitating a Consensus by providing updates to the QCA on any significant developments or otherwise as requested by the QCA.
- (c) If a Consensus has not been reached by the date for the completion of the Feasibility Study, or Aurizon Network or any Expansion Stakeholder can otherwise provide evidence to the QCA that a Consensus will not be achieved by that date, or any further time period has lapsed under **clause 6.4.2(d)**, then:
 - (i) Aurizon Network (or the Expansion Stakeholder, if applicable, copying Aurizon Network) will consult with the QCA whether further time should be allocated to facilitate a Consensus; and
 - (ii) unless the QCA responds to Aurizon Network within ten (10) Business Days requesting further time to be allocated, the Expansion must be treated by Aurizon Network as

either a Customised Expansion or Endorsed Expansion (as applicable).

- (d) If the QCA requires an extension of time under **clause 6.4.2(c)(ii)**, then Aurizon Network must continue to seek a Consensus until that time has lapsed, at which point Aurizon Network will consult with the QCA again under **clause 6.4.2(c)**. For clarity, the QCA may require multiple extensions of time to occur.

6.4.3 Other Expansions

- (a) Unless otherwise agreed by the QCA, an Expansion with no Substitutable TSEs and that is not a Consensus Expansion will be treated as an Endorsed Expansion.
- (b) An Expansion that is not a Consensus Expansion or an Endorsed Expansion will be treated as a Customised Expansion.
- (c) For an Endorsed Expansion, the indicative Reference Tariff for the Pricing Proposal that is submitted by Aurizon Network under **clause 6.4.4** will have multi-part pricing and price discrimination to aid efficiency in which:
 - (i) Expanding Users will pay the Expansion Tariff that is calculated in accordance with **clause 6.4.5**; and
 - (ii) Non-Expanding Users will pay the System Reference Tariff on a basis consistent with the cost allocation principles approved by the QCA under **clause 6.4.4(e)(i)** and adjusted in accordance with **clause 6.4.5(f)**.
- (d) For a Customised Expansion, the indicative Reference Tariff must give effect to the Expansion Pricing Principles set out in **clause 6.4.1**, taking into account the extent of any agreement between Expansion Stakeholders, and the factors set out in section 138(2) of the Act.

6.4.4 Pricing Proposal

- (a) If an Expanding User seeks Access Rights for coal carrying Train Services that require an Expansion, Aurizon Network will, as part of its Feasibility Study for that Expansion, submit to the QCA a proposal with the following elements:
 - (i) a determination whether the Expansion involves any Substitutable TSEs;
 - (ii) a proposed allocation of costs arising from the Expansion (including a detailed breakdown of the estimated capital, maintenance and operating costs for the Expansion) (**Expansion Costs**) between the Expansion Stakeholders (including on a Coal System basis if the Expansion relates to more than one Coal System);

- (iii) any proposed allocation of future renewal costs for the relevant Coal System between Expansion Stakeholders;
- (iv) a proposed apportionment of volume risk arising from the Expansion (e.g. arising from differences between forecast and actual railings) (**Volume Risk**) between the Expansion Stakeholders (including on a Coal System basis if the Expansion relates to more than one Coal System) if applicable;
- (v) all calculations made in applying this **clause 6.4.4**;
- (vi) if the Expansion is an Endorsed Expansion, a determination as to which of the following clauses will apply:
 - (A) **clause 6.4.5(c)** – the Coal System has no existing Expansion Tariff;
 - (B) **clause 6.4.5(e)(ii)** – the Coal System has an Expansion Tariff, but no Socialisation will occur;
 - (C) **clause 6.4.5(e)(vi)** – the Coal System has one or more existing Expansion Tariffs and Socialisation will occur to the extent determined under **clause 6.4.5(e)**;
- (vii) if the Expansion is not a Consensus Expansion, an identification of the extent to which consultation by Aurizon Network with Expansion Stakeholders has occurred;
- (viii) if the Expansion is a Consensus Expansion, all relevant details of the Consensus and copies of all correspondence with Expansion Stakeholders confirming the Consensus and evidencing the Consensus and terms of the Consensus,

and the resulting indicative Reference Tariffs that are proposed by Aurizon Network for the Expansion (**Pricing Proposal**).

- (b) Aurizon Network must provide to the QCA:
 - (i) information explaining the manner in which the Pricing Proposal is consistent with the Expansion Pricing Principles in **clause 6.4.1** and the factors set out in section 138(2) of the Act (including the conditions for any Socialisation);
 - (ii) such other supporting information for the QCA's consideration to justify or explain Aurizon Network's approach; and
 - (iii) such further information as is requested by the QCA to enable the QCA to consider the Pricing Proposal.

- (c) The QCA must:
 - (i) publish the Pricing Proposal;
 - (ii) invite persons (including all Expansion Stakeholders) to make submissions on the Pricing Proposal within a reasonable time period specified by the QCA; and
 - (iii) provide Aurizon Network and Expansion Stakeholders with a draft decision and a reasonable opportunity to respond to that draft decision.
- (d) The parties agree that any Pricing Proposal that is submitted to the QCA under this Undertaking should be made in the form of an application for a ruling under Division 7A of Part 5 of the Act, unless the QCA requests otherwise. If an application is made for a ruling under Division 7A of Part 5 of the Act, **clauses 6.4.4(e) to 6.4.4(h)** are subject to the application of Division 7A of Part 5 of the Act.
- (e) The QCA may:
 - (i) approve the Pricing Proposal; or
 - (ii) refuse to approve the Pricing Proposal, with reasons provided to Aurizon Network.
- (f) If the QCA approves the Pricing Proposal, the QCA may state in its ruling that it will no longer apply if there is a material change in circumstances. In such circumstances, the QCA may invite Aurizon Network to submit an updated Pricing Proposal (and application under Division 7A of Part 5 of the Act, if applicable).
- (g) If the QCA refuses to approve a Pricing Proposal or invites Aurizon Network to submit an updated Pricing Proposal, Aurizon Network will, if applicable, submit a replacement Pricing Proposal to the QCA (and application under Division 7A of Part 5 of the Act, if applicable).
- (h) Aurizon Network must notify the QCA immediately upon becoming aware that a change in circumstances has arisen in relation to the Pricing Proposal, including any calculations or information used in the course of preparing the Pricing Proposal.

6.4.5 Calculation of indicative Reference Tariff for Endorsed Expansions

- (a) This **clause 6.4.5** applies only to an Endorsed Expansion.
- (b) Socialisation of an Endorsed Expansion involves the aggregation of the Expansion Costs of a new Expansion (**New Expansion**) with the costs associated with one or more existing Expansion Tariffs for the same Coal System in order to identify common Expansion Tariffs. For an Endorsed Expansion, Socialisation is assessed for tariffs AT₁ to AT₄ (collectively) independently from Socialisation for tariff AT₅. The iterative methodology set out in the remainder of this **clause 6.4.5** must be applied to both sets of tariffs independently.

- (c) If a Coal System has no existing Expansion Tariff, an Expansion Tariff for the Expansion, applicable to the Expanding User, will be calculated in accordance with **clause 6.4.6(a)**, subject to adjustment under **clause 6.4.5(f)**.
- (d) If a Coal System has one or more existing Expansion Tariffs, an Expansion Tariff for the Expansion will be calculated in accordance with the iterative methodology for socialising Expansions set out in **clause 6.4.5(e)**. Aurizon Network must apply this methodology and include its associated calculations in the Pricing Proposal under **clause 6.4.4(a)** based on:
 - (i) the Expansion Costs after adjustment in accordance with the proposed cost allocation principles;
 - (ii) forecast volumes arising as a result of the Expansion as set out in the Feasibility Study; and
 - (iii) the analysis being undertaken on a forward-looking basis, looking at the effect:
 - (A) at the end of each Quarter after the earliest contracted commencement of Access by Access Holders whose Access Agreements were conditional on the relevant Expansion (**Initial Access Holders**); until and including
 - (B) the peak point for contracted Access by the Initial Access Holders.
- (e) Iterative methodology for socialising Expansions:
 - (i) **Step One:** Aurizon Network must calculate:
 - (A) which of the existing Expansion Tariffs applicable to the relevant Coal System is the highest on a \$/ntk basis after being adjusted in a manner consistent with the proposed cost allocation principles based on the Expansion's Projected Cost (**Highest Expansion Tariff**); and
 - (B) whether the Highest Expansion Tariff would, on a \$/ntk basis, decrease if the Highest Expansion Tariff and the Expansion Costs of the New Expansion were socialised (**Tariff Decrease**).
 - (ii) **Step Two:** If under Step One, a Tariff Decrease would not occur, then the Highest Expansion Tariff will not be socialised with the Expansion Costs of the New Expansion unless otherwise agreed by the QCA. A new Expansion Tariff, applicable to the New Expansion, will be established in accordance with **clause 6.4.6(a)**.
 - (iii) **Step Three:** If under Step One, a Tariff Decrease would occur, then the Highest Expansion Tariff will be socialised

with the Expansion Costs of the New Expansion to determine a common Expansion Tariff (**Socialised Tariff**).

- (iv) **Step Four:** Aurizon Network must calculate whether the remaining next Highest Expansion Tariff for the relevant Coal System would, on a \$/ntk basis, decrease if that next Highest Expansion Tariff and the Socialised Tariff as referred to in Step Three were socialised (also, a **Tariff Decrease**).
 - (v) **Step Five:** Aurizon Network will repeat Steps Three to Five until either there is no further Tariff Decrease or all Expansion Tariffs have been socialised. Where Socialisation occurs in a previous iteration of Steps Three to Five, references to Expansion Costs of the New Expansion in Step Three will be taken to be references to the costs associated with the Socialised Tariff from the last iteration.
 - (vi) **Step Six:** Once the iteration in Steps Three to Five has been completed, the common Expansion Tariff for the New Expansion and the other socialised Expansions will be the Socialised Tariff from the last iteration, subject to adjustment under **clause 6.4.5(f)**.
- (f) If, following the application of **clauses 6.4.5(c) or 6.4.5(e)**, the new or varied Expansion Tariff is lower than the System Reference Tariff for the Coal System on a \$/ntk basis, Aurizon Network must include a positive contribution to its Common Costs in the Expansion Tariff that has the effect of increasing the Expansion Tariff and reducing the System Reference Tariff so that these Reference Tariffs are equivalent on a \$/ntk basis. The contribution to Aurizon Network's Common Costs will be calculated based on contracted volumes. The contribution to Aurizon Network's Common Cost will be assessed for Tariffs AT₁ to AT₄ (collectively) independently from Tariff AT₅.

6.4.6 Reference Tariffs

- (a) Every Expansion Tariff must have a separate:
 - (i) relevant Allowable Revenue (adjusted to recognise all revenue that Aurizon Network receives from all sources that enables it recover the costs of the Expansion); and
 - (ii) Gtk Forecast based on 100% contracted volumes,that can be used to calculate that Expansion Tariff under **Schedule F**. For clarity, an Expansion Tariff will be calculated based on contracted volumes and, when a Take or Pay applies to the Expansion, it will be calculated in accordance with **clause 3.3(n) of Schedule F**.

- (b) If two (2) or more Expansion Tariffs continue to exist for any Coal System, Aurizon Network must undertake a review in consultation with the QCA at least once every twelve (12) Months, whether Socialisation of any of those Expansion Tariffs should occur.
- (c) An Expansion Tariff will cease at the time specified in the Pricing Proposal approved by the QCA at **clause 6.4.4(f)** or where the value of the Expansion Cost in the Regulatory Asset Base is equal to 0.
- (d) The indicative Reference Tariff identified in the Pricing Proposal under **clauses 6.4.4 to 6.4.6** should be proposed to apply instead of the System Reference Tariff for the Coal System.

6.4.7 Formalisation of Pricing Proposal

- (a) For Aurizon Network to formalise the indicative Reference Tariff determined under **clause 6.4.4**, it should prepare and submit to the QCA a draft amending access undertaking to vary this Undertaking consistent with, and to give effect to, any Pricing Proposal that has been approved by the QCA under **clause 6.4.4**.
- (b) Aurizon Network acknowledges that in the absence of a draft amending access undertaking approved by the QCA under Part 5 of the Act:
 - (i) the Pricing Proposal pursuant to **clause 6.4.4** may be the subject of a dispute notified under section 112 of the Act; and
 - (ii) the QCA may give a direction under section 139 of the Act, if the QCA considers it appropriate to do so.

6.4.8 Allocation of Asset Replacement and Renewal Expenditure

- (a) Subject to **clause 6.4.6(a)**, all Asset Replacement and Renewal Expenditure in respect of capital expenditure projects relating to a Coal System must only be included in the capital costs relevant to the calculation of the System Reference Tariff.
- (b) To the extent that Asset Replacement and Renewal Expenditure is necessary for an Expansion to which an Expansion Tariff applies or will apply, then that Asset Replacement and Renewal Expenditure will be treated as part of the cost of that Expansion subject to any applicable cost allocation proposal accepted by the QCA under **clause 6.4.4**.

6.4.9 Indicative Access Charge

- (a) Where **clause 6.4** applies in respect of an Expansion and the applicable Reference Tariff has not yet been determined, this does not affect Aurizon Network's obligations to negotiate Access and enter into an Access Agreement provided that Aurizon Network may enter into an Access Agreement with the relevant Access Seeker on the basis of an indicative Access Charge (taking into account any applicable Pricing Proposal accepted by the QCA under

clause 6.4.4) subject to the Access Agreement including provisions which provide that after the applicable Reference Tariff is determined:

- (i) the Access Agreement will be amended to include an Access Charge based on that Reference Tariff; and
- (ii) the Access Seeker and Aurizon Network will account to each other for any under or over recovery of Access Charges during the period when the indicative Access Charge was applied.

6.4.10 *Interaction with Access Charges for new or additional coal carrying Train Services that involve the use of Private Infrastructure*

Where a new or additional coal carrying Train Service involves the use of Private Infrastructure, **clause 6.4** and **clause 6.3.1(c)** must be applied concurrently for the purposes of setting an Access Charge.

6.5 Process for acceptance of new Reference Tariff

6.5.1A *Application*

This **clause 6.5** does not apply to the reset of the Reference Tariffs in accordance with **Part 6A**.

6.5.1 *Process*

- (a) Where Aurizon Network is negotiating Access Charges for Access Rights and a new Reference Tariff is to be applied under **clause 6.4** in respect of those Access Charges, Aurizon Network will submit a proposed new Reference Tariff to the QCA. The QCA will:
 - (i) publish the proposed Reference Tariff;
 - (ii) invite persons to make submissions on the proposed Reference Tariff to the QCA within a reasonable period of time specified by the QCA; and
 - (iii) consider any submission it receives within that period of time.
- (b) The QCA may approve a proposed Reference Tariff for a new Reference Train Service only if the QCA:
 - (i) is satisfied that the proposed Reference Tariff is consistent with this Undertaking;
 - (ii) considers it appropriate to do so having regard to the factors listed in section 138(2) of the Act; and
 - (iii) for a resubmitted proposed Reference Tariff, is satisfied that Aurizon Network has in all material respects addressed the matters referred to in the relevant notice by the QCA under **clause 6.5.1(e)**.
- (c) If the QCA approves the proposed Reference Tariff:

- (i) it will apply from the earlier of:
 - (A) the date of the QCA's decision; and
 - (B) if Aurizon Network and the Access Seeker have entered into an Access Agreement under **clause 6.4.9**, the date of that Access Agreement,
 - except where the QCA specifies a later date in its decision, in which case the proposed Reference Tariff will apply from that date;
 - (ii) the QCA will give Aurizon Network a notice stating the reasons for its decision at the time of publishing its decision; and
 - (iii) Aurizon Network must:
 - (A) publish a new version of **Schedule F** which includes the new Reference Tariff; and
 - (B) advise Access Holders and Access Seekers, in respect of the Train Services to which the new Reference Tariff applies, that the new Reference Tariff has been approved.
- (d) If the QCA is considering refusing to approve the proposed Reference Tariff:
- (i) it must give Aurizon Network a draft of its decision (including a statement of both its reasons and the way in which it considers the proposed Reference Tariff should be amended);
 - (ii) Aurizon Network may, within twenty (20) Business Days after being given that draft decision (or such longer period as agreed by the QCA), revise the proposed Reference Tariff and/or provide additional information supporting its view that the proposed Reference Tariff should be approved; and
 - (iii) the QCA must consider that revision and/or additional information when deciding whether to approve or refuse to approve the proposed Reference Tariff.
- (e) If the QCA refuses to approve the proposed Reference Tariff, the QCA must give Aurizon Network a notice of the QCA's decision (including a statement of both its reasons and the way in which it considers the proposed Reference Tariff should be amended).
- (f) If the QCA refuses to approve the proposed Reference Tariff, Aurizon Network may resubmit the proposed Reference Tariff with amendments and **clauses 6.5.1(a) to (e)** apply to that resubmitted Reference Tariff.
- (g) For the purposes of this **clause 6.5.1**:

- (i) a proposed Reference Tariff submitted by Aurizon Network must include a new or reviewed Allowable Revenue and GtK Forecast to the extent applicable to that proposed Reference Tariff; and
- (ii) the QCA in approving a proposed Reference Tariff must also approve the new or reviewed Allowable Revenue and GtK Forecast.

6.5.2 Access Charge review provisions

- (a) Without limitation to **clause 6.4.9**, Aurizon Network or an Access Seeker may seek to agree review provisions in an Access Agreement that is being negotiated to enable the Access Charge to be adjusted from time to time in order for those Access Charges to be consistent with changes in:
 - (i) (if a Reference Tariff applies to the Train Service) the applicable Reference Tariff (including any matters under **Schedule F**); and
 - (ii) (if no Reference Tariff applies to the Train Service) the Access Charges agreed with other Access Seekers in respect of Train Services transporting the same commodity within the same geographical area as that Access Seeker's proposed Train Service.
- (b) A Standard Access Agreement must contain review provisions in compliance with this **clause 6.5.2**.

6.6 Pricing limits

6.6.1A Application

This **clause 6.6** does not apply to the reset of the Reference Tariffs in accordance with **Part 6A**.

6.6.1 Application of pricing limits

- (a) Aurizon Network will, in setting the Access Charges for an Access Seeker's proposed Train Services, establish and observe upper and lower limits for the Access Charge(s):
 - (i) for individual Train Services; and
 - (ii) for combinations of Train Services comprised of the proposed Train Services and other Train Services to the extent that they use the same Rail Infrastructure as that which would be used by the proposed Train Services,
at levels:
 - (iii) which ensure there is no Cross Subsidy between individual Train Services or combinations of Train Services (as applicable); and
 - (iv) determined in accordance with **clause 6.6.2**.

- (b) Subject to the approval of the QCA, Aurizon Network may:
- (i) establish a new Reference Tariff; or
 - (ii) vary an existing Reference Tariff in a way,

that is inconsistent with **clause 6.6.2(a)(ii)**, for the primary purpose of promoting efficient investment by either Aurizon Network or another person in the relevant Supply Chain.

6.6.2 Setting price limits

- (a) In setting the Access Charges for an Access Seeker’s proposed Train Services, Aurizon Network will do so such that, over the Evaluation Period, the Expected Access Revenue for any one of those Train Services and any combination of Train Services comprised of the proposed Train Services and other Train Services to the extent that they use the same Rail Infrastructure as that which would be used by the proposed Train Services is:
- (i) no less than the level that will recover the expected Incremental Cost of providing Access for that Train Service or that combination of Train Services (as applicable); and
 - (ii) no more than the level that will recover the expected Stand Alone Cost of providing Access for that Train Service or that combination of Train Services (as applicable).

6.6.3 Application of Maximum Allowable Revenue

- (a) Without limitation to **clause 6.6.2(a)**, where it is necessary to calculate the price limit referred to in **clause 6.6.2(a)(ii)** for the purposes of setting or reviewing a Reference Tariff, the Stand Alone Cost for the Evaluation Period for the Train Services to which the Reference Tariff relates will be the Maximum Allowable Revenue.
- (b) The Maximum Allowable Revenue means the aggregate of the maximum amount of Expected Access Revenue attributable to a section of Rail Infrastructure for the relevant Train Services using that section of Rail Infrastructure over the Evaluation Period.
- (c) The Maximum Allowable Revenue will be measured such that the net present value of the cashflows associated with providing Access for the relevant Train Services over the Evaluation Period is zero. This measurement can be expressed as:

$$0 = -AV_0 + \sum_{t=1}^n \frac{(MAR_t - C_t - M_t - T_t)}{(1+ROA)^t} + \frac{AV_n}{(1+ROA)^n}$$

where:

AV_0 is the value of assets reasonably expected to be required for the Stand Alone provision of Access for the Train Services, assessed in accordance

with **clause 6.6.3(e)**, at the commencement of the Evaluation Period;

n is the number of years in the Evaluation Period;

t is each year within the Evaluation Period from 1 to n ;

MAR_t is the Maximum Allowable Revenue for the Train Services expressed as revenue that may be earned in each year of the Evaluation Period;

C_t is the capital expenditure for assets reasonably expected to be required for the Stand Alone provision of Access for the Train Services in each year of the Evaluation Period;

M_t is the Efficient Cost, including operating and maintenance costs, business and corporate overheads and QCA Levy, reasonably expected to be incurred for the Stand Alone provision of Access for the Train Services in each year of the Evaluation Period;

ROA is the relevant rate of return commensurate with the commercial and regulatory risks involved in nominal post tax terms (with the cost of debt expressed on a before tax basis), as agreed by Aurizon Network and the QCA or, failing such agreement, as determined by the QCA;

T is the tax expense assessed through the application of the statutory tax rate for corporations to the taxable income reasonably expected to be earned through the Stand Alone provision of Access for the Train Services in each year of the Evaluation Period, where such tax expense is reduced in each year by the application of the Gamma factor, reflecting the market value of dividend imputation, as agreed by Aurizon Network and the QCA or, failing such agreement, as determined by the QCA; and

AV_n is the value of assets reasonably expected to be required for the Stand Alone provision of Access for the Train Services, assessed in accordance with **clause 6.6.3(e)**, at the end of the Evaluation Period.

- (d) For the purpose of determining the variables under **clause 6.6.3(c)**, the assumed traffic task resulting from the Train Services over the Evaluation Period is the forecast, as reasonably determined by Aurizon Network, for the traffic task resulting from the Train Services

over the Evaluation Period (including making allowance for any changes in traffic task that are expected to result from the commencement of projects that impact significantly on the traffic task).

- (e) The value of assets used in **clause 6.6.3(c)** will be determined by reference to:
 - (i) the Regulatory Asset Base, as maintained in accordance with **Schedule E**; or
 - (ii) if a value cannot be determined under **clause 6.6.3(e)(i)**, the Depreciated Optimised Replacement Cost methodology.

6.7 Pricing objectives

6.7.1 Rail Infrastructure utilisation

- (a) Aurizon Network may establish different Access Charges for non-coal carrying Train Services serving different markets or commodities to maximise the commercially viable use of Capacity while meeting, in aggregate, the Common Costs.
- (b) Subject to **clause 6.7.1(c)**, if Aurizon Network can evidence to the QCA that:
 - (i) the Available Capacity is insufficient to satisfy the requests for Access Rights of all current and likely Access Seekers; and
 - (ii) an Expansion to provide additional Capacity is not commercially feasible in the circumstances,then:
 - (iii) Aurizon Network may determine the highest Access Charge for a Train Service that it is likely to achieve from the current or likely Access Seekers based on the characteristics of the relevant Reference Train Service for the applicable Coal System (including the terms of the relevant Standard Access Agreement) (**Maximum Access Charge**);
 - (iv) the Maximum Access Charge may be quoted to all Access Seekers in respect of the Available Capacity irrespective of:
 - (A) any Access Seeker's ability to contribute to the Common Costs; or
 - (B) the Access Charges payable in existing Access Agreements for similar Train Services; and

- (v) if Aurizon Network:
 - (A) has received Mutually Exclusive Access Applications;
 - (B) chooses to allocate Available Capacity to one of those Access Seekers for an Access Charge less than the Maximum Access Charge; and
 - (C) another of those Access Seekers is willing to pay an Access Charge equal to the Maximum Access Charge,

then, when determining the Maximum Allowable Revenue in accordance with **clause 6.6.3** for Train Services using that constrained section of Rail Infrastructure, the Access Charge for the Access Seeker will be assumed to be the Maximum Access Charge. For the purpose of **clause 6.7.1(b)(iv)(B)**, Aurizon Network does not make a choice to allocate Available Capacity in a particular way where Aurizon Network's allocation is necessary for compliance with any Law (including any Passenger Priority Obligation or Preserved Train Path Obligation).

- (c) **Clause 6.7.1(b)** does not apply in respect of setting Access Charges in relation to Train Services for which a Reference Tariff applies. For clarity, as Reference Tariffs are intended to apply to all coal carrying Train Services, **clause 6.7.1(b)** will not apply in respect of coal carrying Train Services.

6.8 Revenue adequacy

- (a) This **clause 6.8** does not apply to the reset of the Reference Tariffs in accordance with **clause 6A**.
- (b) Aurizon Network is entitled to earn revenue from the provision of Access that is at least enough to:
 - (i) meet the Efficient Costs of providing Access; and
 - (ii) provide a rate of return on the value of assets commensurate with the regulatory and commercial risks involved.

6.9 Reference Tariffs

6.9.1 *Application of Reference Tariffs*

- (a) A Reference Tariff is one means by which Aurizon Network provides Access Seekers with information about the matters listed in sections 101(2)(a) to (c) of the Act, but is not intended to fully discharge Aurizon Network's obligations under those sections.
- (b) Unless otherwise approved by the QCA or unless otherwise required by the QCA under the Act, Aurizon Network must calculate the

Access Charges for all coal carrying Train Services to which a Reference Tariff applies on a basis that comprises all of the following elements:

- (i) an incremental maintenance component that is levied on a gtk basis – referred to as AT₁;
- (ii) an incremental capacity component that is levied on a Train Path basis – referred to as AT₂;
- (iii) a component that is levied on a ntk basis – referred to as AT₃;
- (iv) a component that is levied on a nt basis – referred to as AT₄;
- (v) an electric access tariff that is levied on an egtk basis (if appropriate) – referred to as AT₅;
- (vi) an electric energy charge, and Variable Connection Charge that is levied on an egtk basis (if appropriate) – referred to as EC;
- (vii) the QCA Levy levied on a nt basis; and
- (viii) the IE Fee levied on a nt basis,

and including any other amount that may be included in an Access Charge in accordance with this Undertaking.

6.9.2 Review of Reference Tariffs

Subject to **Part 6A, Schedule F** will specify the period for which a Reference Tariff is effective and how the Reference Tariff may be reviewed during that period.

6.9.3 Publishing updated ~~Schedule F~~ *Schedule F*

Where any matters in **clauses 7 to 12 of Schedule F** are amended or varied from time to time, including where the QCA approves any revisions or other adjustments to Allowable Revenues, Gtk Forecasts or Reference Tariffs in accordance with this Undertaking, Aurizon Network must publish a new version of those **clauses 7 to 12 of Schedule F** which includes that amendment, variation, revision or adjustment.

6.10 Structure of non-Reference Tariff Access Charges

Where there is no Reference Tariff applicable for a Train Service (for example, a passenger or non-coal freight Train Service), the structure of Access Charges for that Train Service will be negotiated with the relevant Access Seeker depending on their particular requirements and, without limiting Aurizon Network's and the relevant Access Seeker's discretion to agree a structure, may include any one or more of the following:

- (a) an initial upfront component as a condition to being granted Access Rights;

- (b) an ongoing periodic fixed component independent of the level of usage of the Rail Infrastructure; and
- (c) one or more ongoing variable components based on usage of the Rail Infrastructure.

6.11 QCA Levy

Access Charges for any Train Service may include a QCA Levy component to be collected for the QCA by Aurizon Network. This component of Access Charges will, where applicable, be determined from year to year based on the QCA Levy levied by the QCA to Aurizon Network and allocated amongst Train Services in a manner approved by the QCA.

6.12 Regulatory Asset Base

Aurizon Network will maintain the Regulatory Asset Base in accordance with **Schedule E** and subject to **clauses 7A.5(i)(iii)** and **8.2.1(b)(ii)(F)**.

6.13 Access Conditions

This **clause 6.13** only applies to coal carrying Train Services.

6.13.1 *Negotiation of Access Conditions*

Aurizon Network and an Access Seeker, each acting reasonably, may agree to Access Conditions under this **clause 6.13**, before the Access Seeker is granted Access Rights, to the extent that this is reasonably required in order to mitigate Aurizon Network's or the Access Seeker's exposure to any additional costs or risks associated with providing Access for the Access Seeker's proposed Train Service and which are not, or would not, be included in the calculation of the Reference Tariff based on the Approved WACC.

6.13.2 *Approval of Access Conditions*

- (a) If Aurizon Network intends to commence negotiating Access Conditions (or continue doing so where negotiations for the provision of Access were already underway at the Approval Date) it must issue to all relevant Access Seekers, Customers and the QCA a report which details:
 - (i) the Access Conditions that Aurizon Network is seeking from any Access Seeker;
 - (ii) quantification of the additional costs or risks Aurizon Network is exposed to (the **Additional Risks**), which it is seeking to mitigate through the Access Conditions;
 - (iii) why Aurizon Network's exposure to the Additional Risks would not be:
 - (A) reasonably mitigated by an Access Agreement which permits Aurizon Network to charge Access Charge(s) calculated in accordance with a Reference Tariff based on the Approved WACC and 100% Take or Pay commitments; or

- (B) more efficiently mitigated through insurance or other financial instruments;
 - (iv) to the extent that the Access Conditions being sought indicate Access Charges or any other monetary consideration (whether under an Access Agreement or other agreement) being payable, evidence that:
 - (A) there are risks not mitigated by the other Access Conditions being sought, and the adjustments are reflective of the possible outcomes and probabilities of the outcomes as a consequence of such risks; and/or
 - (B) there is either a materially different Risk Free Rate or debt margin, the cost of funding in anyway or that, as a result of the Aurizon Network funding a capital expenditure project, Aurizon Network would have a materially different gearing ratio or credit rating, from that which was assessed at the time the Approved WACC was determined by the QCA; and
 - (v) confirmation that Aurizon Network considers the proposed Access Conditions would not contravene a provision of this Undertaking or the Act.
- (b) If the QCA has reason to believe that Aurizon Network has commenced negotiating Access Conditions in respect of the provision of Access prior to providing a report as required by **clause 6.13.2(a)**, it may require Aurizon Network to:
 - (i) produce a report in accordance with **clause 6.13.2(a)** within ten (10) Business Days; and
 - (ii) cease negotiating Access Conditions until such a report has been provided.
- (c) Aurizon Network and the Access Seekers may, after Aurizon Network has provided the report required by **clause 6.13.2(a)**, negotiate for sixty (60) days on the terms of those Access Conditions, provided that:
 - (i) either Aurizon Network or any Access Seeker may apply to the QCA for an extension to the negotiation period (subject to the period not being extended to more than one hundred and twenty (120) days unless a majority of Access Seekers request such an extension); and
 - (ii) an Access Seeker may refer the proposed Access Conditions to the QCA for a determination at any time during the negotiation period (although the QCA may decline to make a determination until the negotiation period has expired where it considers a prior referral is vexatious

or the referring party has not engaged in the negotiation of Access Conditions in good faith).

- (d) Following receipt of the report required by **clause 6.13.2(a)**, the QCA will invite and consider comments from relevant stakeholders regarding the proposed Access Conditions.
- (e) To the extent that all Access Seekers agree to the Access Conditions sought by Aurizon Network during the period in **clause 6.13.2(c)**, the QCA will approve the proposed Access Conditions, unless the QCA is satisfied:
 - (i) it would be contrary to the public interest, including the public interest in having competition in markets;
 - (ii) it is reasonably expected to disadvantage Access Seekers, Access Holders, or other stakeholders which will not be parties to the Access Agreements containing the Access Conditions;
 - (iii) Aurizon Network has failed to provide Access Seekers with the report required by **clause 6.13.2(a)**; or
 - (iv) it would contravene a provision of this Undertaking or the Act.
- (f) To the extent that only some or none of the Access Seekers agree to the Access Conditions sought by Aurizon Network during the period in **clause 6.13.2(c)**, the QCA may approve the proposed Access Conditions if it is satisfied that:
 - (i) the Access Conditions are reasonably required in order to mitigate Aurizon Network's exposure to the Additional Risks associated with providing Access;
 - (ii) Aurizon Network's exposure to the Additional Risks would not be:
 - (A) reasonably mitigated by an Access Agreement which permits Aurizon Network to charge Access Charge calculated in accordance with a Reference Tariff based on the Approved WACC and 100% Take or Pay commitment; or
 - (B) more efficiently mitigated through insurance or other financial instruments;
 - (iii) to the extent there are risks not mitigated by other Access Conditions being sought, and Aurizon Network will receive monetary compensation for them, that the compensation is reflective of the possible outcomes and probabilities of the outcomes as a consequence of such risks;

- (iv) the proposed Access Conditions would not be contrary to the public interest, including the public interest in having competition in markets;
 - (v) the proposed Access Conditions would not be reasonably expected to disadvantage Access Seekers, Access Holders, or other stakeholders which will not be parties to the Access Agreements containing the Access Conditions;
 - (vi) Aurizon Network has provided Access Seekers with the report required by **clause 6.13.2(a)**; and
 - (vii) the proposed Access Conditions would not contravene a provision of this Undertaking or the Act.
- (g) To the extent that the QCA refuses to approve some or all of the Access Conditions sought by Aurizon Network:
- (i) the QCA must publish its decision regarding the Access Conditions it approves (which may include Access Conditions not initially sought by Aurizon Network); and
 - (ii) Aurizon Network may, within thirty (30) days of the QCA's decision, give notice to the QCA, copied to the relevant Access Seeker, that Aurizon Network will proceed to negotiate Access with Access Seekers on the basis of the Access Conditions which have been approved by the QCA under this **clause 6.13**; and
 - (iii) unless Aurizon Network provides the notice in **clause 6.13.2(g)(ii)**, Aurizon Network will be deemed to have rejected the Access Conditions (if any) proposed by the QCA and the parties must recommence negotiations on the terms of the Standard Agreement, subject to **clause 8.2.1**.

6.13.3 Prohibited Access Conditions

- (a) Aurizon Network must not seek to impose, and the QCA will not approve under **clause 6.13.2**, any Access Condition that:
 - (i) restricts Access Seekers from raising disputes with the QCA or disclosing proposed Access Conditions or other contract terms to the QCA; or
 - (ii) requires Access Seekers or Access Holders to disclose information that is confidential to one or more of them to any other Access Holder or Access Seeker, in circumstances other than those permitted by this Undertaking,
- (b) Other than pursuant to the arrangements contemplated under **Part 8** (with the exception of **clause 8.7.1(a)(iv)**), Aurizon Network must not seek to impose, and the QCA will not approve under **clause 6.13.2**, any Access Condition that results in Aurizon Network earning an Access Charge or any other monetary consideration

(whether under an Access Agreement or other agreement) based on a Varied WACC or otherwise earning above the return provided by Reference Tariffs based on the Approved WACC, other than as approved by the QCA under **clause 6.13.2**.

Part 6A Extension of **Schedule F** values

6A.1 Overview

- (a) Prior to the Reset Date, **Schedule F** must be amended to include Reference Tariffs, Allowable Revenues and Gtk Forecasts for the Reset Period. This amendment is required because as at the Approval Date, the Undertaking does not include any values for these items for the Reset Period. In establishing the Reference Tariffs and Allowable Revenues relating to the Reset Period, certain parameters which are used in the calculation of the Reference Tariffs and Allowable Revenues will be updated. This **Part 6A** sets out the bases on which certain items used in the calculation of Reference Tariffs and Allowable Revenues must be updated, which are referred to as the Preliminary Limited Update Inputs and Limited Update Inputs.
- (b) The Reset Schedule F Preliminary Values are required because some inputs used in the calculation of the Approved WACC and the inflation rate (which are used in the calculation of the Reference Tariffs and Allowable Revenues) will not be available prior to the Reset Date.
- (c) The Reset Schedule F Values as they related to the Year commencing 1 July 2023 are only an update of the Reset Schedule F Preliminary Values, using the same methodology by which the Reset Schedule F Preliminary Values were determined, but reflecting updated values of the following items used in the calculations:
 - (i) the Risk Free Rate;
 - (ii) the inflation rate;
 - (iii) the Debt Risk Premium; and
 - (iv) the Tax Allowance,

and accordingly will not require consultation by the QCA.

6A.2 Calculation and submission of Reset ~~Schedule F~~ **Schedule F** Preliminary Values

- (a) Aurizon Network must, before 31 July 2022, submit to the QCA preliminary revisions to **Schedule F**:
 - (i) for the purpose of **clauses 7.2, 8.2, 9.2, 10.2 and 11.2** of **Schedule F**, include the 'Reference Tariff inputs' for the first Year of the Reset Period which will be developed in accordance with **clause 6A.4**;
 - (ii) for the purpose of **clauses 7.3, 8.3, 9.3, 10.3 and 11.3** of **Schedule F**, include the:
 - (A) Gtk Forecasts; and

- (B) Allowable Revenues, having regard only to the matters in **clause 6A.3**,
 - for each of the Years in the Reset Period; and
- (iii) unless all Access Agreements referred to in **clause 12(a) of Schedule F** will expire prior to the Reset Date, then for the purpose of **clause 12 of Schedule F**, include the Monthly System Forecasts based on the Gtk Forecast for each of the Months within the Reset Period,
 - (the **Reset Schedule F Preliminary Values**).
- (b) The Allowable Revenues (and therefore the 'Reference Tariff inputs') submitted as part of the Reset Schedule F Preliminary Values under **clause 6A.2(a)** must reflect:
 - (i) the Reset WACC that would apply as at 30 June 2022 as if the relevant references in the definitions of "Reset Risk Free Rate" and "Reset Debt Risk Premium" to 30 June 2023 were to 30 June 2022;
 - (ii) the Reset Inflation Rate that would apply as at 30 June 2022 as if the reference in the definition of "Reset Inflation Rate" to 1 July 2023 was to 30 June 2022;
 - (iii) the forecast Indirect Maintenance Cost Allowance for each Year in the Reset Period, the calculation of which must reflect a reasonable forecast cost basis of Aurizon Network's plant and inventory for the relevant Year; and
 - (iv) Non-Electric Operating Expenditure Allowance,
 - (the **Preliminary Limited Update Inputs**).

6A.3 Development of Allowable Revenue component of the Reset Schedule F Preliminary Values

The Allowable Revenue component of the Reset Schedule F Preliminary Values will be developed using only the following inputs:

- (a) a preliminary Reset WACC calculated in accordance with **clause 6A.2(b)(i)**;
- (b) a preliminary Reset Inflation Rate calculated in accordance with **clause 6A.2(b)(ii)**;
- (c) forecast Electric Operating Expenditure Allowance;
- (d) forecast Regulatory Asset Base values which include Equity Raising Costs;
- (e) Non-Electric Operating Expenditure Allowance;
- (f) forecast Indirect Maintenance Cost Allowance;
- (g) forecast direct maintenance costs;

- (h) forecast capital expenditure;
- (i) depreciation allowances;
- (j) calculation of Tax Allowance;
- (k) calculation of Working Capital Allowances; and
- (l) any annual adjustments approved by the QCA as Revenue Adjustment Amounts, Endorsed Variation Events or Review Events for the relevant Year in the Reset Period.

The depreciation component of Allowable Revenue will, for the Reset Period, apply the methodology used by the QCA in section 3.4 of the QCA's 2018 Decision in the calculation of Allowable Revenues for the period immediately prior to the Reset Period (unless there has been a material change in circumstances from that which existed as at the Approval Date) but with the rolling 20 year asset life to be reset at the commencement of the Reset Period, rather than at the commencement of the next regulatory period.

6A.4 Development of 'Reference Tariff input' component of Reset Schedule F Preliminary Values

The 'Reference Tariff input' component of the Reset Schedule F Preliminary Values will be developed using inputs, assumptions and proposed approaches including:

- (a) the inputs specified in **clauses 6A.3(a) to 6A.3(l)**;
- (b) Gtk Forecasts;
- (c) the continuation, discontinuation, creation and quantum of System Premiums, System Discounts and Expansion Tariffs; and
- (d) the allocation of costs between Coal Systems.

For clarity, any determination of the 'Reference Tariff input' will not have any impact on the Allowable Revenue determined under **clause 6A.3**.

6A.5 Calculation and submission of Reset Schedule F Values

- (a) Aurizon Network must, prior to 31 July 2023, submit to the QCA revisions to the Reset Schedule F Preliminary Values to reflect the Reset WACC and the Reset Inflation Rate, which will:
 - (i) for the purpose of **clauses 7.2, 8.2, 9.2, 10.2 and 11.2 of Schedule F**, include Reference Tariff inputs for each of the Years of the Reset Period;
 - (ii) for the purpose of **clauses 7.3, 8.3, 9.3, 10.3 and 11.3 of Schedule F**, include Gtk Forecasts and Allowable Revenues for each of the Years in the Reset Period; and
 - (iii) unless all Access Agreements referred to in **clause 12(a) of Schedule F** will expire prior to the Reset Date, then for the purpose of **clause 12 of Schedule F**, include Monthly

System Forecasts based on the GtK Forecast for each of the Months within the Reset Period,

(the **Reset Schedule F Values**).

- (b) The 'Reference Tariff inputs' and Allowable Revenues submitted as part of the Reset Schedule F Values under **clause 6A.5(a)**:
 - (i) must reflect:
 - (A) the Reset WACC;
 - (B) the Reset Inflation Rate;
 - (C) the Indirect Maintenance Cost Allowance; and
 - (D) the Non-Electric Operating Expenditure Allowance, (the Limited Update Inputs); and
 - (ii) will be updated to reflect adjustments to the Tax Allowance and Working Capital Allowance arising from the Reset WACC or Reset Inflation Rate being different to those amounts applicable as Preliminary Limited Update Inputs.

6A.6 Supporting documentation and change in rates or indices

- (a) Aurizon Network will provide to the QCA the supporting documentation, assumptions, modelling and calculations supporting the development of each of the Reset Schedule F Values and Reset Schedule F Preliminary Values.
- (b) If any third party index or rate required for the determination of any Preliminary Limited Update Input or Limited Update Input ceases to be produced in that form, Aurizon Network and a Majority of End Users may propose, and the QCA will consider and determine, the most appropriate alternative index or rate to be used for the purpose of **clause 6A.2(b)** or **6A.5(b)** (as applicable).

6A.7 Approval of Reset Schedule F Values

- (a) The QCA will:
 - (i) publish the proposed Reset Schedule F Preliminary Values and Reset Schedule F Values and, subject to confidentiality restrictions, the documentation referred to in **clause 6A.6(a)** provided by Aurizon Network to the QCA;
 - (ii) invite persons to make submissions on the proposed Reset Schedule F Preliminary Values and Reset Schedule F Values to the QCA within a reasonable period of time specified by the QCA; and
 - (iii) consider any submission it receives within that period of time.

- (b) The QCA:
- (i) must approve Aurizon Network's use of:
 - (A) the Preliminary Limited Update Inputs in its calculation of the Reset Schedule F Preliminary Values to the extent the QCA is satisfied that the Preliminary Limited Update Inputs have been calculated correctly and used in accordance with this Undertaking including that the forecast cost base of Aurizon Network's plant and inventory for the relevant Year is reasonable; and
 - (B) the Limited Update Inputs in the calculation of the Reset Schedule F Values to the extent the QCA is satisfied that the Limited Update Inputs have been calculated correctly and used in accordance with this Undertaking; and
 - (ii) may approve all other matters, calculations, inputs and methodologies used in the calculation of the Reset Schedule F Preliminary Values or Reset Schedule F Values (as applicable) if the QCA is satisfied that:
 - (A) those other matters, calculations, inputs and methodologies (as applicable) are appropriate; or
 - (B) if applicable, Aurizon Network has in all material respects addressed the matters referred to in the relevant notice by the QCA under **clause 6A.7(e)**.
- (c) The QCA will assess the appropriateness of all matters relevant to the development of the Reset Schedule F Preliminary Values (other than the Preliminary Limited Update Inputs), having regard to, but not bound by, the approaches taken to the development of the corresponding values for the Years prior to the Reset Period.
- (d) If the QCA is considering refusing to approve the Reset Schedule F Preliminary Values or the Reset Schedule F Values:
- (i) it must publish a draft of its decision (including a statement of both its reasons and the way in which it considers the Reset Schedule F Preliminary Values or the Reset Schedule F Values (as applicable) should be amended);
 - (ii) Aurizon Network may, within twenty (20) Business Days after being given that draft decision (or such longer period as agreed by the QCA):
 - (A) revise the Reset Schedule F Preliminary Values or the Reset Schedule F Values (as applicable); and
 - (B) if applicable, provide additional information supporting its view that the Reset Schedule F

Preliminary Values or the Reset Schedule F Values (as applicable) should be approved;

- (iii) the QCA may:
 - (A) publish the proposed revised Reset Schedule F Preliminary Values or the Reset Schedule F Values (as applicable) and, subject to confidentiality restrictions, the supporting documentation provided by Aurizon Network;
 - (B) invite persons to make submissions on the revised Reset Schedule F Preliminary Values (other than the Preliminary Limited Update Inputs) or the Reset Schedule F Values (as applicable) (other than the Limited Update Inputs) to the QCA within a reasonable period of time specified by the QCA; and
 - (C) consider any submission it receives within that period of time; and
- (iv) the QCA must consider the additional information and submissions when deciding whether to approve or refuse to approve the Reset Schedule F Preliminary Values or the Reset Schedule F Values (as applicable) or revised Reset Schedule F Preliminary Values or Reset Schedule F Values (as applicable).
- (e) If the QCA refuses to approve any of the Reset Schedule F Preliminary Values or the Reset Schedule F Values (as applicable) (including as revised):
 - (i) the QCA must give Aurizon Network a notice which:
 - (A) sets out the QCA's decision (including a statement of both its reasons and the way in which it considers the Reset Schedule F Preliminary Values or the Reset Schedule F Values (as applicable) should be amended); and
 - (B) a direction to Aurizon Network to resubmit the Reset Schedule F Preliminary Values or the Reset Schedule F Values (as applicable);
 - (ii) Aurizon Network must, in the absence of a manifest error by the QCA, resubmit the Reset Schedule F Preliminary Values or the Reset Schedule F Values with amendments (as applicable) as directed by the QCA; and
 - (iii) Aurizon Network acknowledges that **clauses 6A.7(a) to 6A.7(d)** apply to the resubmitted Reset Schedule F Preliminary Values or Reset Schedule F Values (as applicable).

- (f) If Aurizon Network does not comply with a notice given by the QCA under **clause 6A.7(e)** then the QCA may prepare, and approve, Reset Schedule F Preliminary Values or the Reset Schedule F Values (as applicable).

Part 7: Available Capacity allocation and management

7.1 Application

- (a) This **Part 7** addresses the allocation and management of Capacity, including in circumstances where there is insufficient Available Capacity to satisfy all of the Access Applications submitted to Aurizon Network. In particular, under its provisions:
 - (i) without limiting any other rights or obligations under this Undertaking, Aurizon Network may refuse to grant Access Rights if the relevant Access Seeker has not demonstrated to Aurizon Network's satisfaction (acting reasonably and in good faith) that it can utilise those Access Rights (**clause 7.2.1**).
 - (ii) Aurizon Network must maintain a Capacity Notification Register and a Committed Capacity Register (**clause 7.2.2** and **clause 7.2.3**).
 - (iii) Aurizon Network will be obliged to give priority to the granting of Access Rights to a Renewing Access Seeker in respect of a Renewal in certain circumstances (**clause 7.3**).
 - (iv) Standard Access Agreements permit an Access Holder or an Access Holder's Customer to Transfer Access Rights in accordance with this Undertaking. Aurizon Network has obligations in relation to the allocation of Capacity to facilitate a Transfer (**clause 7.4.1**).
 - (v) Short Term Transfers will be required to meet specified requirements (**clause 7.4.3(c)**).
 - (vi) Standard Access Agreements permit an Access Holder to relinquish Access Rights in accordance with this Undertaking. Aurizon Network has obligations in relation to the management of that relinquishment (**clause 7.4.8**).
 - (vii) Aurizon Network will notify Access Seekers if their Access Applications are Mutually Exclusive Access Applications and assist them to modify their Access Applications to seek to avoid them being Mutually Exclusive Access Applications (**clause 7.5.1**).
 - (viii) Where Aurizon Network has received Mutually Exclusive Access Applications, Aurizon Network will form a queue to determine which Access Seeker will be allocated Available Capacity (**clause 7.5.2**).

However, these provisions for Mutually Exclusive Access Applications do not apply where the allocation occurs under **Part 8 (clause 7.5.2(a))**.

- (b) A diagrammatic representation of the Capacity allocation process for Mutually Exclusive Access Applications is set out in **Schedule H**.
- (c) For the purposes of the Act, the treatment of Access Seekers differently as a result of, or in accordance with, **clause 7.3, 7.4.2 or 7.5.2** is permitted and to that extent does not offend the Act.
- (d) Except where otherwise expressly provided in this **Part 7** and without limitation to **clause 7.1(c)**, in the performance of its obligations and the exercise of its rights under this **Part 7**, Aurizon Network must not unfairly differentiate between Access Seekers (or, as applicable, Customers) on the basis of the identity of a funder of a Pre-feasibility Study, a Feasibility Study or an Expansion. For example, Aurizon Network will not provide an Access Seeker (or, as applicable, a Customer) with priority in the allocation of Capacity in respect of an Expansion on the basis that Aurizon Network is providing funding for the Expansion, over another Access Seeker (or, as applicable, a Customer) with a different source of funding.
- (e) Nothing in **clauses 7.4.1, 7.3, 7.4.2 or 7.5.2** obliges Aurizon Network to grant Access Rights if there is insufficient Available Capacity to provide those Access Rights.
- (f) Nothing in **clauses 7.4.1** (Transfers), **7.4.8** (Relinquishments) and **7.6** (Capacity resumption) affects the terms of an Access Agreement or Train Operations Deed executed before the Approval Date, unless the parties to the relevant document expressly agree to vary that document and adopt **clauses 7.4.1, 7.4.8 or 7.6**.

7.2 Capacity allocation and registers

7.2.1 *General requirement for allocation*

Despite any other provision in this Undertaking, Aurizon Network may refuse to allocate Available Capacity in respect of an Access Application if the Access Seeker has not demonstrated to Aurizon Network's satisfaction (acting reasonably and in good faith) that the Access Seeker has a reasonable likelihood of being able to utilise the Access Rights requested from the time when the Access Rights are proposed by the Access Seeker to commence, based on the following factors:

- (a) whether the Access Seeker:
 - (i) (or its Customer) has secured, or is reasonably likely to secure, Supply Chain Rights;
 - (ii) if not a Railway Operator, has secured, or is reasonably likely to secure, a rail haulage agreement for the operation of the Train Services the subject of the Access Application;

- (iii) if a Railway Operator, has entered into, or is reasonably likely to enter into, a rail haulage agreement with a Customer to enable it to run Train Services to utilise the Access Rights sought (provided that any consideration of reasonable likelihood must disregard the effect of granting the Access Rights to the Railway Operator or the Railway Operator's ability to attract a Customer in the future);
 - (iv) (or Railway Operator) is reasonably likely to have access to facilities (including Rollingstock, provisioning facilities, maintenance facilities and storage facilities) to enable it to run Train Services to utilise the Access Rights sought;
 - (v) (or its Customer) is reasonably likely to have sufficient product (whether through the anticipated output of a mine or otherwise) to utilise the Access Rights sought (taking into account any other Access Rights held by the Access Seeker or its Customer in respect of product from the same origin);
 - (vi) has been actively participating in the negotiation process in accordance with **Part 4**; and
- (b) where the only party that has applied for Access is a Railway Operator, whether the Railway Operator no longer meets the criteria outlined in **clause 4.9(a)(ii)(A)** and **(B)**.

7.2.2 Capacity Notification Register

- (a) Aurizon Network must maintain a Capacity Notification Register which contains an Access Seeker's (and, if applicable, its Customer's) details if:
- (i) Aurizon Network has ceased negotiations with an Access Seeker in accordance with **clauses 4.5(e) 4.5(j) or 4.8(d)** (in respect of all or part of the Access Rights sought by the Access Seeker);
 - (ii) the Access Seeker (and, if applicable, its Customer) requests Aurizon Network to include it in the Capacity Notification Register; and
 - (iii) Aurizon Network, acting reasonably, is satisfied the Access Seeker (or its Customer) has, or is in a queue to obtain, Supply Chain Rights in respect of an unloading facility.
- (b) The Capacity Notification Register must contain:
- (i) the identity of each Access Seeker (or its Customer) which has requested it be included;
 - (ii) the nature of the Access Seeker's interest;
 - (iii) the date on which the applicable Access Application was received, or was deemed to have been received, in accordance with **clause 4.4(b)** by Aurizon Network.

- (c) Every six (6) Months after forming the Capacity Notification Register, Aurizon Network must confirm with each Access Seeker (or Customer) on the register that:
 - (i) it wishes to remain on the Capacity Notification Register; and
 - (ii) it has, or is in a queue to obtain, Supply Chain Rights in respect of an unloading facility.
- (d) If there is Available Capacity or a proposed Expansion which, if constructed, would create Available Capacity, then Aurizon Network must notify each person in the Capacity Notification Register who could utilise that existing or potential Available Capacity (as applicable) of the nature and extent of that existing or potential Available Capacity.
- (e) If a person notified under **clause 7.2.2(d)** submits an Access Application within one (1) Month after being given that notice, then that Access Application is deemed, for the purposes of **clause 4.4(b)** and in respect of the Access Rights the Access Seeker nominated for inclusion in the Capacity Notification Register, to have been received by Aurizon Network on the date Aurizon Network notified the relevant Access Seeker under **clause 7.2.2(d)**.
- (f) A person will remain on the Capacity Notification Register until:
 - (i) that person fails to comply with **clause 7.2.2(c)**; or
 - (ii) Aurizon Network notifies that person in accordance with **clause 7.2.2(d)**.

7.2.3 Committed Capacity Register

- (a) Aurizon Network must maintain a Committed Capacity Register that identifies:
 - (i) each Access Holder with Access Rights under an Access Agreement;
 - (ii) DTMR in respect of its Committed Capacity;
 - (iii) any other party that has an interest in existing Access Rights and wishes to be included in the Committed Capacity Register and has notified Aurizon Network of that interest, in which case, the register must include:
 - (A) the Committed Capacity or Access Rights in which they have an interest; and
 - (B) the nature of that interest.
- (b) Where an Access Seeker requests Access which will:
 - (i) commence within two (2) Years after the expiration of an existing Access Right (other than an Access Right in respect of coal carrying Train Services); and

- (ii) utilise Capacity that will only become available following the expiration of that Access Right,

Aurizon Network will, prior to providing an Indicative Access Proposal, use reasonable endeavours to notify the parties who are identified in the Committed Capacity Register as having an interest in the existing Access Rights of the existence of the Access Application. Failure to give such notification is not a default under this Undertaking and does not invalidate or prejudice any Access Agreement that may have been entered into by Aurizon Network provided that Aurizon Network has acted reasonably and in good faith.

7.3 Renewals

- (a) This **clause 7.3** sets out provisions that apply where all or any part of an Access Holder's existing Access Rights will expire and:

- (i) that Access Holder (where the Access Holder has no Customer); or
- (ii) the person nominated by the Access Holder's Customer in writing to Aurizon Network (and, for clarity, that Customer may nominate itself),

(**Renewing Access Seeker**) wishes to hold or to continue to hold (as applicable) equivalent Access Rights (based on the Access Holder's Access Rights immediately prior to that expiry), subject to **clause 7.3(b)**, for a further term commencing immediately after those existing Access Rights will expire (that is, a **Renewal**).

- (b) For the purpose of **clause 7.3(a)**, Aurizon Network will disregard any change to the origin or destination of the relevant Train Services in considering whether the relevant Access Rights are equivalent Access Rights so long as the Train Services for the Renewal:

- (i) continue to have substantially the same Train Paths as the existing Train Services. For clarity, the Train Services for the Renewal may include a longer haul than the existing Train Services;
- (ii) do not adversely affect the ability of existing Access Holders to use their Access Rights;
- (iii) have an origin which is located in the same Track Segment as the origin of the Train Services under the existing Access Rights; and
- (iv) are not in excess of those existing Access Rights under the relevant Access Holder's existing Access Agreement. For clarity, the Train Services for the Renewal may include a longer haul than the existing Train Services and will not be considered to be in excess of the existing Access Rights if **paragraphs (i), (ii) and (iii)** above are satisfied.

- (c) For clarity:
- (i) a Renewing Access Seeker may elect to renew only part of its existing Access Rights;
 - (ii) that part of the Renewing Access Seeker's existing Access Rights not Renewed will become Available Capacity on the expiry of those existing Access Rights;
 - (iii) an Access Holder does not have Access Rights beyond the term of its Access Agreement; and
 - (iv) a Renewal includes Access Rights that were granted to the Renewing Access Seeker as a Transferee if the Renewing Access Seeker's existing Access Agreement includes those transferred Access Rights at the date of expiry of that Access Agreement.
- (d) Despite any provision in **Part 4**, Aurizon Network must not:
- (i) negotiate the provision of Access that will use Capacity that will become Available Capacity on the expiry of an existing Access Right; and
 - (ii) enter into an Access Agreement in relation to such Capacity, with a person other than the relevant Renewing Access Seeker unless and until:
 - (iii) the relevant Access Holder, where the Access Holder has no Customer, or otherwise the relevant Access Holder's Customer, has notified Aurizon Network that the Access Holder does not intend to seek a Renewal; or
 - (iv) the Renewing Access Seeker has not (other than because of a delay by or breach of this Undertaking by Aurizon Network) executed an Access Agreement for that Capacity with Aurizon Network under this **clause 7.3** at least twelve (12) Months prior to the expiry of the Access Rights (or such later date as agreed between Aurizon Network and the Renewing Access Seeker).
- (e) Aurizon Network may refuse to negotiate, or to enter into, an Access Agreement with a Renewing Access Seeker for a Renewal more than five (5) years prior to the expiry of the Access Rights. For clarity, a refusal by Aurizon Network to negotiate an Access Agreement as a result of the operation of this **clause 7.3(e)** does not affect the Renewing Access Seeker's right to seek a Renewal under this **clause 7.3** within the period that is five (5) years prior to the expiry of the Access Rights.
- (f) If a Renewing Access Seeker is seeking a Renewal at least twelve (12) Months (or such other later date as agreed between Aurizon Network and the Renewing Access Seeker) but no more than sixty (60) Months (or such earlier date as agreed between Aurizon Network

and the Renewing Access Seeker) prior to the expiry of the relevant Access Rights, then:

- (i) the term of an Access Agreement relating to the Renewal must be:
 - (A) for coal carrying Train Services, the lesser of ten (10) years and the remaining life of the relevant mine (as evidenced to Aurizon Network's satisfaction (acting reasonably) by the Renewing Access Seeker); or
 - (B) for other Train Services, the lesser of ten (10) years and the same length of time as the term of the relevant current Access Agreement; and
- (ii) if:
 - (A) the Renewing Access Seeker's Access Application is not seeking a Renewal for; or
 - (B) the Renewing Access Seeker does not agree to an Access Agreement for,
 - a term referred in **clause 7.3(f)(i)**, then the Renewing Access Seeker's Access Application will not be treated as an Access Application for a Renewal under this **clause 7.3**.
- (g) While this **clause 7.3** sets out how Aurizon Network will differentiate in the treatment of a Renewing Access Seeker as compared to other Access Seekers, this **clause 7.3** does not affect the rights and obligations of the Renewing Access Seeker or Aurizon Network under **Part 4** or **Part 5** or the remaining provisions of this **Part 7** except as set out in this **clause 7.3**.
- (h) For clarity:
 - (i) a Renewing Access Seeker must complete and submit an Access Application for Access Rights it is seeking to renew; and
 - (ii) subject to this **Part 7**, the negotiations for those Access Rights will be conducted in accordance with **Part 4** and **Part 5**, including:
 - (A) the Negotiation Cessation Notice provisions under **clause 4.13**;
 - (B) the Renewing Access Seeker and Aurizon Network beginning negotiations as soon as reasonably possible once the relevant Negotiation Period has commenced under **clause 4.11.1(a)**; and
 - (C) both the Renewing Access Seeker and Aurizon Network negotiating the terms of the relevant

Access Agreement for the Renewal acting reasonably and in good faith under **clauses 5.1(c) and 5.1(d)**.

- (i) Aurizon Network acknowledges that any provision under **Part 4** which permits Aurizon Network:
 - (i) to treat an Access Application as being withdrawn (except where the Access Seeker expressly withdraws the Access Application); or
 - (ii) to cease negotiation under **clause 4.11.1(d)(v)** or otherwise issue a Negotiation Cessation Notice because there is insufficient Available Capacity,does not apply in respect of a Renewal.

7.4 Dealing with Access Rights

7.4.1 Transfers

- (a) An Access Holder may only assign, novate or otherwise transfer (**Transfer**) the Access Holder's interest in an Access Agreement to a third party or itself in accordance with the terms of that Access Agreement.
- (b) Subject to **clause 7.4.1(a)**, an Access Holder (**Transferor**) may undertake a Transfer to another Access Holder or an Access Seeker (or a Customer), or itself (**Transferee**) in accordance with this **clause 7.4**.
- (c) **Schedule H** shows, diagrammatically, the process to effect a Long Term Transfer and Short Term Transfer.
- (d) For the purpose of this **Part 7**:
 - (i) a Transfer is a transfer of any of an Access Holder's Access Rights (or the Access Rights held for the purpose of providing Train Services for a Customer) for a term which is no longer than the remaining term of the Access Agreement but excluding:
 - (A) a Customer Initiated Transfer; or
 - (B) a change in the nomination of a Train Operator by an Access Holder;
 - (ii) a Short Term Transfer is a Transfer of Access Rights:
 - (A) for a Transfer Period of two (2) years or less; and
 - (B) in respect of which the Transferee (or its Customer) has an existing Access Agreement under which the Transferred Access Rights can be added,but excluding a Customer Initiated Transfer;

- (iii) a Long Term Transfer is a Transfer of Access Rights which is not a Short Term Transfer; and
- (iv) Port Precinct means each of the following:
 - (A) Port of Abbot Point;
 - (B) Port of Hay Point (including Hay Point Coal Services Coal Terminal and Dalrymple Bay Coal Terminal); and
 - (C) Port of Gladstone (including the RG Tanna Coal Terminal, Wiggins Island Coal Export Terminal and domestic coal terminals in the vicinity of Gladstone).

7.4.2 **Transfer Notice**

- (a) A Transferor and Transferee must provide written notice of a proposed Transfer to Aurizon Network (**Transfer Notice**) which specifies:
 - (i) the date on which the Transfer is to take effect (**Transfer Date**) and to terminate (if any);
 - (ii) the Access Rights which the Transferor proposes to Transfer (**Nominated Access Rights**) by describing:
 - (A) the number and type of Train Services to be transferred (which must be an even number of Train Services (each service being a one way Train Service)); and
 - (B) the existing origin and destination of the Nominated Access Rights;
 - (iii) the Access Rights the Transferee proposes to acquire from the Transferor (**Transferred Access Rights**) by describing:
 - (A) the number and type of Train Services;
 - (B) the proposed origin and destination; and
 - (C) any Capacity which is required in addition to the Available Capacity that will be created by the relinquishment of the Nominated Access Rights as part of the proposed Transfer (**Ancillary Access Rights**);
 - (iv) the Access Agreement which the Nominated Access Rights are proposed to be transferred from, which must be the Transferor's Access Agreement which has been entered into first in time relating to the origin and destination of the Nominated Access Rights (to the extent sufficient to satisfy the Transfer);

- (v) either:
 - (A) the Access Agreement under which the Transferred Access Rights are proposed to be added which must:
 - (1) have existing Train Service Entitlements from the origin for the Transferred Access Rights; and
 - (2) where there is more than one agreement that satisfies **clause 7.4.2(a)(v)(A)(1)**, must be the most recently executed Access Agreement; or
 - (B) if there is no existing Access Agreement which has Train Service Entitlements from the origin for the Transferred Access Rights, a short form Access Application must be completed by the Transferee which includes the information listed in **clause 6 of Schedule B**, in respect of the Transferred Access Rights;
- (vi) evidence that the Transferor's and Transferee's Customers (as applicable) have consented to the Transfer; and
- (vii) evidence that the Transferee (or its Customer) will be reasonably likely to be able to utilise the Transferred Access Rights based on whether:
 - (A) the Transferee (or its Customer) has secured, or is reasonably likely to secure, Supply Chain Rights for the Transferred Access Rights from the Transfer Date;
 - (B) unless the Transferee is a Railway Operator, the Transferee (or its Customer) has secured or is reasonably likely to secure, a rail haulage agreement for the Transferred Access Rights from the Transfer Date;
 - (C) the Transferee or its Railway Operator is reasonably likely to have access to facilities (including Rollingstock, provisioning facilities, maintenance facilities and storage facilities) to enable it to run Train Services to utilise the Transferred Access Rights; and
 - (D) the Transferee (or its Customer) is reasonably likely to have sufficient product (whether through the anticipated output of a mine or otherwise) to utilise the Transferred Access Rights.

- (b) If a Transfer Notice includes a short form Access Application in accordance with **clause 7.4.2(a)(v)(B)**, subject to this **Part 7**, the negotiation process for those Transferred Access Rights will be conducted on an expedited basis in accordance with **Part 4**.
- (c) A Transfer Notice for a Short Term Transfer must be provided:
 - (i) if Ancillary Access Rights are not required, at least five (5) Business Days prior to close of Train Orders for the period commencing on the Transfer Date; and
 - (ii) if Ancillary Access Rights are required, at least seven (7) Business Days prior to close of Train Orders for the period commencing on the Transfer Date.
- (d) A Transfer Notice for a Long Term Transfer must be provided:
 - (i) if no Ancillary Access Rights are required, 20 Business Days prior to the Transfer Date; or
 - (ii) if Ancillary Access Rights are required, 25 Business Days prior to the Transfer Date.

7.4.3 *Criteria for a Transfer to take effect*

- (a) Subject to **clause 7.4.3(b)** and **clause 7.4.3(c)**, a Transfer must meet the following conditions:
 - (i) the origin for the Transferred Access Rights is on the same Mainline Path as the origin for the Nominated Access Rights;
 - (ii) the destination for the Transferred Access Rights is the same as the destination for the Nominated Access Rights or is in the same Port Precinct as the destination for the Nominated Access Rights;
 - (iii) the Train Services for the Transferred Access Rights are the same as the nature or type of Train Services for the Nominated Access Rights; and
 - (iv) the information or evidence required by **clause 7.4.2(a)** has been provided.
- (b) If a Long Term Transfer:
 - (i) satisfies the conditions of **clause 7.4.3(a)**; and
 - (ii) requires Ancillary Access Rights,

Aurizon Network must determine whether the Ancillary Access Rights cause the Transfer and another Access Application(s) to become Mutually Exclusive Access Applications. If the Transfer and another Access Application(s) are Mutually Exclusive Access Applications:
 - (iii) Aurizon Network must promptly provide written notice to the Transferee;

- (iv) if:
 - (A) the Transfer Notice included a short form Access Application in accordance with **clause 7.4.2(a)(v)(B)**, the part of that Access Application that relates to the Ancillary Access Rights will be subject to **clause 7.5**; or
 - (B) otherwise, a short form Access Application in respect of the Ancillary Access Rights will be deemed to have been submitted by the Transferee on the date of the Transfer Notice and that Access Application will be subject to **clause 7.5**,

and, to the extent that Aurizon Network requires further information in respect of the Ancillary Access Rights in order to determine whether there is sufficient Available Capacity, it may request such additional information from the Transferee; and

- (v) the transfer will not take effect unless and until the Ancillary Access Rights are granted to the Transferee in accordance with **clause 7.5**. Aurizon Network must provide written notice to the Transferor and Transferee once the Ancillary Access Rights are granted.
- (c) If a Short Term Transfer:
 - (i) satisfies the conditions of **clause 7.4.3(a)**; and
 - (ii) requires Ancillary Access Rights,

Aurizon Network must undertake a Rapid Capacity Assessment to determine whether there is sufficient Available Capacity for the Ancillary Access Rights. Aurizon Network must promptly provide written notice to the Transferor and Transferee of the outcomes of the Rapid Capacity Assessment including full details of the assessment and the transfer will not take effect unless and until the Ancillary Access Rights are granted to the Transferee. Aurizon Network must provide written notice to the Transferor and Transferee that the Ancillary Access Rights are granted to the extent the Rapid Capacity Assessment determines there is sufficient Available Capacity.

- (d) If Aurizon Network determines (acting reasonably) a Transfer does not comply with this **clause 7.4.3** (including if there is insufficient Available Capacity under **clause 7.4.3(c)**), it must promptly provide written notice (including reasons) to the Transferor and the Transferee.

7.4.4 Effect of Short Term Transfers

If a Short Term Transfer meets the requirements of **clause 7.4.3** (and there is sufficient Available Capacity under **clause 7.4.3(c)**, if applicable), Aurizon Network must promptly provide the Transferor and Transferee (and their

respective Train Operators, if any) with written notice approving the Short Term Transfer and providing that;

- (a) no Transfer Fee or Relinquishment Fee is payable;
- (b) the Transferred Access Rights will be taken to be Access Rights for additional Train Service Entitlements for the relevant Train Service Type under the Transferee's nominated Access Agreement for the Transfer Period;
- (c) the Nominated Access Rights will be taken to have been relinquished for the Train Service Type specified in the Transfer Notice for the Transfer Period;
- (d) the Transferor and the Transferee will be taken to have varied the relevant Access Agreement (and, Train Operations Deeds (if any)) by the issue of replacement schedules to those relevant agreements to the relevant Transferor and Transferee (and Train Operator if applicable) to (as applicable) exclude the Nominated Access Rights and include the Transferred Access Rights for the Transfer Period; and
- (e) the Transferee's Access Agreement will be taken to be varied by the issue of replacement schedules to include, in respect of the Transferred Access Rights, an Access Charge Rate that is set by reference to the same Reference Tariff as the Nominated Access Rights.

7.4.5 Effect of Long Term Transfers

(a) If a Long Term Transfer meets the requirements of **clause 7.4.3(a)** (and the Ancillary Access Rights are granted in accordance with **clause 7.4.3(b)**), Aurizon Network must promptly provide the Transferor and Transferee (and their respective Train Operators, if any) written notice approving the Long Term Transfer and then on and from the Transfer Date (or such later date as agreed by the Transferor, Transferee and Aurizon Network):

- (i) the Nominated Access Rights will be taken to have been relinquished for the Train Service Type specified in the Transfer Notice for the Transfer Period; and
- (ii) the Transferred Access Rights will be taken to be Access Rights for Train Service Entitlements for the relevant Train Service Type under the Transferee's nominated Access Agreement for the Transfer Period,

provided that each of the matters in **clause 7.4.5(b)** are complied with.

(b) Each of the parties to a Long Term Transfer referred to in **clause 7.4.5(a)** will promptly after the approval of the Long Term Transfer do the following:

- (i) Aurizon Network and the Transferor enter into an agreement to vary the terms of the Transferor's Access Agreement to address the relinquishment of the Nominated Access Rights (including any variations to the Access Charge Rates);
- (ii) if the Transferred Access Rights are being granted under an existing Access Agreement between Aurizon Network and the Transferee, Aurizon Network and the Transferee enter into an agreement to vary the terms of that Access Agreement to accommodate the Transferred Access Rights (including any variations to the Access Charge Rates and the term of the agreement);
- (iii) if the Transferred Access Rights are being granted under a new Access Agreement between Aurizon Network and the Transferee, that Access Agreement:
 - (A) has been negotiated and agreed in accordance with **clause 7.4.2(b)**; and
 - (B) (except for a condition in relation to the grant of the Transferred Access Rights taking effect under this **clause 7.4.5(b)**) is unconditional and binding upon the Transferee;
- (iv) with the consent of the Transferor and the Transferee, Aurizon Network and the relevant Train Operator(s) (if any) vary the relevant Train Operations Deeds (if any) by the issue of replacement schedules to those relevant agreements to the relevant Train Operator(s) (if applicable) to (as applicable) exclude the Nominated Access Rights and include the Transferred Access Rights for the Transfer Period;
- (v) the Transferee provides Aurizon Network with security in respect of the Transferred Access Rights to the extent reasonably requested by Aurizon Network in accordance with this Undertaking; and
- (vi) payment of a Transfer Fee (if applicable).

7.4.6 Transfer Fee and Adjustment Charges

- (a) Subject to **clause 7.4.6(d)**, a Transferor must pay a fee (Transfer Fee) to Aurizon Network if:
 - (i) a Transfer is a Long Term Transfer; or
 - (ii) both the Nominated Access Rights and the Transferred Access Rights are not for coal carrying services.
- (b) Aurizon Network must:
 - (i) calculate the Transfer Fee; and

- (ii) notify the Transferor of the amount of the Transfer Fee and how the Transfer Fee was calculated, including details of any assumptions made when calculating the Transfer Fee and reasons for those assumptions,

at the following times:

- (iii) if a Transfer Notice has been provided;
 - (A) where no Ancillary Access Rights are required, within two (2) Business Days of the Transfer Notice; or
 - (B) where Ancillary Access Rights are required, within three (3) Business Days of Aurizon Network determining that there is sufficient Available Capacity for the Ancillary Access Rights; and
 - (iv) otherwise, promptly following a request by an Access Holder considering a transfer.
- (c) The Transfer Fee is the amount equivalent to the present value, calculated at the Discount Rate, of the payment of the aggregate TOP Charges for the relevant Train Service Types that would have been payable for the Transfer Period assuming:
- (i) the Nominated Access Rights were not transferred; and
 - (ii) the Train Services were not operated for the Transferor for a reason other than Aurizon Network Cause,
- (PV Amount)** less the amount which is the product of the PV Amount and the Reduction Factor.
- (d) Despite any other provision in this **clause 7.4**, no Transfer Fee is payable:
- (i) where the Transfer Fee is calculated to be an amount that is less than zero; or
 - (ii) in the case of a Short Term Transfer or a Customer Initiated Transfer.
- (e) If the Transferor has not paid (or commenced a dispute in respect of the calculation of) the Transfer Fee within twenty (20) Business Days after the latest of:
- (i) the Transfer Date;
 - (ii) the date Aurizon Network gives the Transferor a notice under **clause 7.4.6(b)(iii)**;
 - (iii) the date that Aurizon Network gives the Transferor a valid tax invoice in respect of the Transfer Fee; and
 - (iv) in respect of payment only, the date any dispute regarding the calculation of the Transfer Fee is determined,

then Aurizon Network may give the Transferor a notice (**Transfer Cancellation Notice**) with respect to Nominated Access Rights specified in the Transfer Notice in which case:

- (v) the Transfer Notice is deemed to have never been given by the Transferor; and
 - (vi) the Nominated Access Rights that were the subject of the Transfer Notice will not be Transferred to the Transferee.
- (f) For the avoidance of doubt, the giving of a Transfer Cancellation Notice does not prevent the Transferor from subsequently giving Aurizon Network a new Transfer Notice in respect of the same Nominated Access Rights.
- (g) Where, following a Transfer, the Transferor's Access Agreement terminates, the Transferee agrees to pay all Adjustment Charges (**Transferred Adjustment Charges**) that, but for the Transfer of the Access Rights, would have become payable by the Transferor in relation to Train Services operated for the Transferor prior to the commencement of the Transferee's new Access Agreement unless the Transferee and Transferor agree to some other arrangement (which is enforceable by Aurizon Network) in respect of the Transferred Adjustment Charges and provide notice of that agreement to Aurizon Network.

7.4.7 Customer Initiated Transfers

- (a) Where an Access Holder holds any of its Access Rights for the purpose of providing Train Services for a Customer, that Customer may seek to transfer those Access Rights to itself or to another Railway Operator so that the Customer or, if relevant, another Railway Operator, becomes the Access Holder in respect of those Access Rights provided that the Customer is not seeking any change to the origin and destination of, or the commodity for, the Access Rights (**Customer Initiated Transfer**).
- (b) Where a Customer seeks to undertake a Customer Initiated Transfer, the Customer must provide written notice to Aurizon Network and the Access Holder (**CIT Notice**) which:
- (i) specifies the date on which the Customer Initiated Transfer is to take effect (**CIT Date**) and to terminate (if any);
 - (ii) specifies the Access Rights which the Customer is seeking to transfer from the Access Holder to itself (**CIT Access Rights**) by describing:
 - (A) the number and type of Train Services to be transferred (which must be an even number of Train Services (each service being a one way Train Service)) from the Access Holder; and
 - (B) the origin and destination of the Access Rights; and

- (iii) specifies any changes to the type of Train Services which the Customer requires once the Customer Initiated Transfer takes effect and
 - (iv) where the Customer Initiated Transfer is to another Railway Operator, includes the consent of that Railway Operator.
- (c) A Customer Initiated Transfer must meet the following conditions:
- (i) the Customer or, if relevant, the Railway Operator agrees to pay all Adjustment Charges (**Transferred Adjustment Charges**) that, but for the transfer of the CIT Access Rights, would have become payable by the Access Holder in relation to Train Services operated for the Access Holder utilising the CIT Access Rights prior to the commencement of the Customer's (or Railway Operator's) new Access Agreement; and
 - (ii) the Customer (or Customers where all Customers for the origin initiate the Customer Initiated Transfer) is the sole end Customer (or Customers) of the Train Services utilising the CIT Access Rights.
- (d) If a Customer Initiated Transfer complies with **clause 7.4.7(b)** and **clause 7.4.7(c)**, Aurizon Network must promptly provide the Customer (and, where the Customer Initiated Transfer is to another Railway Operator, that Railway Operator) and the Access Holder written notice approving the Customer Initiated Transfer and then on and from the CIT Date (or such later date as agreed by the Customer and Aurizon Network):
- (i) the CIT Access Rights will be taken to have been relinquished for the Train Service Type specified in the CIT Notice from the Access Holder's Access Agreement; and
 - (ii) those CIT Access Rights will be taken to be Access Rights for Train Service Entitlements for the relevant Train Service Type under a new Access Agreement with either the Customer or, where the Customer Initiated Transfer is to another Railway Operator, that Railway Operator on the same terms as the Access Holder's Access Agreement.
- (e) Each of the parties to a Customer Initiated Transfer referred to in **clause 7.4.7(d)** will promptly after the approval of the Customer Initiated Transfer do the following:
- (i) Aurizon Network and the Access Holder will enter into an agreement to vary the terms of the Access Holder's Access Agreement to address the relinquishment of the CIT Access Rights (including any variations to the Access Charge Rates);
 - (ii) Aurizon Network and the Customer will enter into a new Access Agreement on the same terms as the Access

Holder's Access Agreement except to the extent the Customer notified Aurizon Network of any changes to the types of Train Services in the CIT Notice; and

- (iii) the Customer will provide Aurizon Network with security in respect of the CIT Access Rights to the extent reasonably requested by Aurizon Network in accordance with this Undertaking.

For clarification, **clauses 7.4.2, 7.4.3, 7.4.4, and 7.4.5 and 7.4.6** do not apply to Customer Initiated Transfers.

7.4.8 Relinquishments

- (a) If an Access Holder wishes to relinquish any of its Access Rights it must give Aurizon Network reasonable notice of its intention (**Notice of Intention to Relinquish**).
- (b) A Notice of Intention to Relinquish must specify:
 - (i) the Access Rights, by reference to each Train Service Type, which the Access Holder intends to relinquish (**Nominated Access Rights**); and
 - (ii) the date (**Relinquishment Date**) on which the Nominated Access Rights are to be relinquished (provided that such Relinquishment Date must not be more than two (2) Years after the date on which the Access Holder gives the Notice of Intention to Relinquish to Aurizon Network).
- (c) Nominated Access Rights the subject of a Notice of Intention to Relinquish will not be relinquished until the later of:
 - (i) the date upon which the Access Holder pays the Relinquishment Fee to Aurizon Network; and
 - (ii) the Relinquishment Date.
- (d) Subject to **clause 07A-5**, Aurizon Network must:
 - (i) calculate the fee payable to Aurizon Network in respect of the relinquishment of the Nominated Access Rights (**Relinquishment Fee**); and
 - (ii) notify the Access Holder of the amount of the Relinquishment Fee and how the Relinquishment Fee was calculated, including details of any assumptions made when calculating the Relinquishment Fee and reasons for those assumptions,

at the following times:
 - (iii) if the Access Holder is considering relinquishing some or all of the Access Rights but has not given Aurizon Network a Notice of Intention to Relinquish in respect of those Access

- Rights, promptly following a request by the Access Holder;
and
- (iv) if the Access Holder has given Aurizon Network a Notice of Intention to Relinquish, not less than five (5) Business Days before the Relinquishment Date.
- (e) Subject to **clause 7.4.8(f)**, the Relinquishment Fee is the amount calculated as follows:
- (i) for coal carrying Train Services included in a Pre-Approval Date Coal Access Agreement, in accordance with that Pre-Approval Date Coal Access Agreement; or
 - (ii) in all other cases, the amount equivalent to the present value, calculated at the Discount Rate, of the payment of the aggregate TOP Charges for the relevant Train Service Types that would have been payable for the remainder of the term of the relevant Access Agreement assuming:
 - (A) the Nominated Access Rights were not relinquished; and
 - (B) the relevant Train Services were not operated for the Access Holder for a reason other than Aurizon Network Cause,

(PV Amount) less the amount which is the product of the PV Amount and the greater of:

 - (C) 0.5; and
 - (D) the Reduction Factor.
- (f) Despite any other provision in this **clause 7.4.8**, if the Relinquishment Fee is calculated to be an amount that is less than zero, then the Relinquishment Fee will be zero.
- (g) Aurizon Network may, in accordance, and subject to compliance, with clause 11 of the Standard Access Agreement, reduce the number of Nominated Monthly Train Services of an Access Holder for a Train Service Type if, at a point in time, the Average Annual Payload for that Train Service Type operated by the Train Operator exceeds the Maximum Payload for that Train Service Type and the Access Holder fails to respond to a notice from Aurizon Network as required by clause 11 of the Standard Access Agreement.
- (h) Where the Nominated Monthly Train Services of an Access Holder are reduced by Aurizon Network as contemplated by **clause 7.4.8(g)**, Aurizon Network will notify the Train Operator(s) in accordance with the Standard Train Operations Deed(s) of any changes to the Nominated Monthly Operational Rights.

- (i) If an Access Holder wishes to increase the Maximum Payload for any of its Train Service Types which would result in that Access Holder holding Surplus Access Rights under its Access Agreement:
- (i) the Access Holder may with the consent of each relevant Customer of the Access Holder (if any) or the consent of each relevant Train Operator where the Access Holder is not also the Train Operator, give Aurizon Network a notice in accordance with the terms of clause 10 of the Standard Access Agreement specifying whether the Access Holder elects to relinquish or maintain the Surplus Access Rights for the relevant Train Service Type;
 - (ii) where the Access Holder elects to relinquish the Surplus Access Rights for the relevant Train Service Type, then, subject to compliance by each of the Access Holder and Aurizon Network with the terms of clause 10 of the Standard Access Agreement, including the payment of the SAR Relinquishment Fee by the Access Holder, (but for the avoidance of doubt, no other Relinquishment Fee), some or all of those Surplus Access Rights may be relinquished;
 - (iii) where the Access Holder elects to maintain the Surplus Access Rights for the relevant Train Service Type, then, subject to compliance by each of the Access Holder and Aurizon Network with the terms of clause 10 of the Standard Access Agreement, the Surplus Access Rights for the Train Service Type will continue to form part of the Access Rights held by the Access Holder; and
 - (iv) Aurizon Network will notify the Train Operator of any changes to:
 - (A) the Nominated Monthly Operational Rights;
 - (B) the Maximum Payload for the relevant Train Service Type;
 - (C) the Nominal Payload for the relevant Train Service Type; and
 - (D) the Indicative Tonnage for the relevant Train Service Type,as a result of the increase in the Maximum Payload for a Train Service Type in accordance with the Standard Train Operations Deed.
- (j) Where the Nominated Monthly Train Services of an Access Holder are reduced by Aurizon Network as contemplated by **clause 7.4.8(g)** a SAR Relinquishment Fee will be payable by the relevant Access Holder to Aurizon Network. For the avoidance of doubt, no other

Relinquishment Fee will be payable by the relevant Access Holder to Aurizon Network.

- (k) Promptly after the Commencing Date, Aurizon Network will notify all Access Holders with Access Agreements that provisions relating to payloads and relinquishments have been included in the Standard Access Agreement (being clauses 10, 11 and 13 of the Standard Access Agreement) and that, subject to receipt by Aurizon Network of a notice from an Access Holder under **clause 7.4.8(l)** it agrees to amend existing Access Agreements to include equivalent provisions.
- (l) Where, within 60 days after receiving a notice under **clause 7.4.8(k)**, an Access Holder notifies Aurizon Network that it wishes to amend the Access Holder's Access Agreement to include a provision that is in all material respects equivalent to clause 10, 11 and 13 of the Standard Access Agreement, Aurizon Network will prepare, and provide to the Access Holder, an appropriate variation agreement to the Access Agreement and, if executed by the Access Holder, execute that variation agreement.

7.4.9 General provisions

- (a) Aurizon Network must act in a diligent and timely manner in dealing with a proposed Transfer under **clause 7.4.2** or relinquishment under **clause 7.4.8**.
- (b) If the calculation of the Transfer Fee or Relinquishment Fee changes after the date of the notice under **clause 7.4.2(a)** or **clause 7.4.8(d)**, but before the Transferor or Access Holder (as applicable) (Payor) has paid the amount in the notice, then:
 - (i) Aurizon Network must advise the Payor of the revised amount and full reasons for the change in the calculation; and
 - (ii) the Payor must pay the revised amount, unless:
 - (A) it has already paid the amount in the notice; or
 - (B) the amount paid by the Payor is in excess of the revised amount, in which case Aurizon Network must refund the excess amount to the Payor or set it off against the next invoice (if any) payable by the Payor to Aurizon Network.
- (c) In calculating the Transfer Fee or Relinquishment Fee, Aurizon Network may assume that each of the Access Charge Rates (as at the Transfer Date or Relinquishment Date, as applicable) will escalate, on each 1 July, at the rate of 2.5% per annum for the remainder of the term of the relevant Access Agreement.
- (d) The Reduction Factor is the amount calculated as follows:
 - (i) if:

- (A) a new Access Holder or a Transferee has executed an Access Agreement (or a variation to an existing Access Agreement) in respect of Access Rights that Aurizon Network could not have provided without using the whole or part of the Nominated Access Rights; and
- (B) Aurizon Network's provision of the Access Rights under that Access Agreement commenced, for a new Access Holder:
 - (1) who is not a Transferee, after Aurizon Network was given the Notice of Intention to Relinquish, but prior to the payment to it of the Relinquishment Fee; or
 - (2) who is a Transferee, on and from the Transfer Date,

then:

- (C) for the purposes of **clauses 7.4.6(c)** and **7.4.8(e)(ii)**, if:
 - (1) the relevant Train Services of the existing Access Holder and of the new Access Holder or Transferee are coal carrying Train Services; and
 - (2) the Transferee's or new Access Holder's Train Services that will use the Nominated Access Rights will operate predominantly in and have a Nominated Unloading Facility in the same Coal System as the Train Services of the existing Access Holder that used those Nominated Access Rights,

an amount calculated as follows:

$$\text{TOPB} / \text{TOPA}$$

where:

TOPA is the amount equivalent to the present value, calculated at the Discount Rate, of the payment of the take or pay amount that would have been payable for the remainder of the term of the Access Agreement (**Remainder of the Original Term**) or for a Transfer, the take or pay amount that would have been payable for the Transfer Period if the Nominated Access Rights were not relinquished

but the existing Access Holder did not operate the relevant Train Services for a reason other than Aurizon Network Cause; and

TOPB is the amount equivalent to the present value, calculated at the Discount Rate, of the payment of the take or pay amount that would be payable in accordance with the new Access Holder's or Transferee's Access Agreement (in relation to the whole or part of the Nominated Access Rights) if the new Access Holder's or Transferee's Train Services using the Nominated Access Rights were not operated by or for the new Access Holder or Transferee during the same period as the Remainder of the Original Term or for a Transfer, the take or pay amount that would have been payable for the Transfer Period for a reason other than Aurizon Network Cause; or

(D) if: **clause 7.4.9(d)(i)(C)** does not apply, an amount calculated as follows:

A / B

where:

A is the annual train kilometres over the Common Corridor attributable to the new Access Holder's or Transferee's Train Services in respect of which Access Rights could not have been provided without using the whole or part of the Nominated Access Rights; and

B is the annual train kilometres over the Rail Infrastructure attributable to the Train Services operated under the Nominated Access Rights,

provided that to the extent that the new Access Holder's average contribution to Common Costs per train kilometre for its relevant Train Service is less than the existing Access Holder's average contribution to Common Costs per train kilometre for its

relevant Train Service, the Reduction Factor will be decreased in proportion to that relative contribution; and

- (ii) if **clause 7.4.9(d)(i)** does not apply, zero (0).
- (e) If the Reduction Factor is calculated in accordance with **clause 7.4.9(d)** and the Reference Tariff in relation to the Nominated Access Rights includes a System Discount or System Premium, then the Transfer Fee or Relinquishment Fee, as applicable, must be further adjusted by Aurizon Network to account for any consequential decrease or increase (as applicable) in the System Discount or System Premium (as applicable) that would otherwise result in Aurizon Network under-recovering or over-recovering (as applicable) amounts from the Access Holder due to the application of the System Discount or System Premium (as applicable).
- (f) Aurizon Network must maintain, on its Website, worked examples of the calculation of a Relinquishment Fee.
- (g) The Access Holder may dispute, in accordance with the dispute provisions under the Access Agreement, the calculation of the Transfer Fee or Relinquishment Fee notified by Aurizon Network to the Transferor or the Access Holder (as applicable) under **clause 7.4.6(b)(ii)** or **7.4.8(d)(ii)** (including any assumptions made by Aurizon Network).

7.5 Mutually Exclusive Access Applications

7.5.1 Notification and assistance

- (a) Aurizon Network will identify Access Applications that are or have become Mutually Exclusive Access Applications and will notify an Access Seeker as soon as practicable after Aurizon Network identifies that the Access Seeker's Access Application is or has become a Mutually Exclusive Access Application.
- (b) Aurizon Network will, if requested, provide reasonable assistance to an Access Seeker to identify whether its Access Application can be modified so that it is not a Mutually Exclusive Access Application.

7.5.2 Queuing mechanism

- (a) This **clause 7.5.2**:
 - (i) applies in respect of Mutually Exclusive Access Applications or where this Undertaking otherwise specifies that an Access Seeker has joined the Queue; and
 - (ii) does not apply to:
 - (A) an Access Application for Access Rights that can only be granted subject to an Expansion creating additional Available Capacity; or

- (B) in relation to the allocation of Available Capacity that:
 - (1) is subject to a Provisional Capacity Allocation under **Part 8** (including a Provisional Capacity Allocation arising from a reallocation under **Part 8**, for example under **clause 8.2.3(b)**);
 - (2) is or was subject to a Provisional Capacity Allocation that Aurizon Network, in accordance with **Part 8**, is seeking to reallocate following a withdrawal of that Provisional Capacity Allocation; or
 - (3) is or was subject to a Provisional Capacity Allocation in respect of which the relevant Access Seeker has entered into an Access Agreement, Access Conditions or User Funding Agreement relating to the corresponding Access Rights; or
 - (C) an Access Application for Access Rights which are sought according to a Transfer under **clause 7.4.2** or in accordance with the terms of an Access Agreement; or
 - (D) a Customer Initiated Transfer.
- (b) In allocating Available Capacity, Aurizon Network will prioritise Access Seekers in a chronological queue based on the date when Aurizon Network is deemed to have received each Access Seeker's Access Application as outlined in **clause 4.4(c) (Queue)**, except that:
- (i) a Renewing Access Seeker will be placed ahead of all other Access Seekers in the Queue in respect of the Access Rights the subject of the Renewal, but only to the extent that the Renewing Access Seeker complies with **clause 7.3(h)(ii)(C)**;
 - (ii) in respect of Conditional Access Rights where:
 - (A) relevant Access Holders have been notified in accordance with **clause 8.9.5(b)(i)** of its Reduced Conditional Access Rights; and
 - (B) an Access Application is deemed to have been lodged in respect of the reduction as a result of the Conditional Access Holder providing notice to Aurizon Network under **clause 8.9.3(a)(ii)** or **clause 8.9.4(d)(ii)**; and
 - (C) either:

- (1) there is Available Capacity which is capable of satisfying that Access Application in respect of the reduction; or
- (2) the Conditional Access Holder referred to in **clause 7.5.2(b)(ii)(B)** is, in Aurizon Network's reasonable opinion, diligently pursuing the study and development of the relevant Expansion,

then:

- (D) the Conditional Access Holder and Affected Access Holder (as applicable) will be given priority in the Queue behind any Renewals in respect of the Access Application for that reduction; and
 - (E) where there are two (2) or more Conditional Access Holders or Affected Access Holders (as applicable) affected, each Conditional Access Holder and Affected Access Holder (as applicable) will be treated as having the same position in the Queue for the purpose of negotiating and allocating the Available Capacity.
- (c) Access Applications to be included in the Queue that are Competing Applications will be collectively positioned in the Queue in accordance with **clause 7.5.2(b)** as though they were a single application received by Aurizon Network, for the purposes of the Queue, at the time the earliest of the Competing Applications was deemed to be received by Aurizon Network.
- (d) An Access Seeker will be removed from the Queue if:
- (i) the Access Seeker's Access Application has been withdrawn or the Negotiation Period for an Access Seeker has ceased in accordance with **Part 4**;
 - (ii) Aurizon Network has determined not to allocate Available Capacity to an Access Seeker as a result of the operation of **clause 7.2.1**;
 - (iii) the Access Seeker is a Conditional Access Holder and it has not provided notice to Aurizon Network under **clause 8.9.3(a)(ii)** or **clause 8.9.4(d)(ii)**; or
 - (iv) the Access Seeker is a Conditional Access Holder that has provided notice to Aurizon Network under **clause 8.9.3(a)(ii)** or **clause 8.9.4(d)(ii)** but, in Aurizon Network's reasonable opinion, is not diligently pursuing the study and development of the relevant Expansion.
- (e) Aurizon Network must promptly notify:

- (i) following receipt of a notification of intent from an Access Seeker under **clause 4.7**, that Access Seeker of the initial position of their Access Application in the Queue; and
- (ii) thereafter, of any change to that position in the Queue and the reason(s) for that change.

(For clarity, the timing of Aurizon Network's notification under **clause 7.5.2(e)(i)** does not affect the position of an Access Seeker's Access Application in the Queue).

- (f) An Access Seeker may assign its position in the Queue to another party who:
 - (i) is a Railway Operator and the Access Seeker has entered into an agreement with that Railway Operator to provide the Train Services and requires that Railway Operator to hold the Access Rights;
 - (ii) is a Related Party of the Access Seeker and the assignment is not a Material Variation; or
 - (iii) has acquired the whole or a substantial part of the assets of the Access Seeker.
- (g) If a dispute concerning positions in the Queue or any other aspect of Aurizon Network's management of the Queue is referred for resolution under **Part 11**, Aurizon Network must not change an Access Seeker's position in that Queue unless and until that Dispute is resolved in favour of such a change in position.

7.5.3 Mutually Exclusive Access Application

- (a) If Aurizon Network has received Mutually Exclusive Access Applications for Available Capacity, then Aurizon Network will enter into negotiations for Access Agreements (including any agreements to allow Access Rights to be exercised or created – for example, a Rail Connection Agreement) for the Available Capacity for those Access Applications that meet the requirements of **Part 4**.
- (b) Subject to the terms of this Undertaking and for the purposes of **clause 7.5.2(b)**, in allocating Available Capacity, Aurizon Network may offer that Available Capacity simultaneously to each Access Seeker in the Queue who has an Access Application for Access Rights that correspond with the Available Capacity, which offer must specify:
 - (i) the position in the Queue of the relevant Access Seeker's Access Application in comparison to all other Access Seekers in the Queue who have been simultaneously offered the Available Capacity;
 - (ii) the timeframe in which the relevant Access Seeker may notify Aurizon Network that it wishes to accept the offer of

- allocation of all or part of the Available Capacity being offered; and
- (iii) if applicable, that the offer is subject to other Access Seekers having Access Applications for Access Rights that correspond with the Available Capacity ahead of the relevant Access Seeker in the Queue being allocated the Available Capacity; and
 - (iv) that the offer is subject to the Access Seeker executing an Access Agreement within 20 Business Days of it accepting the offer in accordance with **clause 7.5.3(b)(ii)**.
- (c) Where Aurizon Network has allocated Available Capacity under this **clause 7.5.3** and none of the remaining Access Seekers can be granted the Access Rights sought as there is insufficient Available Capacity to do so, then negotiations with those remaining Access Seekers are suspended and **clause 4.8** will apply.

7.6 Capacity resumption

- (a) If an Access Holder for any reason other than the occurrence of a Force Majeure Event or an Aurizon Network Cause does not:
 - (i) for Cyclic Traffic, cause the operation of at least eighty five percent (85%) of the Train Services allowed under the Access Holder's Train Service Entitlement over a period of four (4) consecutive Quarters; or
 - (ii) for Timetabled Traffic, cause the operation of a Train Service on a Scheduled Train Path seven (7) or more (not necessarily consecutive) times out of any twelve (12) consecutive occasions on which that particular Scheduled Train Path exists,

(Resumption Trigger Event) Aurizon Network may provided that the Access Holder's failure to meet the thresholds referred to in **clauses 7.6(a)(i) or 7.6(a)(ii)** (as applicable) is not the result of an Existing Capacity Deficit, within forty (40) Business Days after the Resumption Trigger Event, give that Access Holder notice (**Information Request Notice**) which includes:

- (iii) reasonable details of the Resumption Trigger Event;
- (iv) the Access Rights for the Train Service Type which Aurizon Network considers to be underutilised Access Rights for the Train Service Type in respect of the Resumption Trigger Event;
- (v) that Aurizon Network is considering resuming the whole or part of the underutilised Access Rights for the Train Service Type to the extent of that underutilisation;

- (vi) requesting the Access Holder to demonstrate a sustained requirement for the underutilised Access Rights; and
- (vii) reasonable details of Aurizon Network's reasonable expectation of a sustained alternative demand for the Capacity used by the Access Rights in question.

For clarity:

- (viii) nothing in this **clause 7.6(a)** requires Aurizon Network to disclose any information that is not relevant to the Information Request Notice in respect of the Resumption Trigger Event or information that is commercially sensitive to the Aurizon Group; and
 - (ix) Aurizon Network will not be in breach of its obligations under **Part 3** when making a disclosure under this **clause 7.6(a)** provided that the information disclosed is relevant to the resumption in question.
- (b) Aurizon Network must not give an Information Request Notice in respect of a Resumption Trigger Event for a Train Service Type specified in **clause 7.6(a)** more than forty (40) Business Days after the end of the applicable four (4) consecutive Quarters referred to in **clause 7.6(a)**.
 - (c) If Aurizon Network gives an Access Holder an Information Request Notice within the timeframe set out in **clause 7.6(a)**, the Access Holder must:
 - (i) within fifteen (15) Business Days after Aurizon Network gives the Information Request Notice to the Access Holder, provide to Aurizon Network the information requested in the Information Request Notice; and
 - (ii) if required by Aurizon Network, meet with Aurizon Network to discuss the suspected Resumption Trigger Event for the applicable Train Service Type.
 - (d) If an Information Request Notice is given to an Access Holder and:
 - (i) the Access Holder has not demonstrated, to Aurizon Network's reasonable satisfaction, a sustained requirement for the Access Rights that were not utilised; and
 - (ii) Aurizon Network has demonstrated that it has a reasonable expectation of a sustained alternative demand for the Capacity used by the Access Rights in question,

then Aurizon Network may give a further notice (**Resumption Notice**) confirming the Resumption Date and that it will reduce that Access Holder's Access Rights from the Resumption Date by:

- (iii) for Cyclic Traffic, reducing the Access Holder's Access Rights to the extent that the Access Holder's Train Service Entitlement was underutilised; or
 - (iv) for Timetabled Traffic, deleting the Scheduled Train Path referred to in **clause 7.6(a)(ii)** from the Access Holder's Train Service Entitlement.
- (e) A Resumption Notice must:
- (i) not be given before the end and not more than twenty (20) Business Days after the end of the fifteen (15) Business Day period in **clause 7.6(c)(i)**; and
 - (ii) specify:
 - (A) full details of the Access Rights for the Train Service Type to be resumed (**Resumed Access Rights**); and
 - (B) the date on which the resumption will take effect (which must be at least ten (10) Business Days after the Resumption Notice is given to the Access Holder) (**Resumption Date**).
- (f) If a valid Resumption Notice is given under this **clause 7.6**, the underutilised Access Rights for the Train Service Type will cease to form part of the Access Rights for the Train Service Type on and from the Resumption Date (other than for the purpose of calculating any TOP Charges that are payable as a result of the non-utilisation of any of the Resumed Access Rights prior to the Resumption Date).
- (g) Aurizon Network may withdraw a Resumption Notice prior to the later of the Resumption Date and fourteen (14) days after the determination of any dispute in relation to the Resumption Notice.
- (h) If Aurizon Network resumes an Access Holder's Access Rights in accordance with this **clause 7.6**, then the Access Charge payable by the Access Holder will be varied in accordance with the terms of the relevant Access Agreement and the Access Agreement will be varied accordingly.
- (i) If there is a dispute in connection with a decision by Aurizon Network to:
- (i) issue an Information Request Notice and the Access Holder considers that Aurizon Network had insufficient grounds to do so under **clause 7.6(a)**; and
 - (ii) resume an Access Holder's Access Rights in accordance with this **clause 7.6**,

then Aurizon Network must not implement the resumption until the dispute resolution process has been concluded, and then only to the

extent that such resumption is consistent with the outcomes of the dispute resolution process.

Part 7A: Capacity

7A.1 Intent

- (a) The purpose of this **Part 7A** is to provide for the independent and realistic assessment of:
- (i) the **Deliverable Network Capacity** of the Rail Infrastructure in each Coal System; and
 - (ii) separately, the **System Capacity** of each Coal System,
- having regard to the way in which that Coal System operates in practice (and in the context of the interfaces between each element of the Supply Chains within that Coal System) and making allowances that reflect operational parameters.
- (b) In particular:
- (i) **clause 7A.2** provides definitions for Deliverable Network Capacity and System Capacity that have contextual regard to interfaces between the operation of the Rail Infrastructure and the other facilities forming part of the Supply Chains in the relevant Coal System;
 - (ii) **clause 7A.3** describes the procedure by which an Independent Expert will be appointed to perform Capacity Assessments;
 - (iii) **clause 7A.4** describes the procedure by which the Independent Expert will conduct the IE Initial Capacity Assessment, Annual Capacity Assessments and System Capacity Assessments. It also outlines the procedure by which the Independent Expert reports on its Capacity Assessments to the QCA and stakeholders;
 - (iv) **clause 7A.5** describes the process which Aurizon Network must follow where the IE Initial Capacity Assessment reveals an Existing Capacity Deficit in relation to the Coal System; and
 - (v) **clause 7A.6** describes the process by which the Independent Expert will assess and administer any Rebate payable by Aurizon Network to End Users.

7A.2 Definition of Deliverable Network Capacity and System Capacity

- (a) For the purpose of this **Part 7A**, **Deliverable Network Capacity** means the capacity of the Rail Infrastructure, expressed as the maximum number of Train Paths (calculated on a Monthly and annual basis) that can be utilised in each Coal System (such Train Paths needing to be useable including in respect of return journeys), and the

mainline and each branch line of that Coal System, taking into account the operation of that Coal System, having regard to:

- (i) the way in which the relevant Coal System operates in practice, including those matters taken into consideration in formulating the System Operating Parameters;
 - (ii) reasonable requirements in respect of planned maintenance and a reasonable estimate of unplanned maintenance, repair, renewal and Expansion activities on the Rail Infrastructure;
 - (iii) reasonably foreseeable delays or failures of Rollingstock occurring in the relevant Supply Chain, both planned delays and failures and a reasonable estimate of unplanned delays and failures;
 - (iv) reasonably foreseeable delays associated with any restrictions (including speed restrictions, dwell times within Train Services and between Train Services and other operating restrictions) affecting the Rail Infrastructure;
 - (v) the context in which the Rail Infrastructure interfaces with other facilities forming part of, or affecting, the relevant Supply Chain (including loading facilities, load out facilities and coal export terminal facilities);
 - (vi) the need for Aurizon Network to comply with its obligations to provide access to non-coal traffic under Access Agreements, Passenger Priority Obligation or Preserved Train Path Obligations;
 - (vii) the Supply Chain operating mode (including at the loading facilities, load out facilities and coal export terminal facilities);
 - (viii) interfaces between the different Coal Systems; and
 - (ix) the terms of Access Agreements (including the number of Train Service Entitlements for each origin and destination combination in that Coal System) relating to Train Services operating in that Coal System.
- (b) For the purpose of this **Part 7A, System Capacity** means the capacity of the Supply Chain in its entirety, including the maximum number of Train Paths (calculated on a Monthly and annual basis) that can be utilised in each Coal System, and the mainline and each branch line of that Coal System, taking into account the operation of that Coal System, having regard to:
- (i) each of the items contained in **clauses 7A.2(a)(i) - (ix)** of the definition of Deliverable Network Capacity; and
 - (ii) the capacity and operations of each element of the Supply Chain (including loading facilities, load out facilities and coal

export terminal facilities) and interfaces between the different Coal Systems.

7A.3 Engagement of Independent Expert

7A.3.1 *Appointment of Independent Expert*

- (a) Aurizon Network and a Special Majority of End Users will use their best endeavours to jointly appoint an Independent Expert, which expert will be responsible for, amongst other things:
 - (i) conducting Capacity Assessments in accordance with this **Part 7A** (which includes developing and amending the System Operating Parameters);
 - (ii) reviewing performance information including source data received from Aurizon Network, Access Holders and other Supply Chain Participants for the purpose of the Independent Expert's reporting obligations under **clause 10.8.3**;
 - (iii) reporting on actual performance data and maintenance information to the QCA, Aurizon Network and relevant stakeholders for the purpose of the Independent Expert's reporting obligations under **clause 10.8.3**; and
 - (iv) determining any Rebate payable by Aurizon Network to End Users in accordance with **clause 7A.6**.
- (b) Subject to **clause 7A.3.3**, the Independent Expert's appointment under this **clause 7A.3.1** expires at the completion of the Term or such later time as may be specified in the contract of appointment.
- (c) If at any time during the Term, no Independent Expert is appointed (for example due to the resignation or termination of the Independent Expert), the members of the Rail Industry Group and Aurizon Network must consult with each other and Aurizon Network and a Special Majority of End Users must seek to agree on the appointment of a new independent expert on terms substantially similar in all material respects to the terms of the appointment of the previous independent expert (or such other terms agreed).
- (d) If a Special Majority of End Users and Aurizon Network cannot agree on:
 - (i) the appointment of the Independent Expert by the date that is 30 days after the Approval Date; or
 - (ii) a new independent expert under **clause 7A.3.1(c)** within within 30 days of the cessation of the previous appointment,the appointment of the Independent Expert under this **Part 7A** must be referred for resolution as a Dispute under **clause 11.1.1(a)(iii)** of this Undertaking.

- (e) On the resolution of the dispute under **clause (d)** Aurizon Network and a Special Majority of End Users will use their best endeavours to jointly appoint an Independent Expert to fulfil the obligations as set out in this Undertaking and on the terms provided for in this **Part 7A**.
- (f) The Independent Expert appointed under **clauses 7A.3.1(a)** or, **7A.3.1(c)** must:
 - (i) be independent and impartial;
 - (ii) engage personnel with appropriate qualifications and practical experience having regard to the nature of the appointment (including qualifications and experience in modelling the capacity of coal chain infrastructure) provided that if the Independent Expert is a new entity, this requirement will be satisfied where the employees and personnel of the new entity are appropriately qualified and experienced;
 - (iii) have no interest or duty which conflicts or may conflict with their function as an Independent Expert, or where it believes it has such an interest or duty, the Independent Expert must fully disclose that interest or duty by notice to the members of the Rail Industry Group, Aurizon Network and the QCA prior to their appointment; and
 - (iv) be required to manage the confidential nature of all information and matters coming to their knowledge by reason of their appointment and performance of their duties including in accordance with the terms of any confidentiality agreement in favour of Aurizon Network and if requested, any other entity providing information under this **Part 7A**.

7A.3.2 [Not used]

7A.3.3 Termination of engagement of Independent Expert

- (a) On the date that is four (4) years after the Approval Date, the QCA must review the appointment of the Independent Expert.
- (b) Following this review:
 - (i) Aurizon Network and a Special Majority of End Users may agree; or
 - (ii) the QCA may, in its absolute discretion, elect,
to terminate the engagement of the Independent Expert and appoint a replacement independent expert in accordance with this **Part 7A**.
- (c) The Independent Expert's contract of appointment must include provisions enabling termination of the appointment of the Independent Expert as follows:
 - (i) if, at any time, the Independent Expert is in default of its obligations under the contract of appointment, either the

Chair of the Rail Industry Group (on behalf of the Special Majority of End Users) or Aurizon Network (as applicable) may provide a written termination notice to the Independent Expert (with a copy to the other party) in accordance with the terms of that contract; or

- (ii) if, at any time, the Chair of the Rail Industry Group (on behalf of the Special Majority of End Users) and Aurizon Network mutually agree to terminate the appointment of the Independent Expert, both the Chair of the Rail Industry Group (on behalf of the Special Majority of End Users) and Aurizon Network may provide a written termination notice to the Independent Expert in accordance with the terms of that contract.
- (iii) if the QCA elects to terminate the appointment under **clause (b)(ii)** or **clause (e)(iii)**.

Any party who issues a written notice of termination under this **clause 7A.3.3(c)** must also promptly provide a copy of that notice to the QCA.

- (d) If, at any time during the term of their appointment, the Independent Expert becomes aware of any circumstances that might reasonably be considered to adversely affect the Independent Expert's ability to act independently or impartially, the Independent Expert must notify the QCA immediately in writing.
- (e) Upon receiving a notice under **clause 7A.3.3(d)**, or if the QCA otherwise becomes aware of any circumstances that might be considered to adversely affect the Independent Expert's ability to act independently and impartially (including if the QCA has received a notice from any stakeholders to this effect) the QCA must promptly:
 - (i) notify the Chair of the Rail Industry Group and Aurizon Network of its receipt of any notice received under **clause 7A.3.3(d)**;
 - (ii) consider, on the basis of the notice and other information reasonably available to the QCA (including any information provided by the Chair of the Rail Industry Group or Aurizon Network), whether the circumstances would likely affect the ability of the Independent Expert to act independently or impartially; and
 - (iii) terminate the engagement of the Independent Expert if it considers the ability of the Independent Expert to act independently or impartially has been, or is likely to be, affected (in its absolute discretion),

in which case a new Independent Expert must be appointed in accordance with the procedure outlined in this **clause 7A.3**.

7A.3.4 Costs

- (a) The Independent Expert's costs of performing its role will be a pass through cost recoverable as a component of the Reference Tariff by which Access Charges are calculated (**IE Pass Through Cost**).
- (b) The IE Pass Through Cost will be based on the forecast provided by the Independent Expert under **clause 7A.3.4(c)** and will not be part of Aurizon Network's Allowable Revenue.
- (c) With effect from 14 February 2020, by 14 February of each Year, the Independent Expert will notify Aurizon Network (in writing) of its forecast IE Pass Through Cost for the next Year (including details of any adjustments made by the Independent Expert in calculating the forecast as a result of any over or under recovery of the Independent Expert's costs (if any) in the previous Year and an estimate in respect of the balance of the Year in which the forecast is being provided).
- (d) Any under recovery of the Independent Expert's costs in respect of the Year ending 30 June 2020 will be the subject of an adjustment by the Independent Expert when advising the IE Pass Through Cost for 2021.
- (e) Aurizon Network will calculate the IE Fee component of Access Charges for each Access Holder on a \$ per net tonne basis, which will be payable by Access Holders in their Monthly invoices.
- (f) With effect from 28 February 2020, by 28 February of each Year Aurizon Network will notify the QCA of the forecast IE Pass Through Cost advised by the Independent Expert under **clause 7A.3.4(c)** as part of its submission on the annual review of Reference Tariffs under **clause 4.1 of Schedule F**.
- (g) In the event that the Independent Expert has not advised Aurizon Network of the forecast IE Pass Through Cost for the Year ending 30 June 2021 by 14 February 2020, the Independent Expert will advise Aurizon Network of the forecast IE Pass Through Cost for 2021 as soon as it is known and Aurizon Network will notify the QCA of that forecast IE Pass Through Cost which will constitute an Endorsed Variation Event under **clause Schedule F5.2(d) of Schedule F**.

7A.3.5 Appointment of initial Independent Expert

For the purpose of appointing the initial Independent Expert under **clause 7A.3.1(a)**, a determination as to whether the thresholds in the definition of a "Special Majority of End Users" have been met will be made by Aurizon Network.

7A.4 Capacity Assessments by Independent Expert

7A.4.1 IE Initial Capacity Assessment

- (a) As soon as reasonably practicable and by no later than ten (10) Business Days after its appointment, the Independent Expert must

commence its initial assessment of the Deliverable Network Capacity of each Coal System for the Capacity Assessment Period in accordance with the procedure outlined in this **clause 7A.4.1 (IE Initial Capacity Assessment)**.

(b) As part of the IE Initial Capacity Assessment, the Independent Expert must develop the System Operating Parameters for each Coal System having regard to the way in which each Coal System operates in practice. The Independent Expert must seek to ensure that the System Operating Parameters:

- (i) include a consideration of the factors set out in the definition of **Deliverable Network Capacity** as such factors apply as at the date the System Operating Parameters are developed; and
- (ii) would not place Aurizon Network in breach of its obligations under this Undertaking or any Access Agreement (assuming that any Access Agreement could be amended to reflect the System Operating Parameters in accordance with **clause 7A.12**),

having regard to (among other things) the information received from Aurizon Network and Access Holders and Access Seekers (and their Customers and Train Operators, as applicable).

(c) The Independent Expert must seek to consult with, and seek submissions from, Aurizon Network, Access Holders and Access Seekers (and their Customers and Train Operators, as applicable) and all Supply Chain Participants for each Coal System on:

- (i) subject to any confidentiality restrictions, information that relates to the operation of Train Services in that Coal System and the actual performance of that Coal System for the purpose of the IE Initial Capacity Assessment (including the development of the dynamic model required to undertake the Deliverable Network Capacity Analysis); and
- (ii) the proposed System Operating Parameters,

and the Independent Expert will seek to obtain such information from Supply Chain Participants by the date the earlier of the date that is 2 months after the appointment of the Independent Expert or the Approval Date.

(d) Aurizon Network must promptly do everything reasonably requested by the Independent Expert to assist the Independent Expert in carrying out an IE Initial Capacity Assessment under this **clause 7A.4.1**, including providing or making available to the Independent Expert, as soon as reasonably practicable, all information and materials in its possession or control relevant to those matters listed in the definition of Deliverable Network Capacity and otherwise requested by the Independent Expert by the earlier of the date that is

2 months after the appointment of the Independent Expert or the Approval Date, which may include, subject to the relevant Access Holders and Customers providing consent to Aurizon Network disclosing information relevant to their Access Agreements:

- (i) copies of any Access Agreements entered into by Aurizon Network;
 - (ii) the System Rules;
 - (iii) Possession Protocols;
 - (iv) Rollingstock Interface Standard;
 - (v) Approved Derogations;
 - (vi) Aurizon Network's internal modelling of the Capacity of each Coal System (including access to the relevant models);
 - (vii) Aurizon Network's Maintenance Strategy and Budget, Renewals Strategy and Budget and operational plans; and
 - (viii) actual performance information (including all source and underlying information and data) for each Coal System for at least the previous three years, or such longer period as reasonably requested by the Independent Expert and in respect of which the information is readily available in the form requested.
- (e) The members of the Rail Industry Group must provide to the Independent Expert, and the Independent Expert must consider, any information it has in its possession or control in relation those matters listed in the definition of Deliverable Network Capacity by the earlier of the date that is 2 months after the appointment of the Independent Expert or the Approval Date and as otherwise requested by the Independent Expert.
- (f) The IE Initial Capacity Assessment must:
- (i) include a dynamic Deliverable Network Capacity Analysis based on a dynamic model developed by the Independent Expert (to be owned by the Independent Expert) that reflects how each Coal System operates in practice (having regard to the information received from Aurizon Network and Access Holders and Access Seekers (and their Customers and Train Operators, as applicable)) to determine the Deliverable Network Capacity for each Coal System. Subject to any confidentiality and intellectual property restrictions, the Independent Expert must provide a copy of the dynamic model developed by the Independent Expert to Aurizon Network and the QCA in a non-hard coded form for use by Aurizon Network and the QCA for internal purposes only;

- (ii) set out the System Operating Parameters for that Coal System as determined by the Independent Expert in accordance with **clause 7A.4.1(b)**;
- (iii) include consideration of:
 - (A) outcomes of any consultation by the Independent Expert with Aurizon Network, Access Holders and Access Seekers (and their Customers and Train Operators, as applicable) and any other Supply Chain Participants for each Coal System in relation to that assessment;
 - (B) any information received from Aurizon Network under **clause 7A.4.1(d)**; and
 - (C) any information received from the members of the Rail Industry Group under **clause 7A.4.1(e)**.
- (iv) include a report that sets out:
 - (A) the Independent Expert's assumptions affecting Deliverable Network Capacity and relied upon for the IE Initial Capacity Assessment which:
 - (1) must address each of the assumptions contained in the definition of Deliverable Network Capacity and the System Operating Parameters, and used to develop the model required to undertake the Deliverable Network Capacity Analysis; and
 - (2) may include such other assumptions as are reasonably considered relevant by the Independent Expert to its assessment of Deliverable Network Capacity and relied upon for the IE Initial Capacity Assessment in its absolute discretion (including any assumptions regarding Rollingstock, section run times and loading and unloading times);
 - (B) any constraints the Independent Expert has identified which have reduced or are likely to reduce the Deliverable Network Capacity of each Coal System, including:
 - (1) any constraints identified within the Supply Chains operating within that Coal System (including in respect of loading facilities, load out facilities and coal export terminal facilities); and
 - (2) any constraints identified within the whole of the Rail Infrastructure; and

- (C) if the Independent Expert identifies in the IE Initial Capacity Assessment that there is an Existing Capacity Deficit with respect to a Coal System:
 - (1) specify the relevant Coal System and the location in that Coal System where the Existing Capacity Deficit arises; and
 - (2) specify the quantum of the Existing Capacity Deficit;
 - (v) if the Independent Expert identifies a specific cause or causes of the Existing Capacity Deficit:
 - (A) specify the Access Holders affected by the Existing Capacity Deficit; and
 - (B) include in reasonable detail, solutions which could effectively and efficiently address the Existing Capacity Deficit.
- (g) As soon as reasonably practicable (it being acknowledged that the Independent Expert will be engaged on terms that require the Independent Expert to use its best endeavours and Aurizon Network and the members of the Rail Industry Group to act in good faith to enable the Independent Expert to undertake the IE Initial Capacity Assessment as quickly as is reasonably possible having regard to the nature of the assessment and the need to undertake an assessment that is both realistic and accurate), the Independent Expert must make:
 - (i) the outcomes of the IE Initial Capacity Assessment, including its assumptions affecting Deliverable Network Capacity and relied upon for the IE Initial Capacity Assessment (**Initial Capacity Assessment Report**); and
 - (ii) the System Operating Parameters,

available to Aurizon Network, and the QCA on an unredacted basis and to the Chair of the Rail Industry Group on a redacted basis.
- (h) Subject to **clause 7A.4.1(i)**, Aurizon Network and the QCA must promptly publish on the Website or its website (as applicable):
 - (i) the Initial Capacity Assessment Report in a redacted form that does not disclose information that is confidential to an Access Holder, Customer or Train Operator and unable to be disclosed; and
 - (ii) the System Operating Parameters of each Coal System.
- (i) An Access Holder, Customer or Train Operator may provide its prior written consent to Aurizon Network and the QCA for its confidential information to be disclosed in the Initial Capacity Assessment Report on an unredacted basis.

7A.4.2 Annual Capacity Assessment

- (a) The Independent Expert must undertake an annual assessment of the Deliverable Network Capacity of each Coal System for the relevant Capacity Assessment Period (each being an **Annual Capacity Assessment**). The first Annual Capacity Assessment will be undertaken for the first Year after the Initial Capacity Assessment Report has been completed.
- (b) As part of each Annual Capacity Assessment, the Independent Expert must:
 - (i) review the System Operating Parameters for that Coal System; and
 - (ii) consider whether any variation of the System Operating Parameters is required, provided that any amendments to the System Operating Parameters:
 - (A) include a consideration of the factors set out in the definition of **Deliverable Network Capacity**;
 - (B) would be consistent with the applicable Approved Maintenance Strategy and Budget and Renewals Strategy and Budget; and
 - (C) would not place Aurizon Network in breach of its obligations under this Undertaking or any Access Agreement (assuming that any Access Agreement could be amended to reflect the System Operating Parameters in accordance with **clause 7A.12**).
- (c) The Independent Expert must seek to consult with, and seek submissions from, Aurizon Network, Access Holders and Access Seekers (and their Customers and Train Operators, as applicable) and all other Supply Chain Participants for each Coal System on:
 - (i) any information that relates to the operation of Train Services in that Coal System for the purpose of the Annual Capacity Assessment; and
 - (ii) the proposed, and any variation of, the System Operating Parameters (as applicable).
- (d) The Independent Expert must promptly make:
 - (i) the outcomes of its Annual Capacity Assessment, including its assumptions affecting Deliverable Network Capacity and relied upon for the Annual Capacity Assessment (**Annual Capacity Assessment Report**); and
 - (ii) the current System Operating Parameters, available to Aurizon Network and the QCA on an unredacted basis.

- (e) For the purpose of this **clause 7A.4.2**, each of the obligations listed in **clauses 7A.4.1(d) – 7A.4.1(f)** and **clauses 7A.4.1(h) – 7A.4.1(i)** apply as if they were duplicated here, except that:
- (i) each reference to an IE Initial Capacity Assessment will be a reference to an Annual Capacity Assessment;
 - (ii) each reference to an Initial Capacity Assessment Report will be a reference to an Annual Capacity Assessment Report; and
 - (iii) each reference to “the earlier of the date that is 2 months after the appointment of the Independent Expert or the Approval Date” will be a reference to the “within the timeframe requested by the Independent Expert”.

7A.4.3 System Capacity Assessments

- (a) The Independent Expert must undertake a System Capacity Assessment for each Coal System as soon as reasonably practicable after the date that the Independent Expert publishes its Initial Capacity Assessment Report and thereafter on each anniversary thereof. It is acknowledged that the initial System Capacity Assessment should not delay the Independent Expert in undertaking the IE Initial Capacity Assessment in accordance with this **Part 7A**.
- (b) A System Capacity Assessment will be produced by the Independent Expert for information purposes only for the benefit of Aurizon Network, Access Holders and Access Seekers (and their respective Customers and Train Operators) for a Coal System and a copy of that report will be provided by the Independent Expert to Aurizon Network, the Chair of the Rail Industry Group and the members of the Rail Industry Group on a redacted basis.
- (c) Aurizon Network must promptly do everything reasonably requested by the Independent Expert to assist the Independent Expert in carrying out a System Capacity Assessment under this **clause 7A.4.3**, including providing or making available to the Independent Expert, as soon as reasonably practicable and subject to any confidentiality restrictions, all information and materials in its possession or control relevant to those matters listed in the definition of System Capacity and as otherwise requested by the Independent Expert, which may include, subject to the relevant Access Holders and Customers providing consent to Aurizon Network to disclose information relevant to their Access Agreements:
 - (i) copies of any Access Agreements entered into by Aurizon Network;
 - (ii) the System Rules;
 - (iii) Possession Protocols;
 - (iv) Rollingstock Interface Standard;

- (v) Approved Derogations;
 - (vi) Aurizon Network's internal modelling of the Capacity of each Coal System (including access to the relevant models);
 - (vii) Aurizon Network's Approved Maintenance Strategy and Budget, Renewals Strategy and Budget and operational plans; and
 - (viii) actual performance information (including all source and underlying information and data) for each Coal System for at least the previous three years, or such longer period as reasonably requested by the Independent Expert and in respect of which the information is readily available in the form requested.
- (d) Access Holders and Customers must provide to the Independent Expert, and the Independent Expert must consider, any information it has in its possession or control in relation those matters listed in the definition of System Capacity and as otherwise requested by the Independent Expert.
- (e) A System Capacity Assessment must include:
- (i) consideration of outcomes of any consultation by the Independent Expert with Aurizon Network, Access Holders and Access Seekers (and their Customer and Train Operator, as applicable) for Train Services operating in that Coal System;
 - (ii) consideration of outcomes of any consultation with any Supply Chain Group for the relevant Coal System;
 - (iii) consideration of outcomes of any consultation with port operators; and
 - (iv) a report that sets out the Independent Expert's assumptions affecting System Capacity and relied upon for the System Capacity Assessment which must be consistent with those assumptions listed in the definition of **System Capacity** and may include such other assumptions as are reasonably considered relevant by the Independent Expert to its assessment of System Capacity and relied upon for the System Capacity Assessment.
- (f) Nothing in this Undertaking:
- (i) obliges Aurizon Network to implement any changes to its provision of Access as a result of any System Capacity Assessment; or
 - (ii) allows the Independent Expert to alter the IE Initial Capacity Assessment or any Annual Capacity Assessment as a result of the System Capacity Assessment.

7A.4.4 Capacity Assessments to be final and binding

- (a) In the absence of fraud or manifest error, the Independent Expert's Capacity Assessment is final and binding.
- (b) If any person reasonably affected by the outcome of a Capacity Assessment believes that there has been a manifest error or fraud in the Capacity Assessment (or in its preparation), or that the Independent Expert has not complied with or satisfied the requirements of **clause 7A.3.1(f)**, it may refer the matter to the QCA for a determination.
- (c) If the QCA determines that there has been a manifest error or fraud or that the Independent Expert has not complied with or satisfied the requirements of **clause 7A.3.1(f)**, the Capacity Assessment is not final and binding and the Independent Expert must promptly commence a new Capacity Assessment in accordance with this **Part 7A**.
- (d) Subject to **clause 7A.4.4(f)**, at all times after the Initial Capacity Assessment Report is published by the QCA on its website as contemplated by **clause 7A.4.1(h)**, where Aurizon Network is required to have regard to Capacity in performing any of its obligations under this Undertaking (including in relation to the provision of Access), Aurizon Network must only have regard to the most recent Capacity Assessment undertaken by the Independent Expert or other information provided by the Independent Expert as expressly contemplated in the Undertaking (other than in the case of an IE Initial Capacity Assessment) and must not, for the avoidance of doubt, have regard to any of Aurizon Network's internal modelling of the Capacity of the relevant Coal System or any other form of Capacity modelling.
- (e) For the avoidance of doubt, any determination by the Independent Expert of the System Capacity is provided for information purposes only.
- (f) Aurizon Network and an Access Seeker (and Train Operator as applicable) may, acting reasonably and in good faith, negotiate Access Agreements and Train Operations Deeds for non-coal carrying Train Services that do not reflect the System Operating Parameters, and for the purposes of engaging in such negotiations Aurizon Network will not be bound by the System Operating Parameters which are developed by the Independent Expert as part of a Capacity Assessment referred to in **clause 7A.4.4(d)**.

7A.5 Existing Capacity Deficit

- (a) If the IE Initial Capacity Assessment reveals a Deliverable Network Capacity Shortfall in a relevant Coal System (**Existing Capacity Deficit**), Aurizon Network must:
 - (i) within twenty (20) Business Days after the Initial Capacity Assessment Report has been published by the QCA on its website, submit a preliminary report to the QCA (and publish such preliminary report in a prominent place on the Website) setting out:
 - (A) Aurizon Network's consultation plan (which, when followed, must satisfy the requirements of **clause 7A.5(a)(ii)**); and
 - (B) Aurizon Network's preliminary views on:
 - (1) the cause or causes of the Existing Capacity Deficit (including a response, in reasonable detail, to the cause or causes identified by the Independent Expert); and
 - (2) solutions which could most effectively (including cost effectively) and efficiently address the Existing Capacity Deficit (including a response, in reasonable detail, to the solutions identified by the Independent Expert); and
 - (3) the indicative timeframe within which it considers each of the solutions could reasonably be implemented;
 - (ii) prior to publishing a detailed report under **clause 7A.5(a)(iii)**, consult with End Users, Customers and Access Holders of the relevant Coal System and Train Operators, to identify and consider:
 - (A) whether changes can be made to:
 - (1) the operation and maintenance practices for the Rail Infrastructure;
 - (2) the operations of Rollingstock by Railway Operators;
 - (3) the operation and maintenance practices in respect of load-out facilities,

including in relation to interfaces with all facilities forming part of the relevant Supply Chains (as set out in the assumptions affecting Deliverable Network Capacity and included in the Initial Capacity Assessment

Report) in order to increase the Deliverable Network Capacity of the relevant Coal System, provided that such changes would be consistent with the System Operating Parameters included in the IE Initial Capacity Assessment (and would not require an Access Holder to revert to the requirements in an Access Agreement where that Access Agreement has not been modified to make it consistent with the new System Operating Parameters);

- (B) whether an Access Holder wishes to voluntarily relinquish any of its Access Rights if it is entitled to do so under, and in accordance with, a relinquishment provision in its Access Agreement (without being required to pay a Relinquishment Fee to Aurizon Network) with the Access Holder to specify the maximum and minimum number of Access Rights that the Access Holder would be willing to relinquish; and
 - (C) options for Expansions,
(collectively, the **Transitional Arrangements**),
which could effectively and efficiently address the Existing Capacity Deficit or whether affected Access Holders and Customers would prefer not to do anything to address the Existing Capacity Deficit; and
- (iii) within three (3) Months after the Initial Capacity Assessment Report has been published by the QCA on its website, submit a detailed report to the QCA, the Chair of the Rail Industry Group and the Independent Expert showing the outcome of Aurizon Network's analysis and consultation on the Existing Capacity Deficit and the Transitional Arrangements which it considers would most effectively and efficiently address the Existing Capacity Deficit, including:
- (A) whether any Access Holder is willing to, within 30 days, voluntarily relinquish any of its Access Rights if it is entitled to do so under, and in accordance with, a relinquishment provision in its Access Agreement (without being required to pay a Relinquishment Fee that would otherwise be payable as a result of such relinquishment under its Access Agreement) and the extent to which any voluntary relinquishment will address (up to a maximum of) the Existing Capacity Deficit in that Coal System). If multiple Access Holders wish to

relinquish Access Rights, then the voluntary relinquishment will be apportioned pro rata up to a maximum of the Existing Capacity Deficit in that Coal System;

- (B) whether changes could be made to:
- (1) the operation and maintenance practices for the Rail Infrastructure;
 - (2) the operations of Rollingstock by Railway Operators;
 - (3) the operation and maintenance practices in respect of load-out facilities,

including in relation to interfaces with all facilities forming part of the relevant Supply Chains (as set out in the assumptions affecting Deliverable Network Capacity and included in the Initial Capacity Assessment Report) that could increase the Deliverable Network Capacity of the relevant Coal System, provided that such changes would be consistent with the System Operating Parameters included in the IE Initial Capacity Assessment (and would not require an Access Holder to revert to the requirements in an Access Agreement where that Access Agreement has not been modified to make it consistent with the new System Operating Parameters), including:

- (4) the extent to which the proposed operational changes will address the Existing Capacity Deficit;
- (5) a reasonable estimate of the cost of such operational changes to Aurizon Network and/or Customers and Access Holders; and
- (6) if relevant, evidence of Aurizon Network's consultation under **clause 7A.5(a)(ii)** that explains why such changes cannot address the Existing Capacity Deficit;

- (C) if relevant, a shortlist of Expansions considered by Aurizon Network and through the consultation under **clause 7A.5(a)(ii)** (including reasonable estimates of costs to undertake each Expansion); and

- (D) subject to **clause 7A.5(c)**, any proposed Expansion which Aurizon Network and the affected Access Holders or Access Seekers have agreed will address the Existing Capacity Deficit.

- (b) The QCA may publish any report provided by Aurizon Network under **clause 7A.5(a)** on its website.
- (c) If:
- (i) Aurizon Network and the affected End Users jointly agree:
 - (A) that an Expansion is the most effective and efficient option to address the Existing Capacity Deficit; and
 - (B) on the terms of the Expansion proposal to be submitted to the Independent Expert,then **clause 7A.5(i)** will apply.
 - (ii) Aurizon Network and the affected End Users jointly agree that an Expansion is the most effective and efficient option to address the Expansion Capacity Deficit but have not agreed on the terms of the Expansion proposal to be submitted to the Independent Expert by the date the Aurizon Network is due to submit the report under **clause 7A.5(a)(iii)** then Aurizon Network may, acting reasonably, determine the Expansion proposal to be submitted to the Independent Expert and **clause 7A.5(i)** will apply and Aurizon Network must submit the Expansion proposal to the Independent Expert for review under **clause 7A.5(i)(i)**.
- (d) If affected End Users and Aurizon Network have not reached an agreement as to which of the Transitional Arrangements should be implemented, the Independent Expert must review any report provided by Aurizon Network under **clause 7A.5(a)(iii)** and promptly make a recommendation to the QCA with respect to which of the Transitional Arrangements of the type referred to in **clause 7A.5(a)(iii)(A) – clause 7A.5(a)(iii)(C)** it considers will most effectively and efficiently resolve the Existing Capacity Deficit, including with regard to which of the Transitional Arrangements will result in the lowest net present cost applying the Discount Rate to all Access Holders without prejudice to the reliability and performance (in the long and short term) of the Rail Infrastructure.
- (e) Within 15 days (or such longer period as may be required by the QCA) of receiving a recommendation from the Independent Expert, the QCA must make a determination as to which of the Transitional Arrangements of the type referred to in **clause 7A.5(a)(iii)(A) – clause 7A.5(a)(iii)(D)** will most efficiently and effectively resolve the Existing Capacity Deficit, including with regard to which of the Transitional Arrangements will result in the lowest net present cost applying the Discount Rate to all Access Holders without prejudice to the reliability and performance (in the long and short term) of the Rail Infrastructure provided that the QCA's determination must be consistent with the System Operating Parameters other than as is

required to accommodate an operational change deemed prudent by the QCA for the purpose of rectifying the Existing Capacity Deficit.

- (f) **Subject to clause 7A.5(h)**, Aurizon Network must comply with any determination made by the QCA under **clause 7A.5(e)** including by doing everything reasonably necessary to implement the type of Transitional Arrangements determined by the QCA in a prudent and diligent manner so as to resolve the Existing Capacity Deficit as soon as reasonably practicable, having regard to the nature and type of Transitional Arrangements required.
- (g) Aurizon Network's obligation under **clause 7A.5(f)** to implement the Transitional Arrangements (other than Expansions) is limited to the extent that such Transitional Arrangements:
 - (i) are within the control of Aurizon Network;
 - (ii) would not place Aurizon Network in breach of any applicable Safeworking Procedures and Safety Standards; and
 - (iii) would not place Aurizon Network in breach of its obligations under this Undertaking or any Access Agreement. In determining whether a Transitional Arrangement would put Aurizon Network in breach of an Access Agreement, that determination would be made on the basis that any change in a System Operating Parameter had been reflected in the relevant Access Agreement as contemplated by **clause 7A.12**.
- (h) To the extent Aurizon Network is required to implement operational changes and, in doing so, incurs costs that it would not otherwise be entitled to recover in accordance with this Undertaking, Aurizon Network will be entitled to recover such costs (provided those costs are reasonable and pre-approved by the QCA).
- (i) If Aurizon Network and affected End Users agree that an Expansion is the most effective and efficient option to address the Existing Capacity Deficit and End Users wish to rectify the Existing Capacity Deficit, or if the QCA otherwise determines that an Expansion is the most effective and efficient option to address the Existing Capacity Deficit, then:
 - (i) the Independent Expert must review and approve the efficiency and prudence of the proposed Expansion prior to Aurizon Network incurring any construction expense in relation to the proposed Expansion. Where the Independent Expert does not approve the efficiency and prudence of the Expansion, Aurizon Network must submit an alternative proposal that:
 - (A) Aurizon Network and the affected End Users have agreed will address the Existing Capacity Deficit for approval; or

- (B) (if Aurizon Network and the affected End Users have not agreed an alternative proposal within 20 Business Days after the Independent Expert decides not to approve the efficiency and prudence of the Expansion), Aurizon Network (acting reasonably) determines will address the Existing Capacity Deficit;
- (ii) any alternative proposal required to be submitted by Aurizon Network in accordance with this **clause 7A.5(i)(i)** will be reviewed by the Independent Expert for efficiency and prudence. Unless and until the Independent Expert approves the efficiency and prudence of the proposed Expansion (as set out in any alternative proposal required to be submitted by Aurizon Network in accordance with this **clause 7A.5(i)(i)**), Aurizon Network must not incur any construction expenditure in relation to the proposed Expansion. Subject to **clause 7A.5(i)(iv)**, Aurizon Network is obliged to promptly undertake and fund the Expansion at the Approved WACC applicable from time to time;
- (iii) the value of the Expansion will be included in the Regulatory Asset Base;
- (iv) Aurizon Network will only be obliged to undertake and fund an Expansion up to an amount of \$300 million (in aggregate across all Expansions required in accordance with this clause); and
- (v) for clarity, the pricing principles to apply to an Expansion are set out in **Part 6** and **Schedule F**.
- (j) Aurizon Network acknowledges that an Existing Capacity Deficit does not reduce an Access Holder's entitlement to Access Rights under an existing Access Agreement, except to the extent an Access Holder elects to voluntarily relinquish its Access Rights under this **Part 7A**.
- (k) Nothing in this **clause 07A.5** affects or limits Aurizon Network's obligations or liabilities in respect of an Access Agreement or any other agreement entered into in accordance with this Undertaking.
- (l) Despite **clause 2.4(f)** and anything contrary in an Access Agreement, where this **Part 7A** specifies that a Relinquishment Fee is not payable, Aurizon Network will not collect, and will not be deemed to collect (for the purposes of the calculation of Total Allowable Revenue under **Part 7A**), any Relinquishment Fee.

7A.6 Rebate

- (a) This **clause 7A.6** commences to apply from the Report Date.
- (b) From the Report Date, the Independent Expert must identify if there has been any AN Performance Shortfall resulting from an AN

Performance Breach in that Relevant Year. If there has been an AN Performance Shortfall resulting from an AN Performance Breach, the Independent Expert must determine the Performance Rebate Amount that Aurizon Network must, subject to **clause 7A.6(c)** and **clause 7A.6(e)**, pay an affected End User (**Rebate**). In determining the Performance Rebate Amount for the Year in which the Report Date occurs, the Independent Expert will only have regard to any AN Performance Shortfall resulting from an AN Performance Breach that occurred between the Report Date and the end of that Year. In subsequent Years following the Year in which the Report Date occurs, the Independent Expert will have regard to AN Performance Shortfalls resulting from an AN Performance Breach for all of the Relevant Year.

- (c) Aurizon Network's liability to pay an End User any Rebate under **clause 7A.6(a)** is conditional upon:
- (i) the Access Holder (where it is not the End User) or the End User advising Aurizon Network in writing of the identity of the End User to whom the Rebate is payable;
 - (ii) the Access Holder and the End User first undertaking in writing in favour of Aurizon Network that:
 - (A) the payment of the Rebate to the End User is the sole right to compensation;
 - (B) for clarity, where the Access Holder and the End User are different entities, the Access Holder does not have a separate right of compensation from the End User; and
 - (C) Aurizon Network is not otherwise liable to the Access Holder or End User for any claim (whether based in contract or tort, under common law or in equity or under statute) for any other loss or damage suffered or incurred,in respect of the Train Service Entitlements which were not provided as a result of an AN Performance Breach, subject only to any other rights available to the Access Holder or End User:
 - (D) for a wilful breach by Aurizon Network of any Access Agreement or the Undertaking;
 - (E) under the termination provisions of any Access Agreement; and
 - (F) under the Act;
 - (iii) prior to giving such undertaking, the Access Holder and End User in respect of the relevant Train Service Entitlement not having commenced any claim that would be in breach of

- such undertaking if such undertaking had been given at the time the claim was commenced; and
- (iv) the Access Holder and End User agreeing, as part of the undertaking referred to in **clause 7A.6(c)(ii)**, that it will not set off any amounts which are due and payable by the Access Holder or End User (as applicable) to Aurizon Network against the Rebate payable by Aurizon Network to that Access Holder or End User.
- (d) Aurizon Network must:
- (i) issue a recipient created tax invoice (**RCTI**) within 5 Business Days after the Independent Expert determines any Rebate that Aurizon Network must pay an affected End User;
 - (ii) pay the affected End User the amount set out in an RCTI given under **clause 7A.6(d)(i)** within 20 Business Days after the RCTI is given to the affected End User;
 - (iii) pay the Rebate:
 - (A) in Australian currency; and
 - (B) by direct deposit into one Australian bank account notified by the End User to Aurizon Network; and
 - (iv) not set off the Rebate against any amounts which are due and payable by the affected Access Holder or End User (as applicable) to Aurizon Network.
- (e) Aurizon Network will not be liable to pay a Rebate to an End User where the AN Performance Shortfall resulted from an AN Performance Breach related to the breach of a System Operating Parameter that that End User did not agree to be reflected in the relevant Access Agreement for that End User following a request from Aurizon Network to amend the Access Agreement to incorporate that System Operating Parameter in accordance with **clause 7A.12**.
- (f) On 13 January 2023 (**Review Point**), if requested by an End User, at least 30 days prior to the Review Point, the QCA must consider whether the Rebate mechanism as described in this **clause 7A.6** is achieving the Rebate Objectives (**Review**).
- (g) For the purposes of **clauses 7A.6(f), 7A.6(h), 7A.6(i), 7A.6(j) and 7A.6(k)**, “**Rebate Objectives**” means:
- (i) provision of comprehensive and transparent information, and support by Aurizon Network for the Independent Expert’s work in relation to the determination of the Rebate;
 - (ii) accurate, reliable and timely root cause analysis of the reasons why an End User’s Train Service Entitlements are

- unable to be ordered, are ordered but not provided, or are not utilised; and
- (iii) timely and effective provision of an individual Rebate to End Users calculated in accordance with **clause 7A.6(b)** in circumstances where an End User has received less than their Train Service Entitlements in a Year due to an AN Performance Breach.
- (h) In conducting a Review, the QCA must seek submissions from End Users, Aurizon Network, the Independent Expert and Train Operators on whether they consider the Rebate Objectives, have been met in a material way, including supporting evidence.
 - (i) The QCA must determine, on the basis of the information received under **clause 7A.6(h)** and any other information reasonably available to the QCA, whether the Rebate Objectives have been met in a material way.
 - (j) If the QCA considers that the Rebate Objectives have not been met in a material way, the QCA must review the Rebate mechanism and:
 - (i) determine whether amendments can be made to the Undertaking in order to ensure that the Rebate Objectives are achieved;
 - (ii) publish any recommended amendments referred to in **clause 7A.6(j)(i)**;
 - (iii) provide End Users, Aurizon Network, the Independent Expert and Train Operators with a reasonable opportunity to make submissions on the QCA's recommended amendments under **clause 7A.6(j)(ii)** within a time period specified by the QCA; and
 - (iv) provide a final decision on recommendations for End Users and Aurizon Network to consider for inclusion in the Undertaking.
 - (k) In the event that:
 - (i) the QCA determines in the final decision referred to in **clause 7A.6(j)(iv)** that the Rebate Objectives have not been met in a material way; and
 - (ii) within 90 days of the QCA's final decision referred to in **clause 7A.6(j)(iv)** Aurizon Network has not submitted a draft amending access undertaking that either:
 - (A) reflects the recommendations in the QCA's final decision as to changes required to the Undertaking; or
 - (B) is in a form that has been agreed by Aurizon Network and a Majority of End Users, which must

include all End Users that requested the QCA undertake the Review,

(each, a **Reset WACC Reduction Event**),

the Undertaking will (without the need for any other action to be taken by Aurizon Network or the QCA) be deemed to have been amended so that the definition of 'Reset WACC' will, effective from the Reset Date, be amended such that:

- (iii) the reference to '6.3%' in paragraph (a)(i) of the definition of 'Reset WACC' is replaced with '6.0%'; and
 - (iv) the reference to '0.4%' in paragraph (b) of the definition of 'Reset WACC' is replaced with '0.1%'.
- (l) Aurizon Network must do all things reasonably required to give effect to a deemed amendment under **clause 7A.6(k)**, including making any other necessary consequential amendments to this Undertaking.
 - (m) The QCA will endeavour to make its determination under **clause 7A.6(j)** by the Reset Date.
 - (n) If a Reset WACC Reduction Event occurs then:
 - (i) **clauses 7A.6(a) to 7A.6(e)** will cease to apply with effect from the Reset Date provided however that those clauses will continue to apply, to the extent required, with respect to any Rebates that accrued during the period prior to the Reset Date; and
 - (ii) Aurizon Network must do all things reasonably required to give effect to **clause 7A.6(n)(i)**, including making any other necessary consequential amendments to this Undertaking.
 - (o) To the extent that the Independent Expert determines that:
 - (i) Aurizon Network is liable to pay a Rebate and Aurizon Network does not dispute that determination within 20 Business Days after the Independent Expert makes its determination but fails to pay the Rebate within the timeframe required by **clause 7A.6(d)**; or
 - (ii) Aurizon Network failed to provide the information required for the Independent Expert to make a decision as to whether a Rebate is payable or to determine the Performance Rebate Amount,

the affected End User may raise a dispute under **Part 11**.

7A.7 Network Management Principles

7A.7.1 Compliance with Network Management Principles

- (a) Aurizon Network must:

- (i) perform scheduling, Network Control and associated services; and
 - (ii) provide Capacity related information to Access Holders and Train Operators (in respect of the Access Rights to which its Train Operations Deed relates),
- in accordance with the Network Management Principles.
- (b) Any dispute in relation to compliance with the Network Management Principles will be dealt with in accordance with **Part 11**, except to the extent the dispute arises in respect of rights under an Access Agreement or Train Operations Deed in which case the dispute will be dealt with in accordance with the dispute resolution process set out in the relevant agreement.

7A.7.2 Nature of the System Rules

- (a) The System Rules specify in greater detail the way in which Aurizon Network must plan, schedule and control the operation of Train Services on a single or combination of Coal Systems in accordance with the Network Management Principles.
- (b) The System Rules must be published on the Website.

7A.7.3 Making the initial System Rules for a Coal System

- (a) Where System Rules do not already exist for a Coal System (whether individually or together with other Coal Systems), then within two (2) Months of the Approval Date or the approval of a new Coal System under this Undertaking, Aurizon Network must:
 - (i) develop the initial System Rules for that Coal System including, where Aurizon Network elects to do so:
 - (A) together with one (1) or more other Coal Systems; or
 - (B) by way of amending existing System Rules to apply in relation to that Coal System; and
 - (ii) for a period of no longer than three (3) Months, consult with Access Holders, Railway Operators and Access Seekers whose Train Services will be affected by the System Rules or amended System Rules, as applicable, and any affected Infrastructure Service Providers, in relation to the introduction of the System Rules or amended System Rules, as applicable.
- (b) Within one (1) Month after the completion of the consultation process under **clause 7A.7.3(a)**, Aurizon Network must:
 - (i) prepare the proposed System Rules or amended System Rules, as applicable, (**Draft System Rules**) having regard to the equitable operation of the Draft System Rules across Access Holders and Access Seekers (should they become

Access Holders) and their Customers and the terms of Access Agreements;

- (ii) in preparing the Draft System Rules, seek to ensure that they do not conflict with the Network Management Principles, the System Operating Parameters or any provision of this Undertaking; and
- (iii) submit the Draft System Rules to the QCA for approval.

7A.7.4 *Reviewing and amending the System Rules*

- (a) This **clause 7A.7.4**:
 - (i) does not apply to an amendment of System Rules referred to under **clause 7A.7.3(a)(i)(B)**; but
 - (ii) applies to a review of the System Rules developed under **clause 7A.7.3**.
- (b) Without limiting Aurizon Network's right to review any System Rules from time to time, Aurizon Network must review the System Rules (and seek and have regard to the Independent Expert's view in relation to the System Rules) immediately upon Aurizon Network becoming aware of the occurrence of any of the following events:
 - (i) Capacity in the relevant Coal System (or, if more than one (1), Coal Systems in aggregate) to which the relevant System Rules apply changes by greater than 10% of the existing total number of relevant Train Paths on a Monthly basis;
 - (ii) Yearly Cyclic Traffic or Timetabled Traffic (as applicable) changes by greater than 10% of the previous Year's number of relevant Train Paths;
 - (iii) a new loading facility, port terminal or unloading facility becomes (or is reasonably likely to become) connected to a relevant Coal System; or
 - (iv) a material change to the System Operating Parameters or the Network Management Principles which subsequently affects the operations of the System Rules,and despite whether or not any of the events outlined in this **clause 7A.7.4(b)** have occurred, at least once per Year.
- (c) If Aurizon Network has reviewed the System Rules, then Aurizon Network must:
 - (i) notify the QCA (who may, if it determines necessary, publish the information provided on the QCA's website) and each of the following:
 - (A) Access Holders and Access Seekers and their Customers (but only to the extent that the Access

- Holder or Access Seeker has given Aurizon Network those Customer contact details) whose Train Services will be affected by any amendments necessary as a result of such review;
- (B) affected infrastructure providers for infrastructure forming part of the relevant Supply Chain (including, for example, the unloading facility operator that is the destination of Train Services operating in the relevant Coal System);
 - (C) affected Infrastructure Service Providers;
 - (D) affected Railway Operators,
- (collectively, the **Affected Persons**) of the following matters:
- (E) the outcome of the review and the necessity (or otherwise) to amend the System Rules;
 - (F) if the System Rules are to be amended, the proposed amendments (**Proposed Amendments**);
 - (G) reasons for the Proposed Amendments or the decision to not amend the relevant System Rules; and
 - (H) details of the impact the Proposed Amendments will or may have on the delivery of each Affected Person's Train Service Entitlements;
- (ii) consult with the Affected Persons;
 - (iii) have regard to the equitable operation of the System Rules across Access Holders and Access Seekers (should they become Access Holders) and the Customers of the Access Holders and Access Seekers (should they become Access Holders) and the terms of Access Agreements;
 - (iv) ensure that the amendments do not conflict with the Network Management Principles, System Operating Parameters or any provision of this Undertaking; and
 - (v) ensure that the amendments are appropriate having regard to the matters listed in section 138(2) of the Act.
- (d) If a person (acting reasonably and in good faith):
- (i) disagrees with the outcome of Aurizon Network's review of the System Rules notified under **clause 7A.7.4(c)(i)**; or
 - (ii) considers that the Proposed Amendments:
 - (A) would not, as a whole, operate equitably amongst Access Holders and Access Seekers (should they become Access Holders) and the Customers of the

Access Holders and Access Seekers (should they become Access Holders); or

- (B) are inconsistent with this Undertaking (including the Network Management Principles and System Operating Parameters); or
- (C) are inappropriate having regard to the matters listed in section 138(2) of the Act,

then that person may, within twenty (20) Business Days after being given a notice under **clause 7A.7.4(c)(i)** or the publication on the QCA website, provide a written submission to Aurizon Network identifying its view with respect to **paragraphs (A) to (C)**.

- (e) Immediately following the expiration of the time period under **clause 7A.7.4(d)**, Aurizon Network must:
 - (i) notify the Affected Persons and any person who provides Aurizon Network with a written submission under **clause 7A.7.4(d)** that the Proposed Amendments are being referred to the QCA for approval;
 - (ii) submit the Proposed Amendments to the QCA for approval; and
 - (iii) provide the QCA:
 - (A) all submissions provided to Aurizon Network within the time period under **clause 7A.7.4(d)**;
 - (B) an assessment of those submissions by Aurizon Network;
 - (C) any variations to the Proposed Amendments that Aurizon Network proposes to make after taking into account the submissions (**Variations**); and
 - (D) details of the impact the Proposed Amendments and Variations will or may have on the delivery of each Affected Person's Train Service Entitlements.

7A.7.5 Approval of System Rules

- (a) If Aurizon Network has submitted:
 - (i) Draft System Rules to the QCA under **clause 7A.7.3(b)(iii)**; and
 - (ii) Proposed Amendments (or Variations, if any) to the QCA under **clause 7A.7.4(e)(ii)**,

(Proposed System Rules) the QCA must:

 - (iii) publish the Proposed System Rules on its website; or

- (iv) assess the Proposed System Rules (together with any submissions provided to Aurizon Network under **clause 7A.7.4(d)**); and
- (v) seek submissions in respect of the Proposed System Rules.
- (b) The QCA may approve the Proposed System Rules only if the QCA:
 - (i) is satisfied they are consistent with this Undertaking (including the Network Management Principles);
 - (ii) is satisfied that they are in accordance with the notice given under **clause 7A.7.5(d)**, if any; and
 - (iii) considers it appropriate to do so having regard to the matters listed in section 138(2) of the Act.
- (c) If the QCA approves the Proposed System Rules, it must give notice to Aurizon Network of its approval, specifying the date on which the proposed amendments will take effect.
- (d) If the QCA refuses to approve the Proposed System Rules, then the QCA will give Aurizon Network a notice:
 - (i) stating the reasons for its refusal; and
 - (ii) requiring Aurizon Network to amend the Proposed System Rules to address the matters in the QCA's reasons or submit additional information, to address the matters in the QCA's reasons within twenty (20) Business Days after the giving of that notice (or such other period as the QCA may in its absolute discretion determine).
- (e) The QCA may develop System Rules consistent with this Undertaking if:
 - (i) Aurizon Network does not submit Draft System Rules in accordance with **clause 7A.7.3(b)(iii)**;
 - (ii) Aurizon Network does not resubmit the Proposed System Rules in accordance with **clause 7A.7.5(d)(ii)**; or
 - (iii) the QCA refuses to approve the Proposed System Rules that were resubmitted in accordance with **clause 7A.7.5(d)(ii)**.
- (f) If the QCA develops Draft System Rules under **clause 7A.7.5(e)** despite **clause 7A.7.5(a)**, the QCA must:
 - (i) publish the Draft System Rules on its website;
 - (ii) invite persons to make submissions on the Draft System Rules to the QCA within a reasonable time specified by the QCA; and
 - (iii) consider any submissions it receives within the time specified.

- (g) **Clauses 7A.7.5(a) to 7A.7.5(d)** will:
 - (i) apply to any Proposed System Rules resubmitted to the QCA under **clause 7A.7.5(d)(ii)**;
 - (ii) apply to any additional information submitted to the QCA under **clause 7A.7.5(d)(ii)** (including where the Proposed System Rules are not amended) as though Aurizon Network were resubmitting the same Proposed System Rules but with the additional information; and
 - (iii) continue to apply until the QCA approves the Proposed System Rules for the relevant Coal System.
- (h) If the QCA approves the Proposed System Rules, then:
 - (i) the relevant System Rules take effect on the date of the approval or such later date as specified in the System Rules or the approval;
 - (ii) in the case of Proposed Amendments and Variations, the relevant System Rules are taken to have been amended in accordance with the Proposed Amendments and Variations;
 - (iii) the QCA must give Aurizon Network a notice providing the reasons for its decision; and
 - (iv) Aurizon Network must publish the amended System Rules on its Website.
- (i) Nothing in this **clause 7A.7.5** prevents Aurizon Network from seeking subsequent amendments to any System Rules even if the QCA has previously refused to approve Proposed Amendments in relation to those System Rules.

7A.7.6 General provisions

- (a) For the purposes of this **clause 7A.7.6**:
 - (i) the amending of the System Rules includes replacing or removing the System Rules; and
 - (ii) Proposed Amendments includes a proposed replacement or removal of System Rules.
- (b) The System Rules may be withdrawn by Aurizon Network only with the approval of the QCA.
- (c) If the QCA considers that the System Rules require amendment, the QCA may require Aurizon Network to submit replacement System Rules within a reasonable period advised by the QCA, in which case **clause 7A.7.5** applies.

7A.8 Supply Chain coordination

7A.8.1 *Proposal for Supply Chain Coordination Entity*

- (a) Promptly following the Approval Date, Aurizon Network will, by the provision of notice in writing to all Access Holders, all Customers, all port operators and all Train Operators, initiate a process to develop a proposal (**Supply Chain Proposal**) for consideration by all Supply Chain Participants for an independent body to undertake functions relevant to Supply Chain coordination across the Central Queensland Coal Network (**Supply Chain Coordination Entity**).
- (b) For the purpose of the efficient development of the Supply Chain Proposal, Aurizon Network must, and each other Supply Chain Participant will have the right to, nominate a representative to a working group tasked to deliver the Supply Chain Proposal.
- (c) Aurizon Network must participate in the design and development of the Supply Chain Proposal and negotiate in good faith with the other members of the working group with respect to the Supply Chain Proposal.
- (d) The working group must by no later than 6 months after the Approval Date prepare a set of governance principles for the development of the Supply Chain Proposal for consideration and approval by all Supply Chain Participants. In developing the governance principles, the working group must have regard to the following matters:
 - (i) timing and location of meetings of the working group;
 - (ii) timing of reporting to all Supply Chain Participants on progress of the Supply Chain Proposal;
 - (iii) a process for engagement of any external advisers to the working group;
 - (iv) the time period during which the Supply Chain Proposal will be developed and presented to all Supply Chain Participants, which should be no later than 18 months from the Approval Date;
 - (v) a requirement for all Supply Chain Participants to approve the Supply Chain Proposal in writing prior to implementation of any element of the Supply Chain Proposal into the Supply Chain;
 - (vi) the process for implementation of the Supply Chain Proposal, including any amendments which are required to be made to this Undertaking prior to such implementation; and
 - (vii) any other matter the working group considers necessary for the efficient development, and consideration by all Supply Chain Participants of the Supply Chain Proposal.

- (e) In developing the Supply Chain Proposal, the working group must have regard to each of the following matters:
 - (i) the identity of the Supply Chain Coordination Entity and the contractual terms on which it will be appointed;
 - (ii) the scope and role of the Supply Chain Coordination Entity, including:
 - (A) responsibility for scheduling of Train Services to all ports to seek to ensure Committed Capacity is delivered and that losses are minimised while enabling efficient utilisation of latent capacity in the Supply Chain;
 - (B) optimising and coordinating maintenance planning with all participants in a Supply Chain to maximise system capacity and throughput;
 - (C) the process and methodology to be applied in the allocation of responsibility for losses arising in any part of the Supply Chain;
 - (D) reporting to all Supply Chain Participants on:
 - (1) the performance of the Supply Chain;
 - (2) any losses arising in any part of the Supply Chain;
 - (3) the Supply Chain Coordination Entity's allocation of responsibility for such losses; and
 - (E) assistance with Supply Chain planning and modelling, including maintenance planning to maximise system capacity; and
 - (iii) the treatment of the costs associated with the engagement of the Supply Chain Coordination Entity.
- (f) In developing the Supply Chain Proposal the working group must assess and have regard to:
 - (i) the impact to each Supply Chain Participant and the Supply Chain as a whole of the Supply Chain Proposal;
 - (ii) the feasibility (on a practical and cost benefit analysis basis) of the Supply Chain Proposal; and
 - (iii) any provisions in this Undertaking that would need to be amended by way of a draft amending access undertaking, having regard to the proposed role of the Supply Chain Coordination Entity.

- (g) Aurizon Network must not implement any Supply Chain Proposal without the unanimous support of all Supply Chain Participants in the relevant Coal System.

7A.8.2 Aurizon Network's participation in Supply Chain Groups

- (a) Subject to **clause 7A.8.2(c)**, Aurizon Network must, if and to the extent requested by a Supply Chain Group, participate in:
 - (i) only one Supply Chain Group per Coal System (except in respect of the Goonyella System);
 - (ii) each Supply Chain Group with a view to:
 - (A) achieving coordination and effective performance of a relevant Supply Chain; and
 - (B) if applicable, the development of a Supply Chain Master Plan for the relevant Supply Chain;
 - (iii) subject to Aurizon Network's obligations in relation to Confidential Information, discussions with other service providers and participants in the Supply Chain to seek to ensure the coordination of maintenance activities (including Maintenance Work) in the relevant Supply Chain;
 - (iv) subject to the terms of the Undertaking and any Access Agreement and subject to it not impacting the delivery of Committed Capacity, the consideration, development and implementation of productivity improvement initiatives and trials (including the use of any Trains that vary from the characteristics required by the Reference Train Service) with other service providers and participants in the Supply Chain to improve the efficiency and performance of the relevant Supply Chain; and
 - (v) studies into mechanisms for improvement of safety and above rail productivity including the deployment of an automatic train protection system.
- (b) Aurizon Network is not obliged to:
 - (i) undertake any activity referred to in **clause 7A.8.2(a)(iv)** and **(v)** unless the reasonable cost (including a margin consistent with market practice) of undertaking that activity is recoverable by Aurizon Network, to the extent such costs will not already be included in the calculation of the Maximum Allowable Revenue; or
 - (ii) make any binding commitment or to take any action as a result of any activity undertaken as contemplated by **clause 7A.8.2(a)**.

- (c) Subject to **clause 7A.8.2(b)(i)**, without limiting the nature of Aurizon Network's participation, if requested by a Supply Chain Group (acting reasonably), Aurizon Network must:
 - (i) participate in the development of and undertake regular reviews of that Supply Chain Group's Supply Chain Master Plan;
 - (ii) review options for the development of Capacity being investigated by the Supply Chain Group and advise if and how any option is likely to impact on the Network Management Principles, System Operating Parameters or System Rules for the relevant Coal System, the Approved Maintenance Strategy and Budget and Renewals Strategy and Budget; and
 - (iii) investigate operational changes that could increase Capacity in the relevant Coal System, in which case Aurizon Network must investigate the operational changes that could increase Capacity in the relevant Supply Chain. (In respect of the Goonyella System, where there is more than one Supply Chain Group, this **clause 7A.8.2(c)(iii)** operates in respect of each of those Supply Chain Groups).
- (d) Aurizon Network acknowledges and agrees that nothing in this **clause 7A.8.2** gives Aurizon Network the power to give any Supply Chain Group a binding direction or requires any Supply Chain Group to comply with any direction purported to be given by Aurizon Network under this **clause 7A.8.2**.

7A.8.3 Aurizon Network's Supply Chain obligations

- (a) Subject to the terms of this Undertaking, and Aurizon Network not breaching its Access Agreement or Safety Standards, Aurizon Network must, in respect of each Supply Chain, use reasonable endeavours to cooperate and coordinate with all elements of a Supply Chain (including non-coal users) with a view to:
 - (i) maximising the efficiency and performance of the relevant Supply Chain; and
 - (ii) in planning and implementing Operational Constraints, to the extent practicable, minimising disruption to the operation of Train Services, including to minimise disruption to Train Service Entitlements and Nominated Monthly Operational Rights.
- (b) If:
 - (i) a Supply Chain Group identifies an operational change to its Coal System which change may improve Capacity in the relevant Coal System;

(ii) the Supply Chain Group notifies Aurizon Network of the operational change; and

(iii) Aurizon Network decides not to implement the change,

Aurizon Network will provide the Supply Chain Group with reasonably detailed reasons for not implementing the change which may include the impact of the operational change on other Coal Systems.

7A.9 System Operating Parameters

(a) This clause **7A.9** only applies for the period prior to the Initial Capacity Assessment Report being published by the QCA on its website as contemplated by **clause 7A.4.1(h)**. **Clause 7A.9(h)** also applies for the period after to the Initial Capacity Assessment Report being published by the QCA on its website as contemplated by **clause 7A.4.1(h)**. Following publication of the Initial Capacity Assessment Report, the System Operating Parameters will be those determined by the Independent Expert as contemplated by **clause 7A.4.1**.

(b) Aurizon Network must ensure that System Operating Parameters are in place for each Coal System at all times.

(c) In reviewing the System Operating Parameters for a Coal System, Aurizon Network will:

(i) notify the QCA (who may, if determined necessary by the QCA, publish the information provided on its Website) and each of the following:

(A) Access Holders and Access Seekers (and Customers but only to the extent that the Access Holder or Access Seeker has given Aurizon Network those Customer contact details) whose Train Services will be affected by any amendments necessary as a result of such review;

(B) the applicable Supply Chain Group (if any);

(C) affected infrastructure providers for infrastructure forming part of the relevant Supply Chain (including, for example, the unloading facility operator that is the destination of Train Services operating in the relevant Coal System);

(D) affected Infrastructure Service Providers; and

(E) affected Railway Operators,

of the relevant System Operating Parameters and the time in which to make submissions;

(ii) consider any submissions received in respect of the proposed System Operating Parameters or whether any

- variation of the System Operating Parameters is required (as applicable);
- (iii) seek to be consistent with Aurizon Network's assumptions affecting Capacity and relied upon for the most recent Capacity Assessment (or Baseline Capacity Assessment, as applicable);
 - (iv) ensure that any amendments to the System Operating Parameters:
 - (A) do not conflict with any provision of this Undertaking; and
 - (B) are appropriate having regard to the matters listed in section 138(2) of the Act; and
 - (v) respond (with reasons) to any such submissions within fifteen (15) Business Days of receipt of the submission (or such longer period approved by the QCA) including whether and, if so, how Aurizon Network has varied the proposed or existing System Operating Parameters (as applicable) in response to those submissions.
- (d) Without limitation to **clause 7A.9(c)**, Aurizon Network will review the System Operating Parameters for a Coal System as soon as practicable after:
- (i) Aurizon Network becomes aware that any sustained change has occurred, or will occur, to that Coal System that materially affects the System Operating Parameters;
 - (ii) a new coal basin or port terminal is connected to the Rail Infrastructure;
 - (iii) the completion of a major Expansion; or
 - (iv) being requested by the QCA or by 60% of Access Holders (or its Customers) on the relevant Coal System.
- (e) Nothing in this **clause 7A.9** obliges Aurizon Network to vary the System Operating Parameters.
- (f) Aurizon Network must keep its most current System Operating Parameters available on the Website.
- (g) Aurizon Network must provide the current System Operating Parameters as a complete and transparent document to:
- (i) the QCA on an unredacted basis;
 - (ii) stakeholders and when published on its Website:
 - (A) in respect of agreements entered into after the Approval Date of the 2016 Undertaking and to the extent permitted by any confidentiality obligations it may have in relation to the information contained in

the System Operating Parameters (and if those obligations permit disclosure if required by this Undertaking then Aurizon Network is required to disclose the information contained in the System Operating Parameters), on an unredacted basis; and

(B) in respect of agreements entered into prior to the Approval Date of the 2016 Undertaking or if complete disclosure is not permitted by Aurizon Network's confidentiality obligations:

(1) Aurizon Network must use all reasonable endeavours to obtain the consent of the relevant Third Party to disclose the information contained in the System Operating Parameters on an unredacted basis;

(2) in respect of the information for which consent is obtained under **paragraph (ii)(B)(1)**, on an unredacted basis; and

(3) in respect of the information for which consent is not obtained under **paragraph (ii)(B)(1)**:

- to the extent possible on an unredacted basis but aggregated so as to avoid disclosing the information that is confidential and unable to be disclosed; and
- to the extent not possible, on a redacted basis.

(h) Aurizon Network must use reasonable endeavours to agree to confidentiality obligations which:

(i) do not prevent the disclosure of the information contained in the System Operating Parameters; and

(ii) permit disclosure of information required by this Undertaking, but

(iii) in any event, must not agree to any confidentiality obligations that prevent disclosure to the QCA,

provided that Aurizon Network will be deemed to have complied with its obligations under this **clause 7A.9(h)** if it has requested during the negotiation of an Access Agreement that the Access Seeker agrees to confidentiality obligations in accordance with **clause 7A.9(h)(i)** and

clause 7A.9(h)(ii), whether or not the Access Seeker actually agrees to the inclusion of such obligations in the Access Agreement.

- (i) Aurizon Network must ensure that the System Operating Parameters are consistent with Good Engineering Practices.
- (j) To the extent the System Operating Parameters are different to the System Operating Parameters published as at the Approval Date on the Website, on, or as soon as reasonably practicable after, the Approval Date, Aurizon Network will make available to the QCA and to each Access Holder (and its Customer and Train Operator, if any) the System Operating Parameters (as at the Approval Date) relevant to that Access Holder or Train Operator in a form that does not disclose any confidential information regarding individual Access Holders, Customers or Train Operators, to avoid disclosing any information that is commercially sensitive to an Access Holder, Customer or Train Operator.

7A.10 Network Development Plan

- (a) Aurizon Network must develop a Network Development Plan and keep its most current Network Development Plan available on the Website.
- (b) The Network Development Plan must contain the following information:
 - (i) in respect of each Expansion being studied or investigated by Aurizon Network as a Concept Study, Pre-feasibility Study or Feasibility Study, the proposed scope, standard and preliminary determination of the cost of the proposed Expansion; and
 - (ii) the studies and investigations that Aurizon Network is undertaking or expects to undertake to inform the next review and update of the Network Development Plan.
- (c) Aurizon Network will consult with the Independent Expert in reviewing and before updating the Network Development Plan annually or more frequently as it considers necessary, including:
 - (i) if circumstances change in a way that Aurizon Network expects will materially affect the Network Development Plan;
 - (ii) if a new coal basin or port terminal is connected to the Rail Infrastructure;
 - (iii) at the completion of a major Expansion; or
 - (iv) where requested by the QCA or by 60% of Access Holders (or its Customers) on the relevant Coal System.
- (d) In developing or reviewing the Network Development Plan, Aurizon Network must:
 - (i) ensure the Network Development Plan has regard to:

- (A) the Network Management Principles;
- (B) any:
 - (1) System Operating Parameters;
 - (2) Supply Chain Master Plan; and
- (ii) notify the QCA (who may, if determined necessary by the QCA, publish the information provided on its Website) and each of the following:
 - (A) Access Holders and Access Seekers and its Customers (but only to the extent that the Access Holder or Access Seeker has given Aurizon Network those Customer contact details);
 - (B) affected infrastructure providers for infrastructure forming part of the relevant Supply Chain (including, for example, the unloading facility operator that is the destination of Train Services operating in the relevant Coal System);
 - (C) affected Infrastructure Service Providers;
 - (D) affected Railway Operators; and
 - (E) other interested parties identified by Aurizon Network in relation to the proposed Network Development Plan;
- (iii) consider submissions received from any interested parties;
- (iv) have regard to:
 - (A) forecast changes in demand for Queensland coal exports;
 - (B) any relevant Access Applications;
 - (C) any relevant port terminal developments or development of other out-loading facilities;
 - (D) any relevant previous or current studies undertaken by Aurizon Network; and
 - (E) other developments or circumstances which in Aurizon Network's opinion are relevant to the Network Development Plan;
- (v) make a draft Network Development Plan available to the QCA and each person identified in **clause 7A.10(d)(ii)** and provide twenty (20) Business Days for comments or submissions to be made by those persons before finalising the Network Development Plan for publication on the Website.

- (e) If Access Holders, Access Seekers or its Customers (if relevant) notify Aurizon Network that they require a peer review to be conducted of the Network Development Plan, then Aurizon Network must cooperate with a consultant appointed to conduct that peer review by and at the cost of the Access Holders, Access Seekers and its Customers (if relevant), except that Aurizon Network is not obliged to cooperate with more than one consultant for a review contemplated under this clause.
- (f) Any Dispute regarding the contents of the Network Development Plan must be determined in accordance with **Part 11**.
- (g) Neither anything in this **clause 7A.10**, nor the development, review or notification of a Network Development Plan, gives rise to any commitment by, representation by or obligation on Aurizon Network in relation to funding, constructing, permitting or otherwise implementing any aspect of the Network Development Plan.

7A.11 Maintenance Work

7A.11.1 Maintenance Objectives

- (a) Aurizon Network must ensure that all Maintenance Work is undertaken in a manner that:
 - (i) is consistent with:
 - (A) the Approved Maintenance Strategy and Budget applicable at that time (if any); or
 - (B) for any period prior to the first Approved Maintenance Strategy and Budget, the approach to maintenance reflected in the QCA's 2018 Decision for the relevant Year (**Approved Maintenance Approach**),
 subject to:
 - (C) **clause 7A.11.3(q)**; and
 - (D) any variations from:
 - (1) the Approved Maintenance Strategy and Budget; or
 - (2) the Approved Maintenance Approach, as applicable, including for unplanned maintenance, that Aurizon Network (acting reasonably and for a purpose that is solely related to the safety, reliability or performance of the Rail Infrastructure (both in the long and short term)) considers prudent and efficient or necessary, including in order to meet Safety Standards, address an emergency or manage the consequences of

natural disasters affecting the Rail Infrastructure;

- (ii) is consistent with the System Operating Parameters having regard to the inherent system capacity variability and the need to maintain latent capacity as a buffer for the variability as contemplated in the System Operating Parameters; and
- (iii) when viewed holistically, and subject to the Approved Maintenance Strategy and Budget applicable at that time (if any) or the Approved Maintenance Approach, as applicable, exercises the due care and skill that would be expected of an experienced manager and operator of rail infrastructure of the nature of the Rail Infrastructure who has regard to the following:
 - (A) seeking to ensure that Committed Capacity is delivered;
 - (B) appropriately balancing cost, reliability and performance (each in the long and short term) each in respect of the Rail Infrastructure; and
 - (C) coordinating outages with other Supply Chain Participants wherever reasonably possible with a view to maximising throughput,

(together comprising the **Maintenance Objectives**).

- (b) Aurizon Network must ensure that Maintenance Work is undertaken in the manner required under **clause 7A.11.1(a)** irrespective of the value of the direct maintenance cost allowance, Indirect Maintenance Cost allowance or operating cost allowance from time to time (provided, however, that cost is a matter to be had regard to in determining the standard of due care and skill under **clause 7A.11.1(a)(iii)(B)**).

7A.11.2 Composition of Rail Industry Group

- (a) Aurizon Network agrees to engage with the members of the Rail Industry Group for the purpose of this **clause 7A.11**.
- (b) Rail Industry Group membership will be open to all End Users, Access Seekers and Railway Operators and:
 - (i) all End Users, Access Seekers and Railway Operators that hold contractual rights to provide Train Services will be invited to attend and participate in meetings of the Rail Industry Group; and
 - (ii) End Users will be entitled to vote on matters to be determined by End Users in accordance with this Undertaking at meetings of the Rail Industry Group.
- (c) The purposes of the Rail Industry Group include, among other things:

- (i) considering and commenting on proposed Maintenance Strategies and Budgets and proposed Renewals Strategies and Budgets; and
 - (ii) communicating the outcome of voting by End Users on proposed Maintenance Strategies and Budgets and proposed Renewals Strategies and Budgets.
- (d) The Chair of the Rail Industry Group:
- (i) will be nominated by a special majority of members of the Rail Industry Group; and
 - (ii) may be removed by a simple majority of members of the Rail Industry Group.

7A.11.3 Approval of draft Maintenance Strategy and Budget and draft Renewals Strategy and Budget for a Coal System for a Year

- (a) This **clause 7A.11.3** sets out a process by which a draft Maintenance Strategy and Budget and a draft Renewals Strategy and Budget may be approved for each Year during the Term with effect from the Year ending 30 June 2021.
- (b) For the Year ending 30 June 2021 and each subsequent Year, by no later than 30 November of each prior Year Aurizon Network must provide the members of the Rail Industry Group and non-coal Access Holders and Customers with:
 - (i) Aurizon Network's draft Maintenance Strategy and Budget;
 - (ii) Aurizon Network's draft Renewals Strategy and Budget; and
 - (iii) subject to any confidentiality obligations and at the reasonable request of the Chair of the Rail Industry Group, such other information in relation to its draft Maintenance Strategy and Budget and its draft Renewals Strategy and Budget that the members of the Rail Industry Group, acting reasonably, may require.
- (c) Aurizon Network:
 - (i) may, and at the Chair of the Rail Industry Group's reasonable request will, present to the members of the Rail Industry Group its draft Maintenance Strategy and Budget and its draft Renewals Strategy and Budget;
 - (ii) will engage in good faith discussions with the members of the Rail Industry Group and non-coal Access Holders and Customers in relation to its draft Maintenance Strategy and Budget and its draft Renewals Strategy and Budget;
 - (iii) will provide updates to the members of the Rail Industry Group and non-coal Access Holders and Customers on matters referred to in **clause 7A.11.3(b)** if new information in

relation to those matters has become available between 30 November and the following 21 January; and

- (iv) may provide the members of the Rail Industry Group and non-coal Access Holders and Customers with proposed amendments to the draft Maintenance Strategy and Budget and the draft Renewals Strategy and Budget submitted to the members of the Rail Industry Group in accordance with **clause 7A.11.3(b)** to reflect the new information referred to in **clause 7A.11.3(c)(iii)**.

(d) Aurizon Network acknowledges that if:

- (i) the Chair of the Rail Industry Group requests information under **clause 7A.11.3(b)(iii)**; and
- (ii) Aurizon Network is restricted from disclosing the requested information to the members of the Rail Industry Group due to confidentiality restrictions,

then Aurizon Network:

- (iii) subject to the expert advisor signing a confidentiality agreement in favour of Aurizon Network, must use reasonable endeavours to disclose the information to an expert advisor engaged by the members of the Rail Industry Group; and
- (iv) acknowledges that the expert advisor may use the information to advise the members of the Rail Industry Group provided that the expert advisor does not disclose the Confidential Information to any members of the Rail Industry Group.

(e) Aurizon Network acknowledges that an expert advisor appointed by a Special Majority of End Users may attend meetings and discussions between Aurizon Network and the members of the Rail Industry Group in relation to Aurizon Network's draft Maintenance Strategy and Budget and draft Renewals Strategy and Budget.

(f) After considering the draft Maintenance Strategy and Budget and draft Renewals Strategy and Budget submitted to the members of the Rail Industry Group in accordance with **clause 7A.11.3(b)** and any presentation given by Aurizon Network, the Chair of the Rail Industry Group on behalf of a Special Majority of End Users may give Aurizon Network by 1 January following the submission a notice which specifies:

- (i) amendments to the draft Maintenance Strategy and Budget or the draft Renewals Strategy and Budget that the members of the Rail Industry Group consider reasonably necessary; and

- (ii) the reasons for the proposed amendments referred to in **clause 7A.11.3(f)(i)**.
- (g) Aurizon Network must, by 21 January following the notice given by the Chair of the Rail Industry Group under **clause 7A.11.3(f)**:
 - (i) consider any amendments notified by the Chair of the Rail Industry Group under **clause 7A.11.3(f)**;
 - (ii) promptly respond in writing to the amendments notified by the Chair of the Rail Industry Group and, if it does not accept any of the amendments, give reasons in writing for not doing so; and
 - (iii) provide to the Chair of the Rail Industry Group Aurizon Network's final draft Maintenance Strategy and Budget and its final draft Renewals Strategy and Budget.
- (h) Promptly following the receipt of Aurizon Network's final draft Maintenance Strategy and Budget and its final draft Renewals Strategy and Budget under **clause 7A.11.3(g)(iii)**, the Chair of the Rail Industry Group must put that Maintenance Strategy and Budget for a Coal System or the Renewals Strategy and Budget for a Coal System to a vote of the relevant End Users for each Coal System.
- (i) Aurizon Network acknowledges that the relevant End Users may have regard to the Maintenance Objectives when considering whether to approve Aurizon Network's final draft Maintenance Strategy and Budget.
- (j) The Chair of the Rail Industry Group must notify Aurizon Network and the QCA by no later than 14 February following receipt of Aurizon Network's final draft Maintenance Strategy and Budget and its final draft Renewals Strategy and Budget under **clause 7A.11.3(g)(iii)** that a Special Majority of End Users for that Coal System have, with respect to each Coal System, either:
 - (i) approved Aurizon Network's final draft Maintenance Strategy and Budget or Aurizon Network's final draft Renewals Strategy and Budget (as applicable) for the Coal System for the following Year; or
 - (ii) approved an alternative Maintenance Strategy and Budget or an alternative Renewals Strategy and Budget (as applicable) for the Coal System for the following Year; or
 - (iii) elected not to approve any Maintenance Strategy and Budget for the Coal System or Renewals Strategy and Budget for the Coal System for the following Year.
- (k) If Aurizon Network receives a notice from the Chair of the Rail Industry Group in respect of Aurizon Network's final draft Maintenance Strategy and Budget:

- (i) in accordance with **clause 7A.11.3(j)(i)**, Aurizon Network will implement the approved Maintenance Strategy and Budget for the Coal System for the applicable Year;
 - (ii) in accordance with **clause 7A.11.3(j)(ii)**, Aurizon Network will notify the Chair of the Rail Industry Group that Aurizon Network either:
 - (A) accepts the alternative Maintenance Strategy and Budget notified by the Chair of the Rail Industry Group under **clause 7A.11.3(k)(iii)**, in which case it will implement the alternative Maintenance Strategy and Budget for the Coal System for the applicable Year; or
 - (B) rejects the alternative Maintenance Strategy and Budget notified by the Chair of the Rail Industry Group, in which case Aurizon Network will submit its final draft Maintenance Strategy and Budget for the Coal System for the applicable Year to the QCA for approval and notify the Chair of the Rail Industry Group accordingly; or
 - (iii) in accordance with **clause 7A.11.3(j)(iii)**, in which case Aurizon Network will submit its final draft Maintenance Strategy and Budget for the Coal System for the applicable Year to the QCA for approval and notify the Chair of the Rail Industry Group accordingly.
- (l) The Maintenance Strategy and Budget for a Coal System for a Year:
- (i) approved and notified in accordance with **clause 7A.11.3(j)(i)**; or
 - (ii) accepted by Aurizon Network in accordance with **clause 7A.11.3(k)(ii)(A)**; or
 - (iii) approved by the QCA in accordance with **clause 7A.11.3(p)**,
- will be, for all purposes for this Undertaking, the Approved Maintenance Strategy and Budget for the relevant Coal System for the Year (**Approved Maintenance Strategy and Budget**).
- (m) If Aurizon Network receives a notice from the Chair of the Rail Industry Group in respect of Aurizon Network's draft Renewals Strategy and Budget:
- (i) in accordance with **clause 7A.11.3(j)(i)**, Aurizon Network will implement the approved Renewals Strategy and Budget for the Coal System for the Year;
 - (ii) in accordance with **clause 7A.11.3(j)(ii)**, Aurizon Network will notify the Chair of the Rail Industry Group that Aurizon Network either:

- (A) accepts the alternative Renewals Strategy and Budget notified by the Chair of the Rail Industry Group under **clause 7A.11.3(j)(ii)**, in which case it will implement the alternative Renewals Strategy and Budget for the Coal System for the Year; or
- (B) rejects the alternative Renewals Strategy and Budget notified by the Chair of the Rail Industry Group under **clause 7A.11.3(j)(ii)**, in which case Aurizon Network will implement its final draft Renewals Strategy and Budget for the Coal System for the Year and:
 - (1) notify the Chair of the Rail Industry Group accordingly; and
 - (2) submit its actual costs of implementing the Renewals Strategy and Budget for the Coal System for the Year for QCA approval in accordance with **clause 7A.11.6**; or
- (iii) in accordance with **clause 7A.11.3(j)(iii)**, Aurizon Network will implement its final draft Renewals Strategy and Budget and submit its actual costs of implementing the final draft Renewals Strategy and Budget for the Coal System for the Year for QCA approval in accordance with **clause 7A.11.6**.
- (n) The Renewals Strategy and Budget for a Coal System for a Year:
 - (i) approved and notified in accordance with **clause 7A.11.3(j)(i)**; or
 - (ii) accepted by Aurizon Network in accordance with **clause 7A.11.3(m)(ii)(A)**,
 will be, for all purposes for this Undertaking, the Approved Renewals Strategy and Budget for the relevant Coal System for the Year (**Approved Renewals Strategy and Budget**).
- (o) If **clause 7A.11.3(m)(ii)(B)** or **clause 7A.11.3(m)(iii)** applies, the final draft Renewals Strategy and Budget for the relevant Coal System will be, for all purposes for this Undertaking, the Renewals Strategy and Budget for that relevant Coal System that is implemented by Aurizon Network for the Year (**Interim Renewals Strategy and Budget**).
- (p) If Aurizon Network:
 - (i) submits its draft Maintenance Strategy and Budget for a Coal System for the Year to the QCA for approval in accordance with **clause 7A.11.3(k)(ii)(B)** or **clause 7A.11.3(k)(iii)**, the QCA will determine whether the activities and costs specified in that draft Maintenance Strategy and Budget are prudent and efficient and must approve either:

- (A) the draft Maintenance Strategy and Budget in the form submitted by Aurizon Network; or
 - (B) an alternative Maintenance Strategy and Budget determined by the QCA, identifying the differences between the alternative Maintenance Strategy and Budget approved by the QCA and the draft Maintenance Strategy and Budget submitted by Aurizon Network; or
- (ii) fails to submit its draft Maintenance Strategy and Budget for a Coal System for the Year to the QCA for approval in accordance with **clause 7A.11.3(k)(ii)(B)** or **clause 7A.11.3(k)(iii)**, the QCA will determine a Maintenance Strategy and Budget for the Year.
- (q) Aurizon Network may undertake:
- (i) Maintenance Work in a manner that is inconsistent with an Approved Maintenance Strategy and Budget or Approved Maintenance Approach (as applicable); and
 - (ii) Asset Replacement and Renewal work in a manner that is inconsistent with an Approved Renewals Strategy and Budget or an Interim Renewals Strategy and Budget (as applicable),
- provided that Aurizon Network (acting reasonably and for a purpose that is solely related to the safety, reliability or performance of the Rail Infrastructure (both in the long and short term)) considers that the inconsistency is prudent and efficient or necessary, including in order for Aurizon Network to respond to an emergency or natural disaster, but in doing so must have regard to System Operating Parameters (provided however that Aurizon Network must have regard to the inherent system capacity variability and the need to maintain latent capacity as a buffer for the variability as contemplated in the System Operating Parameters) and reliability, so as to seek to ensure that the Committed Capacity is delivered.
- (r) If:
- (i) a ballot of the End Users of a Coal System is not undertaken in respect the final draft Maintenance Strategy and Budget or the final draft Renewals Strategy and Budget provided to the Chair of the Rail Industry Group under **clause 7A.11.3(g)(iii)** by the time that the Chair of the Rail Industry Group is required to notify Aurizon Network and the QCA under **clause 7A.11.3(j)**; or
 - (ii) the Chair of the Rail Industry Group does not notify Aurizon Network and the QCA of the outcome of a ballot of End

Users for a Coal System within the time required under, and otherwise in accordance with, **clause 7A.11.3(j)**,

then:

- (iii) the End Users for the relevant Coal System will be deemed to have elected not to approve the final draft Maintenance Strategy and Budget or the final draft Renewals Strategy and Budget (as applicable) provided to the Chair under **clause 7A.11.3(g)(iii)** for that Coal System for the following Year; and
- (iv) the Chair of the Rail Industry Group will be taken to have notified Aurizon Network of such election not to approve the final draft Maintenance Strategy and Budget or the final draft Renewals Strategy and Budget (as applicable) under **clause 7A.11.3(j)(iii)**.

7A.11.4 *Submission of proposed Maintenance Indicator and Capital Indicator for annual review of Reference Tariffs*

- (a) Subject to **clause 7A.11.4(b)**, within 14 days of a Maintenance Strategy and Budget for a Coal System for a Year being approved or accepted as the Approved Maintenance Strategy and Budget for the Coal System for the Year as contemplated by **clause 7A.11.3(l)**:
 - (i) Aurizon Network must submit to the QCA a proposed Maintenance Indicator for the Year that is (to the extent it relates to the relevant Coal System) consistent with the Approved Maintenance Strategy and Budget for the Coal System for the Year; and
 - (ii) to the extent the QCA determines that the proposed Maintenance Indicator (to the extent it relates to the relevant Coal System) submitted by Aurizon Network to the QCA for a Year is consistent with the Approved Maintenance Strategy and Budget for the Coal System for the Year, the QCA will approve the Maintenance Indicator.
- (b) If by 14 February of a Year, the Maintenance Strategy and Budget for a Coal System has not been approved for the following Year then Aurizon Network must submit to the QCA a Maintenance Indicator for the Coal System for the purpose of the annual review of Reference Tariffs under **clause 4 of Schedule F** for review by the QCA.
- (c) Subject to **clause 7A.11.4(d)**, within 14 days of a Renewals Strategy and Budget for a Coal System for a Year being approved or accepted as the Approved Renewals Strategy and Budget for the Coal System for the Year as contemplated by **clause 7A.11.3(n)** then:
 - (i) Aurizon Network must submit to the QCA a proposed Capital Indicator for the Year that is (to the extent it relates to the relevant Coal System) consistent the Approved Renewals Strategy and Budget for the Coal System for the Year; and

- (ii) to the extent the QCA determines that the proposed Capital Indicator (to the extent it relates to the relevant Coal System) submitted by Aurizon Network to the QCA for a Year is consistent with the Approved Renewals Strategy and Budget for the Coal System for the Year, the QCA will approve the Capital Indicator.
- (d) If by 14 February of a Year there is no Approved Renewals Strategy and Budget for a Coal System for the following Year then Aurizon Network must submit to the QCA a Capital Indicator for the Coal System for the purpose of the annual review of Reference Tariffs under **clause 4** of **Schedule F** for review by the QCA.
- (e) If Aurizon Network fails to comply with this **clause 7A.11.4** then the QCA will determine the Maintenance Indicator or the Capital Indicator, as applicable.

7A.11.5 QCA approval of actual maintenance costs

- (a) There will be no Maintenance Costs Claim for the Year ending 30 June 2018.
- (b) The QCA must with respect to the direct maintenance cost allowance:
 - (i) for the Central Queensland Coal Network for the Year ending 30 June 2019 approve the lower of:
 - (A) the actual Direct Maintenance Costs incurred by Aurizon Network with respect to the Central Queensland Coal Network during the Year; and
 - (B) the aggregate Direct Maintenance Cost Allowance with respect to the Central Queensland Coal Network in the QCA's 2018 Decision.
 - (ii) for each Coal System for the Year ending 30 June 2020 approve the lower of:
 - (A) the actual Direct Maintenance Costs incurred by Aurizon Network with respect to the Coal System during the Year; and
 - (B) the Direct Maintenance Cost allowance for the Coal System in the QCA Consolidation DAAU Decision.
- (c) With effect from 30 September 2019, by 30 September each Year (or such later time as reasonably requested by Aurizon Network and agreed by the QCA) in respect of the Year ending on the previous 30 June, Aurizon Network must submit to the QCA:
 - (i) the actual maintenance costs incurred by Aurizon Network in respect of the relevant Year, including:
 - (A) all items in the Approved Maintenance Strategy and Budget that it has not undertaken; and

- (B) all items in respect of which it has spent at least \$2 million less than the budgeted amount;
- (ii) the scope of Maintenance Work undertaken during the relevant Year; and
- (iii) the procurement strategy and methodology used by Aurizon Network with respect to the Maintenance Work undertaken during the relevant Year,

for the purpose of calculating the Adjusted Allowable Revenue under **clauses 4.3(c) and 4.3(ca) of Schedule F**,

(Maintenance Costs Claim).

- (d) The QCA must determine the extent to which the Maintenance Costs Claim is consistent with the Approved Maintenance Strategy and Budget for each Coal System for the Year (if any).
- (e) The QCA must give the members of the Rail Industry Group and other stakeholders a reasonable opportunity to make submissions to the QCA on the extent to which the Maintenance Costs Claim is inconsistent with the Approved Maintenance Strategy and Budget for each Coal System for the Year (if any).
- (f) To the extent that the Maintenance Costs Claim for a Year is consistent with the Approved Maintenance Strategy and Budget for the Year for a Coal System (being that there is not a difference in a material respect to the Approved Maintenance Strategy and Budget for the Coal System for that Year):
 - (i) the End Users are deemed to support the relevant elements of the Maintenance Costs Claim; and
 - (ii) the QCA will:
 - (A) approve the Maintenance Costs Claim; and
 - (B) consider:
 - (1) any departures from the costs or maintenance activities specified in the Approved Maintenance Strategy and Budget in accordance with **clauses 7A.11.5(h) and 7A.11.5(i)**;
 - (2) any item in a Maintenance Costs Claim which is at least \$2 million more than the corresponding item in the Approved Maintenance Strategy and Budget for a Coal System;
 - (3) any item in a Maintenance Costs Claim which is at least \$2 million less than the corresponding item in the Approved

Maintenance Strategy and Budget for a Coal System;

- (4) any item in an Approved Maintenance Strategy and Budget for a Coal System which has a value of at least \$2 million and which Aurizon Network has failed to undertake.
- (g) To the extent that a Maintenance Costs Claim for a Year from the Year ending 30 June 2021 and each subsequent Year, involves costs or maintenance activities that are different in a material respect from the Approved Maintenance Strategy and Budget for a Coal System for the Year, the End Users may make submissions to the QCA in relation to the differences.
- (h) To the extent the costs incurred or maintenance activities performed by Aurizon Network are different in a material respect (on the basis of the differences referred to in **clauses 7A.11.5(f)(ii)(B)(2) to (4)**) to the Approved Maintenance Strategy and Budget for a Coal System for the Year, the QCA will determine whether those costs and activities specified in the Maintenance Costs Claim are prudent and efficient.
- (i) The QCA must approve the costs that are different in a material respect in a Maintenance Costs Claim to the extent those costs specified in the Maintenance Costs Claim are prudent and efficient. In determining whether costs and practices are prudent and efficient, the QCA may have regard to Aurizon Network's obligations under **clauses 7A.11.1(a)(iii)(A) and 7A.11.1(a)(iii)(C)**.

7A.11.6 QCA approval of actual Asset Replacement and Renewal Expenditure

- (a) With effect from 31 October 2020, by 31 October each Year (or such later time as reasonably requested by Aurizon Network and agreed by the QCA) in respect of the Year ending on the previous 30 June, Aurizon Network must submit to the QCA:
 - (i) the Asset Replacement and Renewal Expenditure for the relevant Year;
 - (ii) the scope of Asset Replacement and Renewal work undertaken during the relevant Year; and
 - (iii) the procurement strategy and methodology used by Aurizon Network with respect to the Asset Replacement and Renewal work undertaken during the relevant Year,

(Renewals Capex Claim).
- (b) Where there is an Approved Renewals Strategy and Budget for a Coal System for a Year:
 - (i) the QCA must determine the extent to which the Renewals Capex Claim is consistent with the applicable Approved Renewals Strategy and Budget;

- (ii) the QCA must give the members of the Rail Industry Group and other stakeholders a reasonable opportunity to make submissions to the QCA on the extent to which the Renewals Capex Claim is inconsistent with the applicable Approved Renewals Strategy and Budget;
- (iii) to the extent that the Renewals Capex Claim for a Year is consistent with the applicable Approved Renewals Strategy and Budget:
 - (A) the relevant End Users are deemed to support the relevant elements of the Renewals Capex Claim; and
 - (B) the QCA will approve the Renewals Capex Claim; and
- (iv) to the extent that a Renewals Capex Claim for a Year departs from the applicable Approved Renewals Strategy and Budget:
 - (A) the QCA will determine whether those additional costs specified in the Renewals Capex Claim are prudent and efficient; and
 - (B) the QCA must approve the additional costs in a Renewals Capex Claim to the extent those additional costs specified in the Renewal Capex Claim are prudent and efficient.
- (c) Where there is no Approved Renewals Strategy and Budget for a Coal System for the Year the QCA must approve a Renewals Capex Claim to the extent that the expenditure specified in the Renewals Capex Claim is prudent and efficient.

7A.11.7 Asset Replacement and Renewal Expenditure

- (a) Subject to:
 - (i) the Approved Renewals Strategy and Budget or the Interim Renewals Strategy and Budget (as applicable) at the relevant time (if any);
 - (ii) the Approved Maintenance Strategy and Budget at the relevant time (if any);
 - (iii) any variations to the Approved Maintenance Strategy and Budget in accordance with **clause 7A.11.1(a)(i)(D)**; and
 - (iv) Aurizon Network's right to undertake Asset Replacement and Renewal work in a manner that is inconsistent with the Approved Renewals Strategy and Budget or Interim Renewals Strategy and Budget under **clause 7A.11.3(q)**,

Aurizon Network acknowledges and agrees that it must fund all Asset Replacement and Renewal Expenditure to the extent

necessary in order for Aurizon Network to deliver the Committed Capacity during the Term.

- (b) Aurizon Network acknowledges that:
 - (i) a breach of **clause 7A.11.7(a)** is an 'AN Performance Breach' for the purposes of **clause 7A.6** and that **clause 7A.6** applies with respect to such 'AN Performance Breach'; and
 - (ii) Aurizon Network is not liable to an End User for any loss suffered or incurred by that End User arising from a breach by Aurizon Network of **clause 7A.11.7(a)** except to the extent of:
 - (A) any Rebate that Aurizon Network may be liable to pay as a result of such breach under **clause 7A.6**, (or would be liable to pay but for the End User's failure to provide the written undertaking contemplated by **clause 7A.6(c)(i)**); and
 - (B) any other liability that Aurizon Network may have to the End User in connection with a matter referred to in any of **clauses 7A.6(c)(ii)(D)**, **7A.6(c)(ii)(E)** and **7A.6(c)(ii)(F)**.

7A.11.8 End User Voting Rights (Network) and End User Voting Rights (Coal System)

- (a) Aurizon Network must provide to the Independent Expert such information (including as to the volume of Access Rights for each End User) that the Independent Expert may require in order to determine the End User Voting Rights (Network) and End User Voting Rights (Coal System) for each End User.
- (b) The Independent Expert:
 - (i) may verify with each End User that the information provided by Aurizon Network in respect of the End User is correct; and
 - (ii) must notify the Chair of the Rail Industry Group and Aurizon Network the End User Voting Rights (Coal System) and End User Voting Rights (Network) for each End User.

7A.12 Amendment to Access Agreements

As soon as is reasonably practicable after the System Operating Parameters are published by the Independent Expert, Aurizon Network agrees to amend any Access Agreement to effect any changes requested by the Access Holder or End User that are consistent with and reflect:

- (a) the System Operating Parameters as determined by the Independent Expert; and
- (b) this Undertaking,

provided that, the amendments to the Access Agreement will not take effect unless and until any corresponding Train Operations Deed is also amended in a consistent manner.

7A.13 Non-coal carrying Train Services

7A.13.1 *Utilisation of Rail Infrastructure for non-coal carrying Train Services*

- (a) In scheduling Train Services, Aurizon Network must use reasonable endeavours to plan and implement Operational Constraints (including in relation to Maintenance Works and Infrastructure Enhancements) so as to minimise disruption to the operation of non-coal carrying Train Services, including to minimise disruption to Train Service Entitlements and Operational Rights.
- (b) The obligation in **clause 7A.13.1(a)** to use reasonable endeavours includes an obligation for Aurizon Network to bear the reasonable costs (if any) associated with planning and implementing the relevant Operational Constraints so as to minimise disruption to the operation of non-coal carrying Train Services.
- (c) The obligation in **clause 7A.13.1(a)** to use reasonable endeavours includes an obligation to provide reasonable notice of Operational Constraints and, where possible, to provide reasonable alternative Scheduled Times for affected non-coal carrying Train Services to the relevant Access Holder or where nominated, the relevant Train Operator having regard to the reasonable requirements of that Access Holder or the relevant Train Operator.
- (d) Aurizon Network will not be taken to be liable for a breach of **clause 7A.13.1(a)** where the relevant parties have agreed to limit or exclude that liability under a relevant Access Agreement or Train Operations Deed entered into after the Approval Date.
- (e) Aurizon Network may impose Operational Constraints as it considers necessary, acting reasonably, for the protection of any person or any property (including Rail Infrastructure) provided that Aurizon Network has used reasonable endeavours to comply with **clause 7A.13.1(a)**.
- (f) Nothing in **clause 7A.13.1(a)** limits provisions of this Undertaking relating to Emergency Possessions, Urgent Possessions or Safety Standards.
- (g) If there is any inconsistency or ambiguity between the provisions of this **clause 7A.13.1(a)** and any other provisions of this **Part 7A** or of the Network Management Principles, **clause 7A.13.1(a)** will prevail to the extent of the inconsistency or ambiguity.

Part 8: Network development and Expansions

8.1 Overview

This **Part 8** sets out various provisions relating to the creation of new Rail Infrastructure, in particular:

- (a) **clause 8.2** sets out general principles regarding limitations on Aurizon Network's rights and obligations to fund, construct or permit the creation of new Rail Infrastructure;
- (b) **clause 8.3** sets out principles in relation to Aurizon Network's undertaking of Concept Studies, Pre-feasibility Studies and Feasibility Studies;
- (c) **clause 8.4** sets out principles in relation to the way in which Concept Studies, Pre-feasibility Studies and Feasibility Studies are to be funded;
- (d) **clause 8.5** sets out how Capacity is provisionally allocated if a Study Funding Agreement for a Feasibility Study becomes unconditional;
- (e) **clause 8.6** sets out the ability for third parties to step into a Concept Study, Pre-feasibility Study or Feasibility Study in certain circumstances;
- (f) **clause 8.7** sets out general principles in relation to the funding of Expansions;
- (g) **clause 8.8** describes how Users may fund all or part of an Expansion; and
- (h) **clause 8.9** sets out provisions in relation to Capacity Shortfalls, Expansion Capacity Deficits and Access Agreements which are conditional on Expansions and Aurizon Network's obligation to deliver a minimum level of Capacity out of an Expansion.

8.2 General principles

8.2.1 *Rights and obligations to fund, construct or permit the creation of new Rail Infrastructure*

- (a) Subject to **clauses 8.2.1(b), 8.2.1(c), 8.2.1(d), 8.7** and **Part 9**, nothing in this Undertaking:
 - (i) obliges Aurizon Network to fund, construct or permit an Expansion, or to agree to do so; or
 - (ii) prevents Aurizon Network from agreeing (in its absolute discretion), or deciding itself, to fund, construct or permit an Expansion, or any part thereof.
- (b) Aurizon Network:
 - (i) may subject to **clause 8.2.1(b)(ii), clause 8.2.1(r)** and **clause 8.7**, at its discretion, fund all or part of the

construction of any Expansion and must provide notice of that decision (including details of the amount of funding) to the parties requesting the Expansion in accordance with this **Part 8**. The delivery of that notice by Aurizon Network will create a funding obligation on Aurizon Network to provide the relevant funding for the purposes of this Undertaking;

- (ii) commits to fund the Committed Expansion Funding Amount on Expansions in each Year with effect from 1 July 2019, provided however that:
- (A) the Committed Expansion Funding Amount will be subject to indexation each Year, commencing on 1 July 2020, in accordance with CPI increases (if any) published for the 12 month period ending in the Quarter commencing 1 January immediately preceding the indexation date;
- (B) where in respect of a Year (**Relevant Year**) any of the Committed Expansion Funding Amount for the Relevant Year (as increased in accordance with **clause 8.2.1(b)(ii)(A)** and this **clause 8.2.1(b)(ii)(B)**) is not used by Aurizon Network to fund Expansions in the Relevant Year (**Unexpended Portion**), then:
- (1) the Committed Expansion Funding Amount for the following Year will be deemed to be the sum of:
- the Committed Expansion Funding Amount (as increased in accordance with **clause 8.2.1(b)(ii)(A)**); and
 - the Unexpended Portion for the Relevant Year; and
- (2) Aurizon Network commits to fund the Committed Expansion Funding Amount for the following Year as calculated in accordance with **clause 8.2.1(b)(ii)(B)(1)**;
- (C) **clause 8.2.1(b)(ii)** will apply to each Year from 1 July 2019 until the Terminating Date;
- (D) the Committed Expansion Funding Amount will only be used to fund a proposed Expansion which, once completed, will increase the Capacity of a Coal System for the benefit of more than one Access Seeker, Customer or Access Holder and not solely for the benefit of the Access Seeker whose application for access resulted in the need for the proposed Expansion;

- (E) nothing in this **clause 8.2.1(b)(ii)** affects the application of the balance of this **Part 8** or Schedule E;
 - (F) the amount of the Committed Expansion Funding Amount (including any deemed amount pursuant to **clause 8.2.1(b)(ii)(B)**) used by Aurizon Network to fund Expansions in a Year will form part of the Regulatory Asset Base in that Year and will not require separate approval for inclusion in the Regulatory Asset Base by the QCA; and
 - (G) notwithstanding any other provision of this Undertaking and notwithstanding the nature of the Expansion to which the Committed Expansion Funding Amount is applied, the amount of the Committed Expansion Funding Amount provided by Aurizon Network in a Year will be subject to Socialisation to apply to all Expansion Stakeholders (as those terms are defined in **clause 6.4.1(e)** of this Undertaking).
- (c) Notwithstanding any other provision of **Part 7A** or this **Part 8**, Aurizon Network is obliged to construct or permit an Expansion only to the extent that:
- (i) Aurizon Network is satisfied (acting reasonably) that the Expansion is technically and economically feasible and consistent with the safe and reliable operation of the Rail Infrastructure.

The proposed Expansion is deemed to be technically and economically feasible and consistent with the safe and reliable operation of the Rail Infrastructure unless:

 - (A) within ten (10) Business Days after entry into a relevant Study Funding Agreement for a Feasibility Study for that Expansion, Aurizon Network has notified the Access Seekers selected to utilise an Expansion in accordance with this **Part 8** that the Expansion does not satisfy those requirements; or
 - (B) despite Aurizon Network not having notified the relevant Access Seekers, there has been a material change so that the proposed Expansion no longer satisfies those requirements (in which case Aurizon Network will notify the relevant Access Seekers of the material change and the basis of its decision not to construct or permit the Expansion);
 - (ii) the Expansion is fully funded through one of the following means:

- (A) Aurizon Network is obliged by this Undertaking to fund the Expansion or, where Aurizon Network is not obliged by this Undertaking, it agrees (at its discretion) to fund the Expansion;
 - (B) Expansion Funders agree to fund the Expansion in accordance with a User Funding Agreement for the Expansion; or
 - (C) Expansion Funders partially fund the Expansion under a User Funding Agreement and the remainder of the funding is provided by Aurizon Network;
- (iii) Aurizon Network and all other relevant parties have entered into User Funding Agreements, Access Conditions and/or an Access Agreement (as the case may be) and such agreements are, or have become, unconditional in accordance with their terms (except for the delivery of the Capacity being generated by the Expansion); and
 - (iv) unless otherwise agreed by Aurizon Network, the Expansion (whether or not funded in whole or part by a person other than Aurizon Network) is or will be leased from the State, an Authority or a User Funding Trustee or owned, and in either case operated, by Aurizon Network.
- (d) Subject to **clause 8.2.1(b)(ii)(G)**, the pricing principles to apply to an Expansion are set out in **Part 6** and nothing in this **Part 8** limits the application of **Part 6**.
 - (e) Notwithstanding any other provision of this **Part 8** and **Part 6**, to the extent that Aurizon Network is obliged to undertake asset replacement works in order to meet its obligations under an Access Agreement or this Undertaking, Aurizon Network will be responsible for the funding of Asset Replacement and Renewal Expenditure as well as undertaking or procuring the undertaking of the asset replacement covered by that funding. (Aurizon Network's obligations to provide that funding and to undertake or procure the asset replacement will be governed by the terms of the relevant Access Agreement or this Undertaking).
 - (f) Aurizon Network is not obliged to fund or construct a Customer Specific Branch Line (subject to its obligations in relation to Connecting Infrastructure). However, nothing in this Undertaking prevents Aurizon Network and the Customer seeking to construct the Customer Specific Branch Line from agreeing that Aurizon Network may do so.
 - (g) Aurizon Network's obligations in respect of Connecting Infrastructure are set out in **Part 9** and nothing in this **Part 8** limits Aurizon Network's obligations under **Part 9**.

- (h) Aurizon Network will not unnecessarily or unreasonably delay any Expansion that it is obliged to construct in accordance with this Undertaking provided that after any relevant agreement with any Access Seeker, Access Holder, Customer or Expansion Funder (as applicable), including any relevant User Funding Agreement, is executed for that Expansion then Aurizon Network's obligations in relation to any delay are solely governed by that agreement.
- (i) Subject to **clause 8.9.1**, Aurizon Network must, in accordance with **Part 4**, enter into Access Agreements with relevant Access Seekers for Capacity to be created by an Expansion.
- (j) It is acknowledged that:
 - (i) Aurizon Network and an Access Seeker (or, as applicable, Customer) may agree (in each party's absolute discretion) to enter into arrangements relating to, or in connection with, funding, constructing or permitting an Expansion or Customer Specific Branch Line necessary to provide additional Capacity required to grant Access Rights requested by that Access Seeker (or, as applicable, Customer);
 - (ii) Aurizon Network and an Access Seeker (or, as applicable, Customer) may agree that Aurizon Network will fund and construct a Customer Specific Branch Line; and
 - (iii) Aurizon Network may elect to otherwise invest in the Rail Infrastructure on its own account,
 provided that any such agreement or election must not:
 - (iv) in any way unfairly prejudice or unfairly disadvantage another Access Seeker (or, as applicable, Customer) who is seeking Capacity to be created by an Expansion or Customer Specific Branch Line under this **Part 8**; or
 - (v) affect the priority of allocation of Capacity between Access Seekers that would otherwise apply under Part 7 or **clause 8.5**.
- (k) To the extent that this Undertaking is inconsistent with a User Funding Agreement or a Studies Funding Agreement for a Pre-feasibility Study or a Feasibility Study:
 - (i) subject to **clause 8.2.1(k)(ii)**, the User Funding Agreement or Studies Funding Agreement (as applicable) will prevail to the extent of that inconsistency (but only as between Aurizon Network and the other parties to those agreements, any relevant Access Seeker (if its Customer is one of those parties) and any relevant Customer (if its Access Seeker is one of those parties)); and

- (ii) if the inconsistency relates to the right or ability of a party to make submissions, provide information or refer disputes to the QCA, this Undertaking will prevail.
- (l) Except where set out to the contrary in this **Part 8**, the person responsible for:
 - (i) developing the design and considering the scope of work to deliver the Capacity required by any Expansion that is necessary in order to provide any Access Rights requested by an Access Seeker must be Aurizon Network;
 - (ii) confirming that the design will deliver the Capacity required by any Expansion that is necessary in order to provide any Access Rights requested by an Access Seeker must be the Independent Expert;
 - (iii) construction of any Expansion must be Aurizon Network.
- (m) In this **Part 8**, where an Access Seeker has submitted two or more Access Applications which differ in respect of origins/destinations, quantum of capacity, commencement dates or other capacity requirements in relation to a particular Expansion, Aurizon Network must:
 - (i) treat each Access Application as a separate Access Application and as if each were lodged by a separate Access Seeker; and
 - (ii) ensure that the Access Applications do not distort any analysis of capacity requirements for the purposes of any Capacity Analysis, Demand Assessment, Concept Study, Pre-feasibility Study or Feasibility Study as a result of being treated as separate Access Applications.
- (n) This **Part 8** applies to Expansions for the purpose of providing additional Access to both coal carrying Train Services and non-coal carrying Train Services.
- (o) Except where set out to the contrary in this **Part 8**, Aurizon Network will not discriminate in the performance of its obligations and the exercise of its rights in this **Part 8** as between Access Seekers (or, as applicable, Customers) on the basis of the identity of the funder of a Pre-feasibility Study, a Feasibility Study or an Expansion. For example, Aurizon Network will not provide an Access Seeker (or, as applicable, Customer) with priority in the allocation of Capacity in respect of an Expansion on the basis that Aurizon Network is providing funding for the Expansion over another Access Seeker (or as applicable, Customer) with a different source of funding.
- (p) In this **Part 8**, if the Access Seeker is intending to use Access Rights that may be developed as a result of an Expansion for another person (in that Access Seeker's capacity as a Railway Operator):

- (i) the Access Seeker must be acting on behalf of a Customer or Customers identified to Aurizon Network for all of the Access Rights sought by the Access Seeker and Aurizon Network must make reasonable inquiries as to the identity of the Customer(s) in accordance with the requirements of this **Part 8**;
- (ii) a reference to the Access Seeker also includes a reference to its Customer; and
- (q) Aurizon Network and the Access Seeker must copy the Customer on any correspondence or notices between them.
- (r) Prior to Aurizon Network agreeing to fund, construct or permit an Expansion under this **Part 8**, Aurizon Network must:
 - (i) consider (acting reasonably and in good faith) whether the need for an Expansion could be avoided by the resumption of Access Rights in accordance with **clause 7.6** or pursuant to the relevant Access Holder's Access Agreement; and
 - (ii) if it considers the need for an Expansion could be avoided by the resumption of Access Rights, and a Resumption Trigger Event (or the resumption trigger event under the Access Agreement) has occurred, follow the process (acting reasonably and in good faith) under either **clause 7.6** or pursuant to the relevant Access Holder's Access Agreement (as applicable).

8.2.2 Disputes under Part 8

- (a) For clarity, an Access Seeker, proposed Pre-feasibility Funder, proposed Feasibility Funder, proposed Expansion Funder (to the extent that such proposed Pre-feasibility Funder, proposed Feasibility Funder or proposed Expansion Funder is an Access Seeker, Customer or Train Operator) (as applicable) may dispute any matter that may arise under this **Part 8**, (other than a decision by Aurizon Network in accordance with this Undertaking that it will not fund an Expansion), or a party's refusal to vary the terms of a Standard Agreement in accordance with **clause 11.1.1(b)**, including:
 - (i) any decision made by Aurizon Network under **Part 8**;
 - (ii) the completion of schedules in, or the annexures of, a Studies Funding Agreement where the relevant Studies Funding Agreement is in the form of the Standard Studies Funding Agreement;
 - (iii) the unsuccessful negotiation of a User Funding Agreement in accordance with **clause 8.8.1(a)(ii)**;
 - (iv) the adequacy or otherwise of any report prepared by Aurizon Network under **Part 8**;

- (v) whether Aurizon Network has acted reasonably or in good faith in applying **Part 8** including whether Aurizon Network has acted in good faith in accordance with **8.7.1(n)**; and
 - (vi) whether Aurizon Network has complied with its obligations, by referring the matter to the QCA.
- (b) Any dispute referred to in **clause 8.2.2(a)** must be:
- (i) referred to the QCA to be determined in accordance with **clause 11.1.5**; and
 - (ii) notified to Aurizon Network (as applicable);
 - (A) within ten (10) Business Days of the notification of the relevant decision by Aurizon Network;
 - (B) within twenty (20) Business Days of the date of receipt of the relevant report from Aurizon Network;
 - (C) within twenty (20) Business Days of the date of receipt of a Capacity Assessment Notice; or
 - (D) at any time in respect of completion of schedules in a Studies Funding Agreement or;
 - (E) at any time in respect of any other dispute referred to in **clause 8.2.2(a)**.
- (c) A dispute notified under **clause 8.2.2(a)** is a Dispute for the purpose of **clause 11.1**.
- (d) On receipt of a notice under **clause 8.2.2(b)**, Aurizon Network must:
- (i) promptly notify (with an outline of the matters in dispute and the identity of the initial parties to the Dispute) each Access Seeker (or where applicable, Customer) that is either affected by the decision made by Aurizon Network or has indicated an interest in the Expansion the subject of the Dispute that a Dispute has been referred to the QCA;
 - (ii) use its best endeavours to promptly identify all other parties that should be bound by the outcome of the Dispute and provide those parties with notice of the existence of the Dispute including an outline of the matters in dispute and the identity of the initial parties to the Dispute; and
 - (iii) provide the QCA with a list of the parties to whom notice of the Dispute has been given under this **clause 8.2.2(d)**.
- (e) Any party receiving notice of the Dispute under **clause 8.2.2(d)** may contact the QCA to seek to be heard on the Dispute.
- (f) Any party that did not receive a notice of the Dispute under **clause 8.2.2(d)** but believes it should have received that notice may also contact the QCA to seek to be heard on the Dispute.

- (g) The QCA's determination may include alternative conclusions (including where the adequacy of a report is in dispute) and will be binding on all of the Access Seekers the subject of the relevant Demand Assessment, Concept Study, Pre-feasibility Study, Feasibility Study or User Funding Agreement negotiation (as applicable) and on Aurizon Network.
- (h) Aurizon Network must not effect any decision made under this **Part 8** until:
 - (i) the relevant period for disputing that decision has expired and the decision has not been referred to the QCA; or
 - (ii) if the decision is the subject of a dispute, the QCA has determined that Aurizon Network may proceed with the relevant decision.

8.2.3 *Interdependent and sequential nature of Expansions*

- (a) The following principles relate to the interdependent and sequential nature of Expansions:
 - (i) for any Coal System there may be multiple Expansions that incrementally build on each other in sequence to increase the Capacity of that Coal System;
 - (ii) as the Expansions are sequential, Expansions later in the sequence will assume the satisfactory completion of, and delivery of outcomes for, Expansions earlier in the sequence;
 - (iii) to the extent that events or circumstances affect an Expansion in the sequence (for example, by it being delayed, not progressing or not delivering the expected outcomes), then Expansions later in the sequence may also be affected and will need to be reviewed to take into account the effect of those events or circumstances;
 - (iv) similarly, to the extent that any Coal Systems overlap, Expansions on one Coal System may affect Expansions on another Coal System; and
 - (v) subject to **clause 8.2.3(b)**, until:
 - (A) the Access Seekers (or, as applicable, their Customers) for any earlier Expansion in a sequence of Expansions have entered into Access Agreements or User Funding Agreements, as applicable, (**Earlier Expansion Agreements**) in respect of that earlier Expansion; and
 - (B) such agreements are or have become unconditional,

Aurizon Network and Access Seekers (or, as applicable, their Customers) for any later Expansion in a sequence of Expansions must not enter into Access Agreements or User Funding Agreements, as applicable, (**Later Expansion Agreements**) in respect of that later Expansion except where the Later Expansion Agreement is conditional on the requirements in **clauses 8.2.3(a)(v)(A)** and **8.2.3(a)(v)(B)** being satisfied for the Later Expansion Agreement to come into full effect.

- (b) Where different Access Seekers have been identified to be provided with Access through sequential proposed Expansions and either:
- (i) an Access Seeker allocated to a later Expansion in the sequence of Expansions has advised Aurizon Network that it will have an unconditional Access Agreement or a User Funding Agreement on a date Aurizon Network (acting reasonably) determines is at least six (6) Months earlier than the date on which an Access Seeker allocated to an earlier Expansion in the sequence of Expansions is likely to have an unconditional Access Agreement or User Funding Agreement, as applicable; or
 - (ii) there has been a delay of at least six (6) Months in the expected date on which an Access Seeker allocated to an earlier Expansion in the sequence of Expansions can fully utilise the relevant Access Rights under that proposed Expansion (taking into account the matters in **clause 8.4.3(a)(ii)** and ramp up profiles notified by the Access Seeker to Aurizon Network) and another Access Seeker allocated to a later Expansion in the sequence of Expansions is expected to be able to fully utilise the Access Rights created by the earlier Expansion at least ninety (90) days earlier than the delayed Access Seeker,

Aurizon Network may, acting reasonably and in good faith, reallocate Capacity proposed to be created by the sequential Expansions between those Access Seekers but only to the extent that the reallocation does not prevent:

- (iii) the relevant Expansions from achieving the dates for practical completion or dates for commissioning agreed for each Expansion; and
 - (iv) the Access Seeker allocated to the earlier Expansion in the sequence of Expansions obtaining its Access Rights at the time agreed by Aurizon Network and that Access Seeker.
- (c) If Aurizon Network intends to reallocate Capacity to Access Seekers under **clause 8.2.3(b)**, it must give reasonable prior notice to each Access Seeker affected by the reallocation, including sufficient grounds for the reallocation to permit the Access Seeker to

understand Aurizon Network's decision but without disclosing information that is sensitive to the other Access Seekers (or Customer, if any) and all details of the intended reallocation.

- (d) If the majority of Access Seekers in a later Expansion in a sequence (by reference to the number of Train Paths sought by those Access Seekers), consider that the circumstances described in **clause 8.2.3(b)(i)** or **clause 8.2.3(b)(ii)** exist, those Access Seekers may notify Aurizon Network of that belief and the grounds for that belief. On receipt of a notice under this **clause 8.2.3(d)**, Aurizon Network must reasonably consider whether a reallocation should be made under **clause 8.2.3(b)**.

8.2.4 *Determination of sufficient demand for an Expansion*

- (a) Without limiting Aurizon Network's ability to conduct a Demand Assessment for an Expansion of its own volition, Aurizon Network must:
 - (i) promptly (and in any case within ten (10) Business Days of the relevant event referred to below) commence a Demand Assessment for an Expansion where:
 - (A) the operator of an existing or proposed coal terminal formally advises Aurizon Network that it has commenced a process to expand an existing coal terminal or to build a new coal terminal which is likely to create demand for additional below rail capacity; or
 - (B) an Access Seeker submits an Access Application for Access that Aurizon Network concludes cannot be satisfied without Aurizon Network undertaking an Expansion and that Access Seeker requests in writing that Aurizon Network carry out a Concept Study for that Expansion; and
 - (ii) provide the QCA, each relevant Access Seeker and, if relevant, the proponent of the coal terminal with a copy of a detailed report of the results of its Demand Assessment within twenty (20) Business Days after the commencement of the study (except where a Dispute arises in respect of the information being sought by Aurizon Network for the purposes of Demand Assessment, in which case the period is extended by the number of Business Days between (and including) the day on which the Dispute is referred to the QCA and the day on which the QCA's determination is published).
- (b) Where Aurizon Network undertakes a Demand Assessment for an Expansion it must do so using the most appropriate means and any

information it considers relevant (in each case acting reasonably) in the circumstances including as follows:

- (i) the Access Applications it has received;
- (ii) liaison and consultation with participants in Supply Chains and Supply Chain Groups relating to each affected Coal System;
- (iii) consultation with the Independent Expert;
- (iv) analysis or advice on demand or capacity submitted by participants in relevant Supply Chain Groups; and
- (v) analysis or advice from relevantly experienced expert advisors, if necessary.

Aurizon Network agrees not to seek information from Access Seekers or Prospective Access Seekers under this **clause 8.2.4(b)** which is not reasonably required for a prudent and sound Demand Assessment.

- (c) The Demand Assessment report:
 - (i) must not exceed the quantum of out-loading capacity being sought at the coal terminal (if the Demand Assessment is triggered by the operator of an existing or proposed coal terminal);
 - (ii) may investigate different capacity permutations in branch lines to reflect anticipated origin points for the port infrastructure (if relevant);
 - (iii) must not identify individual Access Seekers or Prospective Access Seekers by name or, to the extent practicable, precise origins or destinations for trains utilising the potential Expansion; and
 - (iv) must aggregate capacity information so that capacity use or requirements cannot be associated with a particular Access Seeker, Prospective Access Seeker or Access Holder.

8.2.5 Participation of Customers

- (a) If Aurizon Network proposes to conduct a Pre-feasibility Study, Feasibility Study or Expansion, it must notify any Customer or Access Seeker who could reasonably be expected to be interested in funding the cost of that Pre-feasibility Study, Feasibility Study or Expansion and provide a reasonable period of time by when that party may indicate to Aurizon Network its desire to fund the cost of that Pre-feasibility Study, Feasibility Study or Expansion.
- (b) If a Customer or Access Seeker wishes to fund the cost of:
 - (i) a Pre-feasibility Study, as a Pre-feasibility Funder under **clause 8.4.2**;

(ii) a Feasibility Study, as a Feasibility Funder under **clause 8.4.3**; or

(iii) an Expansion, as a User under **clause 8.8**,

as applicable, then within the time set out in Aurizon Network's notice, it must give a notice to Aurizon Network that it wishes to do so and agrees to be bound by the provisions of this Undertaking in relation to such matters. Nothing in this **clause 8.2.5(b)** obliges a Customer to give a funding notice earlier than the time required under the relevant part of this **Part 8**.

(c) Where Aurizon Network does not receive a notice under **clause 8.2.5(b)** in respect of a proposed Pre-feasibility Study, Feasibility Study or Expansion (as applicable), then Aurizon Network may refuse to negotiate agreements in relation to such matters with that Customer or Access Seeker or to otherwise treat it as a proposed Pre-feasibility Funder or Feasibility Funder.

(d) Where Aurizon Network considers, acting reasonably, that a Customer or Access Seeker has materially failed to comply with any provision of this Undertaking relating to the funding of the cost of a Pre-feasibility Study, Feasibility Study or an Expansion (as applicable), then Aurizon Network may, without prejudice to any other rights it may have, do either or both of the following:

(i) give a written Negotiation Cessation Notice to the Customer or Access Seeker under **clause 4.13(a)**; and

(ii) cease any other relevant negotiations with that Customer or Access Seeker in relation to the funding of the cost of the Pre-feasibility Study, Feasibility Study or an Expansion (as applicable) by giving notice to that Customer,

except that if the Negotiation Cessation Notice is disputed by the Customer or Access Seeker, the notice is not effective, and the parties must continue as if the notice had not been given, until the Dispute is resolved.

8.2.6 Compliance with obligations

Aurizon Network must meet its obligations under this **Part 8** in respect of Concept Studies, Pre-feasibility Studies, Feasibility Studies and Expansions, despite any resource constraints on Aurizon Network.

8.3 Undertaking Concept Studies, Pre-feasibility Studies and Feasibility Studies

8.3.1A Application

For clarity, the provisions of this **clause 8.3** do not apply in the case of Expansions to be undertaken in accordance with **clause 07A-5** to address any Existing Capacity Deficit.

8.3.1 *Concept Studies*

- (a) Aurizon Network must promptly undertake a Concept Study:
- (i) for capacity that is consistent with the capacity identified in the relevant Demand Assessment report finalised under **clause 8.2.4**; or
 - (ii) if requested by any person (in which case, Aurizon Network may require that person to fund the Concept Study),
- unless a sufficient Concept Study for the relevant Expansion is already underway or completed.
- (b) Any person may request Aurizon Network to undertake a Concept Study on its behalf (except to the extent that **clause 8.3.1(a)** permits Aurizon Network to not undertake that study) in which case:
- (i) the costs incurred by Aurizon Network in undertaking that study must not be included as part of the Regulatory Asset Base except to the extent that that Expansion is developed and the costs associated with the Expansion is included as part of the Regulatory Asset Base; and
 - (ii) Aurizon Network must cooperate with that person and provide all reasonable assistance to that party.
- (c) Aurizon Network will include in its Network Development Plan general details of:
- (i) each Concept Study it is undertaking promptly after commencement of work on the Concept Study; and
 - (ii) the project configuration alternatives appropriate for Pre-feasibility Study consideration,
- regardless of whether or not the Concept Study is funded by Aurizon Network or another person.

8.3.2 *Pre-feasibility Study*

Following a Concept Study, Aurizon Network must immediately commence a Pre-feasibility Study for that Expansion, if:

- (a) one (1) or more Potential Pre-feasibility Funders give notice to Aurizon Network that they will:
- (i) fund the Pre-feasibility Study; and
 - (ii) enter into a Studies Funding Agreement for the Expansion and for an amount equal to or greater than the estimate of the cost of that Pre-feasibility Study determined in the Concept Study for that Expansion,

and that the conditions precedent set out in the Studies Funding Agreement referred to in **clause 8.3.2(a)(ii)** are satisfied or waived in accordance with the terms of that agreement;

- (b) subject to **clause 8.4.2(b)**, the Potential Pre-feasibility Funders and Aurizon Network agree that Aurizon Network should fund the Pre-feasibility Study; or
- (c) subject to **clause 8.4.2(b)**, Aurizon Network chooses, at its discretion, to fund the Pre-feasibility Study itself in circumstances where no unconditional Studies Funding Agreement comes into effect as contemplated by **clause 8.3.2(a)**:
 - (i) within forty (40) Business Days after the date of a communication referred to in **clause 8.4.2(d)(ii)**; or
 - (ii) within fifteen (15) Business Days after QCA determination of a Dispute in respect of Aurizon Network's decision under **clause 8.4.2(c)**.

8.3.3 Feasibility Studies

- (a) Following a Pre-feasibility Study, Aurizon Network must immediately commence a Feasibility Study for that Expansion if one or more of the Potential Feasibility Funders give notice to Aurizon Network that they will:
 - (i) fund the Feasibility Study; and
 - (ii) enter into a Studies Funding Agreement for that Expansion, and all of the conditions precedent set out in the Studies Funding Agreement referred to in **clause 8.3.3(a)(ii)** are satisfied or waived in accordance with the terms of that agreement.
- (b) Aurizon Network must (acting reasonably and in good faith) determine the target amount of Capacity for the potential Expansion to be investigated in the proposed Feasibility Study (**Target Capacity**):
 - (i) at any time prior to the Initial Capacity Assessment Report being published by the QCA on its website, by having regard to:
 - (A) the outcomes of the Pre-feasibility Study, including the scope determined for the Feasibility Study;
 - (B) the total indicative demand for Capacity from all the relevant Access Seekers that satisfy the requirements under **clause 8.4.3(a)(ii)**;
 - (C) the potential scope of the proposed Expansion;
 - (D) the capacity of the port or other unloading facility relevant to the use of the proposed Expansion; and
 - (E) any potential staging of Expansions; and
 - (ii) thereafter, by having the Independent Expert undertake a Deliverable Network Capacity Analysis having regard to the factors in **clause 8.3.3(b)(i)** and by Aurizon Network

adopting the result of that Deliverable Network Capacity Analysis as the Target Capacity.

- (c) Aurizon Network will notify all the relevant Access Seekers of:
 - (i) the Target Capacity for the potential Expansion to be investigated in the Feasibility Study, as determined under **clause 8.3.3(b)**;
 - (ii) the total indicative demand for Capacity from all the relevant Access Seekers that satisfy the requirements under **clause 8.4.3(a)(ii)**; and
 - (iii) if the total demand under **clause 8.3.3(c)(ii)** is more than the Target Capacity under **clause 8.3.3(c)(i)**, the reasons why a higher Target Capacity has not been proposed.

8.3.4 General provisions

- (a) Aurizon Network must not make any amendments to the scope (as the scope is defined in the relevant definition in **Part 12**) of:
 - (i) the Concept Study;
 - (ii) the Pre-feasibility Study; or
 - (iii) the Feasibility Study,that are not agreed by all funders of the Concept Study, Pre-feasibility Funders or Feasibility Funders, as applicable.
- (b) Unless otherwise agreed by Aurizon Network and a proposed Pre-feasibility Funder or Feasibility Funder, a Studies Funding Agreement for a Pre-feasibility Study or Feasibility Study (as applicable) must be in the form of the Standard Studies Funding Agreement.
- (c) Aurizon Network and the proposed Pre-feasibility Funders or Feasibility Funders, as applicable, must agree on the completion of schedules in a Studies Funding Agreement in the form of the Standard Studies Funding Agreement within:
 - (i) twenty (20) Business Days of a communication referred to in **clause 8.4.2(d)(ii)** or **8.4.3(d)**, as applicable; or
 - (ii) if a decision communicated in accordance with **clause 8.4.2(d)** or **8.4.3(d)**, as applicable, is referred for dispute resolution, within five (5) Business Days following the QCA's decision.
- (d) The capital expenditure for an Expansion includes the cost of a Pre-feasibility Study or Feasibility Study relating to that Expansion except that any amounts that are not repaid or reimbursed (as applicable):
 - (i) for a Pre-feasibility Study, under **clause 8.4.4(b)(iii)(A)**; and

- (ii) for a Feasibility Study, under **clause 8.4.4(b)(iii)(B)**, will not be treated as capital expenditure and will not be included in the Regulatory Asset Base.
- (e) Without limiting any provision of this Undertaking, Aurizon Network is not obliged to construct, fund or permit an Expansion or to undertake a Feasibility Study, merely because Aurizon Network undertakes or funds any Pre-feasibility Study or Feasibility Study relating to that Expansion.
- (f) Aurizon Network must publish to relevant Access Seekers (and, where applicable, their Customers) general details of each multi-user Pre-feasibility Study and Feasibility Study it is undertaking promptly after commencement of work on the Pre-feasibility Study or Feasibility Study. The publication must not identify individual Access Seekers by name, precise details of origins and destinations (to the extent possible) or any other confidential information.
- (g) The Concept Study, Pre-feasibility Study or Feasibility Study must be provided as a complete and transparent document:
 - (i) to the QCA on an unredacted basis; and
 - (ii) to a party other than the QCA or relevant Access Seeker (or, where applicable its Customer) or in the Network Development Plan (if a Concept Study), including the Independent Expert:
 - (A) to the extent permitted by any confidentiality obligations it may have in relation to the information contained in the Concept Study, Pre-feasibility Study or Feasibility Study (and if those obligations permit disclosure if required by this Undertaking, then Aurizon Network is required to disclose the information contained in the Concept Study, Pre-feasibility Study or Feasibility Study), on an unredacted basis; and
 - (B) if complete disclosure is not permitted by Aurizon Network's confidentiality obligations:
 - (1) Aurizon Network must use all reasonable endeavours to obtain the consent of the relevant Third Party to disclose the information contained in the Concept Study, Pre-Feasibility study or Feasibility Study on an unredacted basis;
 - (2) in respect of the information referred to in **paragraph (i)** or for which consent is obtained under **paragraph (ii)(A)**, on an unredacted basis; and

- (3) in respect of the information that does not satisfy **paragraph (i)** or for which consent is not obtained under **paragraph (ii)(a)**:
 - to the extent possible on an unredacted basis but aggregated so as to avoid disclosing the information that is confidential and unable to be disclosed; and
 - to the extent not possible, on a redacted basis.
- (h) Aurizon Network must use reasonable endeavours to agree to confidentiality obligations that:
 - (i) do not prevent the disclosure of the information contained in a Concept Study, Pre-feasibility Study or Feasibility Study; and
 - (ii) permit disclosure of information required by this Undertaking, but in any event, must not agree to any confidentiality obligations that prevent disclosure to the QCA.

8.4 Funding Concept Studies, Pre-feasibility Studies and Feasibility Studies

8.4.1A Application

For clarity, the provisions of this **clause 8.4** do not apply in the case of Expansions to be undertaken in accordance with **clause 07A.5** to address any Existing Capacity Deficit.

8.4.1 Concept Studies

- (a) Aurizon Network must fund all Concept Studies except:
 - (i) if an Access Seeker (or, as applicable, Customer), at its absolute discretion, agrees to fund the Concept Study; or
 - (ii) **clause 8.3.1(a)(ii)** applies.
- (b) If Aurizon Network does not fund a Concept Study, the funding party must not be provided with any rights that person would not otherwise be entitled to had they not funded the Concept Study. For clarity, this includes providing the funding Access Seeker (or, as applicable, Customer) with priority for the Expansion relevant to that Access Seeker (or, as applicable, Customer).

8.4.2 Pre-feasibility Studies

- (a) Subject to **clause 8.4.2(b)**, if all of the relevant Studies Funding Agreements for a Pre-feasibility Study terminate prior to completion of a Pre-feasibility Study, then Aurizon Network may (in its discretion) elect to continue to undertake and complete the Pre-feasibility Study

at its own cost (in which case Aurizon Network releases the relevant Pre-feasibility Funders from any further liability with respect to that Pre-feasibility Study).

- (b) If Aurizon Network elects to fund the Pre-feasibility Study in accordance with **clause 8.3.2(b)** or **8.3.2(c)**, or elects to continue to undertake and complete a Pre-feasibility Study under **clause 8.4.2(a)**:
 - (i) Aurizon Network must not afford an Access Seeker (or, as applicable, Customer) any rights that Access Seeker (or, as applicable, Customer) would not otherwise be entitled had Aurizon Network not funded the Pre-feasibility Study; and
 - (ii) the costs incurred by Aurizon Network must not be included as part of the Regulatory Asset Base except to the extent that that Expansion is developed and the costs associated with the Expansion is included as part of the Regulatory Asset Base.
- (c) The Access Seekers (or, as applicable, Customers) to be given an opportunity to fund a Pre-feasibility Study under **clause 8.3.2(a)** for an Expansion, as proposed Pre-feasibility Funders, will be:
 - (i) where Aurizon Network knows that a Capacity Shortfall or Expansion Capacity Deficit (as applicable) exists and the proposed Expansion could create Capacity that would reduce or remove the Capacity Shortfall or Expansion Capacity Deficit (as applicable), Conditional Access Seekers who are deemed to have lodged an Access Application under **clause 8.9.3(a)(ii)** or **clause 8.9.4(d)(ii)** to which that Capacity Shortfall or Expansion Capacity Deficit (as applicable) relates (or, as applicable, their Customers); and
 - (ii) each of the Access Seekers (or, as applicable, their Customers) who Aurizon Network considers, acting reasonably, satisfy the following requirements:
 - (A) is participating in a process for the acquisition or development of out-loading capacity (such as an expression of interest process or study funding process in relation to a coal export terminal or a domestic power station or similar out-loading facility) or otherwise has a reasonable likelihood of obtaining out-loading capacity, in either case, in a timeframe and having an out-loading capacity entitlement that are consistent with the Access Seeker's Access Application;
 - (B) where the relevant Access Seeker (or, as applicable, their Customer) is a producer of coal:
 - (1) has at least an Exploration Permit for Coal under the *Mineral Resources Act 1989* (Qld);

- (2) has a credible program for the development of its mine or mine expansion on a basis that is consistent with its Access Application; and
 - (3) is diligently developing its mine or mine expansion in accordance with the development program referred to in **paragraph 8.4.2(c)(ii)(B)(2)**;
 - (C) where the relevant Access Seeker (or, as applicable, their Customer) is a consumer of coal:
 - (1) has or is reasonably likely to obtain the licences, approvals, consents, permits and other permissions (if any) necessary to evaluate the feasibility of the business or activity for which Access Rights are required;
 - (2) has a credible program for the development of any infrastructure or other facilities and has or is likely to secure coal necessary for that business or activity; and
 - (3) is diligently developing any infrastructure or other facilities in accordance with the development program referred to in **clause 8.4.2(c)(ii)(C)(2)**; and
 - (D) where applicable, has either provided a bank guarantee in accordance with the relevant Study Funding Agreement or otherwise has the ability to meet the funding obligation under the terms of the relevant Studies Funding Agreement.
- (d) Following a decision under **clause 8.4.2(c)**, Aurizon Network will advise each Access Seeker (or, as applicable, Customer) who was:
 - (i) not selected to fund the Pre-feasibility Study, of that fact; and
 - (ii) selected to fund the Pre-feasibility Study, of that fact and of the Access Rights for which it has been selected to participate in the funding of the Pre-feasibility Study.

8.4.3 Feasibility Studies

- (a) Subject to **clauses 8.4.3(b)** and **8.4.3(e)**, the Access Seekers (or, as applicable, Customers) to be given an opportunity to fund a Feasibility Study under **clause 8.3.3(a)** for an Expansion, as proposed Feasibility Funders, will be:
 - (i) firstly, Access Seekers that satisfy the requirements of **clause 8.4.2(c)(i)** other than any of them who (or whose Customer) were offered an opportunity to fund the Pre-feasibility Study for the Expansion but did not become a Pre-feasibility Funder for that Pre-feasibility Study; and

- (ii) secondly, subject to **clause 8.3.3(b)**, those Access Seekers (or, as applicable, their Customers) whom Aurizon Network decides (acting reasonably) satisfy all of the requirements of **clause 8.4.2(c)(ii)** and, in addition, either:
 - (A) where the relevant Access Seeker (or, as applicable, their Customer) is a producer of coal:
 - (1) has at least a Mineral Development Licence under the *Mineral Resources Act 1989* (Qld); and
 - (2) has Marketable Coal Reserves (as defined by the JORC Code) equal to at least ten (10) times the annual capacity for which Access is required (as determined by reference to the Access Seeker's access application), following ramp up; or
 - (B) where the relevant Access Seeker (or, as applicable, their Customer) is a consumer of coal:
 - (1) has or will obtain all licences, approvals, consents, permits and other permissions necessary for the business or activity for which Access Rights are required; and
 - (2) has or is reasonably likely to obtain a supplier or suppliers of coal in connection with the business or activity for amounts of coal consistent with the Access Rights requested.
- (b) for the purposes of **clause 8.4.3(a)**:
 - (i) where the Access Seeker has a Customer (the identity and details of which has been notified to Aurizon Network by the Access Seeker):
 - (A) Aurizon Network will notify the Customer that it is identifying Potential Feasibility Funders for the relevant Feasibility Study; and
 - (B) the Customer must notify Aurizon Network within ten (10) Business Days after receiving that notice:
 - (1) that the Customer should be considered for an opportunity to fund the Feasibility Study (rather than the Access Seeker) (**Customer Nomination**); or
 - (2) that the Access Seeker (and, where there are two (2) or more Access Seekers seeking the same access rights, which of the Access Seekers) should be considered for an opportunity to fund the Feasibility Study

(rather than the Customer or any other of those Access Seekers) (**Access Seeker Nomination**);

- (ii) where Aurizon Network is given:
 - (A) a Customer Nomination under **clause 8.4.3(b)(i)(B)(1)**, only the Customer can be eligible for an opportunity to fund the relevant Feasibility Study (and not the Access Seeker(s) for the Customer); or
 - (B) an Access Seeker Nomination under **clause 8.4.3(b)(i)(B)(2)**, only the nominated Access Seeker can be eligible for an opportunity to fund the relevant Feasibility Study (and not the Customer or any other relevant Access Seeker for the Customer); and
- (iii) where the Customer does not give Aurizon Network a Customer Nomination or an Access Seeker Nomination under **clause 8.4.3(b)(i)(B)**, neither that Customer nor that Customer's Access Seeker(s) can be eligible for an opportunity to fund the relevant Feasibility Study.
- (c) If the Target Capacity to be created by the proposed Expansion as determined under **clause 8.3.3(b)** by Aurizon Network is expected to be insufficient Capacity for all the relevant Access Seekers that satisfy the requirements under **clause 8.4.3(a)(ii)**, then Aurizon Network will make a decision to give priority to Access Seekers or Customers having regard to the following criteria (in order of priority):
 - (i) those Access Seekers who meet the requirements set out in **clause 8.4.3(a)(ii)** to a greater extent than other Access Seekers; and
 - (ii) the Access Seekers who funded the Pre-feasibility Study.

For clarity, the assessment under this **clause 8.4.3(c)** will be undertaken to ensure that the aggregate of requested capacity of the proposed Feasibility Funders is not more than (and wherever possible equals) the Target Capacity for which the Feasibility Study is being conducted.
- (d) Following a decision under **clause 8.4.3(a)**, Aurizon Network will notify:
 - (i) each Access Seeker (or, as applicable, Customer) who was not selected to fund the Feasibility Study, of that fact; and
 - (ii) each Access Seeker (or, as applicable, Customer) who was selected to fund the Feasibility Study of:
 - (A) that fact;

- (B) the Access Rights for which the Access Seeker has been selected to participate in the funding of the Feasibility Study; and
 - (C) the date by which Aurizon Network anticipates that an Access Agreement or a User Funding Agreement, as applicable, in respect of the funding and construction of the Expansion the subject of the Feasibility Study would become unconditional.
- (e) Aurizon Network will provide details to each relevant Access Seeker (or, as applicable, Customer) of Aurizon Network's assessment of that Access Seeker's case against the requirements and criteria in **clause 8.4.3(a)(ii)**.
- (f) Aurizon Network must not give effect to a decision under **clause 8.4.3(c)** until:
 - (i) if Aurizon Network's decision has not been referred to the QCA for resolution as a Dispute, twenty (20) Business Days after receipt by the Access Seekers of the notice under **clause 8.3.3(c)**; or
 - (ii) if Aurizon Network's decision has been referred to the QCA for resolution of a Dispute, the QCA has made its determination.
- (g) Feasibility Studies must be funded by Access Seekers and/or, as applicable, Customers and must not be funded by:
 - (i) Aurizon Network, except where **clause 8.4.4(b)(i)** applies; or
 - (ii) a Railway Operator acting as an Access Seeker, other than where a specifically identified Customer has made an Access Seeker Nomination under **clause 8.4.3(b)(i)(B)(2)** in favour of that Railway Operator.
- (h) Where this **Part 8** provides that a Railway Operator (acting as an Access Seeker) cannot act other than on behalf of an identified Customer:
 - (i) that Railway Operator must notify Aurizon Network of the identity and details of the Customer on whose behalf it is purporting to act; and
 - (ii) Aurizon Network must make reasonable inquiries to verify the identity of that Customer and confirm that the Customer agrees to the Railway Operator acting on its behalf.

8.4.4 *General provisions*

- (a) If a Pre-feasibility Study or Feasibility Study for an Expansion is funded by more than one Pre-feasibility Funder or Feasibility Funder under Studies Funding Agreements, then Aurizon Network must ensure that each Pre-feasibility Funder and Feasibility Funder either:

- (i) provides a bank guarantee for the amount required in the relevant Study Funding Agreement as a condition precedent to that relevant Study Funding Agreement becoming unconditional; or
 - (ii) has the ability to meet its financial obligations under the relevant Study Funding Agreement. For clarity, Aurizon Network may require a bank guarantee for the amount required in the relevant Study Funding Agreement as a condition precedent to that relevant Study Funding Agreement becoming unconditional, despite the Pre-feasibility Funder or Feasibility Funder having the ability to meet its financial obligations under the relevant Study Funding Agreement.
- (b) If a Pre-feasibility Study or Feasibility Study for an Expansion is funded under one or more Studies Funding Agreements, then:
- (i) as a result of the application of **clause 8.4.4(a)**, Aurizon Network must fund any shortfall in the Pre-feasibility Study or Feasibility Study arising as a result of the default of a Pre-feasibility Funder or Feasibility Funder under its Study Funding Agreement if there is more than one Study Funding Agreement for the Pre-feasibility Study or Feasibility Study;
 - (ii) the relevant Feasibility Funders and Expansion Funders (if any) must include in the funding amounts under their Study Funding Agreement or User Funding Agreement, as applicable, amounts that in aggregate equal the amount to be repaid or reimbursed by Aurizon Network:
 - (A) under a Study Funding Agreement for a Feasibility Study, the funding provided by:
 - (1) Aurizon Network in accordance with **clause 8.4.4(b)(i)**; and
 - (2) the pre-feasibility funder under each study funding agreement,
 for the relevant Pre-Feasibility Study; and
 - (B) under a User Funding Agreement or Access Conditions, the funding provided by:
 - (1) Aurizon Network in accordance with **clause 8.4.4(b)(i)**; and
 - (2) the Feasibility Funder under each Study Funding Agreement,
 for the relevant Feasibility Study; and
 - (iii) Aurizon Network must repay or reimburse itself the funding it provided under **clause 8.4.4(b)(i)** or the Pre-feasibility

Funder or Feasibility Funder, as applicable, the funding provided under its Study Funding Agreement when:

- (A) in respect of funding for a Pre-feasibility Study, the Study Funding Agreement for the Feasibility Study become unconditional; and
- (B) in respect of funding for a Feasibility Study:
 - (1) the agreements with Access Seekers (or their Customers) for the funding and construction of that Expansion or the Access Agreement for utilisation of that Expansion have been executed and have become unconditional (save for any condition regarding construction of the Expansion); and
 - (2) a Feasibility Funder is a party to those agreements and will use Access Rights granted as a result of the Capacity to be created by that Expansion.
- (c) If a Pre-feasibility Study or Feasibility Study is funded under one or more Studies Funding Agreements, then Aurizon Network must perform a reconciliation of funding amounts against amounts that Aurizon Network has incurred in performing the Pre-feasibility Study or Feasibility Study, when:
 - (i) a Study Funding Agreement for a Pre-feasibility Study or Feasibility Study is terminated; or
 - (ii) when the report in respect of the Pre-feasibility study or Feasibility Study is completed.
- (d) If the reconciliation under **clause 8.4.4(c)**:
 - (i) shows Aurizon Network has incurred amounts greater than amounts funded, then Aurizon Network must be reimbursed by the Pre-feasibility Funders or Feasibility Funders, as applicable, for that amount; or
 - (ii) shows the Pre-feasibility Funders or Feasibility Funders, as applicable, have funded amounts greater than Aurizon Network has incurred, then Aurizon Network must reimburse that amount to the Pre-feasibility Funders or Feasibility Funders, as applicable.

8.5 Provisional Capacity Allocation

- (a) Where the scope of a Feasibility Study and the schedules of the Studies Funding Agreement for that study have been:
 - (i) agreed by Aurizon Network with all of the proposed Feasibility Funders of the study; or
 - (ii) the subject of a QCA determination,

Aurizon Network will, within five (5) Business Days of that agreement being reached or publication to Aurizon Network of the determination, as applicable, send to each of the Feasibility Funders an executable copy of the Studies Funding Agreement with completed Schedules reflecting the agreement reached or the QCA's determination, as applicable.

- (b) Within twenty (20) Business Days after a Studies Funding Agreement for a Feasibility Study becoming unconditional, Aurizon Network will:
 - (i) issue an IAP (or if one has previously been provided, a revised IAP) to the relevant Access Seeker who is, or whose Customer is, funding the Feasibility Study and to the Independent Expert; and
 - (ii) subject to **clauses 8.5(c) and 8.5(d)**, grant that Access Seeker a provisional allocation of the capacity detailed in the Train Service description included in the Studies Funding Agreement (Provisional Capacity Allocation).
- (c) If an Access Seeker intends to progress its Access Application under the negotiation process set out in this Undertaking on the basis of the arrangements outlined in an IAP or revised IAP issued under **clause 8.5(b)(i)**, that Access Seeker must notify Aurizon Network of that intention within twenty (20) Business Days after Aurizon Network gives a relevant notice under **clause 8.7.1(b)**.
- (d) Subject to **clause 8.5(e)**, all or part of a Provisional Capacity Allocation may be withdrawn by Aurizon Network acting reasonably and in good faith, where:
 - (i) the relevant Access Seeker's circumstances change in a substantial way so that the Access Seeker ceases to satisfy all of the requirements in **clause 8.4.3(a)(ii)**;
 - (ii) (other than due to any default or negligent act or omission of Aurizon Network) the relevant mine or out-loading facility (including an expansion of a mine or out-loading facility) will be delayed by twelve (12) Months or more as compared to the timeframe that was proposed when Aurizon Network made the original assessment;
 - (iii) Aurizon Network exercises a right to lawfully terminate the Feasibility Funder's Studies Funding Agreement; or
 - (iv) Aurizon Network and the relevant Access Seeker (or, as applicable, its Customer) do not execute an Access Agreement or an agreement in relation to the funding and/or construction of the Expansion within one hundred and twenty (120) Business Days (or such longer period as agreed by Aurizon Network acting reasonably and in good faith) after the Independent Expert certifies in accordance with **clause 8.9.1(b)** that the Expansion will deliver sufficient Available

Capacity to provide the Access Rights provided in the Access Application; or

- (v) the Independent Expert assessment under **clause 8.9.2(a)(ii)** indicates that there is an Expansion Capacity Deficit.

For clarity, where a Provisional Capacity Allocation is withdrawn under this **clause 8.5(d)**, Aurizon Network must seek to reallocate that Provisional Capacity Allocation in accordance with **clause 8.5(g)**.

- (e) If Aurizon Network intends exercising its rights under **clause 8.5(d)** to withdraw all or a part of a Provisional Capacity Allocation, it must:
 - (i) give the relevant Feasibility Funder notice and a reasonable opportunity (for a period of at least twenty (20) Business Days) to explain why Aurizon Network should not exercise its rights in the way proposed; and
 - (ii) permit the Feasibility Funder to assign its Study Funding Agreement to a replacement Access Seeker in accordance with the terms of the Study Funding Agreement.
- (f) If having considered any explanation provided by the Access Seeker Aurizon Network (acting reasonably) withdraws all or part of the Provisional Capacity Allocation, it must give the relevant Access Seeker notice, including reasons for its decision. That decision takes effect on the later of:
 - (i) ten (10) Business Days after the date the Access Seeker receives that notice; and
 - (ii) the date of determination of a dispute if the Access Seeker disputes Aurizon Network's decision.
- (g) Subject to the terms of the relevant Studies Funding Agreements, where a Provisional Capacity Allocation is withdrawn under **clause 8.5(d)**, Aurizon Network must to the extent feasible (and provided that other Access Seekers will not be materially delayed) seek a replacement Access Seeker (or, as applicable, Customer) (**Replacement**) for all or some of that Capacity who:
 - (i) will be selected using the criteria set out in **clause 8.4.3(a)**; and
 - (ii) is willing to enter into a Studies Funding Agreement as a Feasibility Funder for the relevant Feasibility Study on the same terms and conditions as the Studies Funding Agreement between Aurizon Network and the Feasibility Funder being replaced,

subject to that Replacement and the other relevant Feasibility Funders agreeing with Aurizon Network any relevant amendments

relating to scope, timing and cost of the Feasibility Study in respect of the Studies Funding Agreement for that Feasibility Study.

- (h) For clarity, if a proposed replacement Feasibility Funder enters into a Studies Funding Agreement in respect of the relevant Feasibility Study, then **clauses 8.5(b) to 8.5(d)** apply to that replacement Feasibility Funder.
- (i) It will be a term of the Studies Funding Agreement entered into by a replacement Feasibility Funder that it must pay all costs incurred by the exiting Access Seeker to the date of the withdrawal of the Provisional Capacity Allocation under **clause 8.5(d)** to Aurizon Network who must refund those costs to the exiting Access Seeker.
- (j) A Provisional Capacity Allocation will automatically cease to apply upon the Access Seeker to which that Provisional Access Allocation applies signing an Access Agreement, Access Conditions or User Funding Agreement relating to corresponding Access Rights.

8.6 Step-in where Aurizon Network fails to enter into Studies Funding Agreement or delay doing so

- (a) If:
 - (i) either:
 - (A) Aurizon Network fails to enter into a Studies Funding Agreement in accordance with this Undertaking or unreasonably delays doing so;
 - (B) Aurizon Network fails to commence a Concept Study, Pre-feasibility Study or Feasibility Study within twenty (20) Business Days after the Studies Funding Agreement for the relevant study becoming unconditional; or
 - (C) there is a reasonable expectation that the relevant Pre-feasibility Study or Feasibility Study (as applicable) cannot be completed by Aurizon Network prior to the date (**Completion Date**) that is sixty (60) Business Days after the target date specified (including as amended, extended or otherwise varied from time to time) in accordance with the Studies Funding Agreement (**Performance Delay**);
 - (ii) a relevant affected Access Seeker (or, as applicable, Customer) who is a proposed party or party to the relevant Studies Funding Agreement has given notice to Aurizon Network's Executive Officer:
 - (A) identifying the alleged failure, unreasonable delay or Performance Delay; and

- (B) in the case of the circumstance referred to in **clause 8.6(a)(i)(A)**, (under the hand of a person with authority to bind the Access Seeker and who warrants that he or she has that authority when giving the notice), confirming that the Access Seeker is ready, willing and able to execute a Studies Funding Agreement as previously agreed or as determined by a final, binding determination in accordance with the provisions of this Undertaking;
- (iii) where the failure or unreasonable delay is that referred to in **clause 8.6(a)(i)(A)**, Aurizon Network fails to enter into the Studies Funding Agreement within ten (10) Business Days after receiving the relevant notice under **clause 8.6(a)(ii)**; and
- (iv) where there is a failure referred to in **clause 8.6(a)(i)(B)** or an alleged Performance Delay referred to in **clause 8.6(a)(i)(C)**, Aurizon Network:
 - (A) fails to prepare and provide to the relevant affected Access Seeker (or, as applicable, Customer), within ten (10) Business Days after receiving the relevant notice under **clause 8.6(a)(ii)**, a response confirming that Aurizon Network will commence the study or complete the study by the Completion Date (and supported by reasonable particulars demonstrating how completion will be achieved); or
 - (B) after preparing and providing such a response to the relevant affected Access Seeker (or, as applicable, Customer), materially fails, due to its own acts or omissions, to comply with any aspect of that response,

then a relevant affected Access Seeker (or, as applicable, Customer) may refer the matter to the QCA for resolution as a Dispute under **Part 11**.

- (b) If the QCA determines that Aurizon Network:
 - (i) is obliged to enter into a Studies Funding Agreement and, subject to **clause 8.6(a)(iii)**, has failed unreasonably to do so or unreasonably delayed doing so; or
 - (ii) has failed to commence a study under **clause 8.6(a)(i)(B)** and either:
 - (A) failed to provide a response within the time specified in **clause 8.6(a)(iv)(A)**; or

- (B) has failed to comply with the steps detailed in the response provided under **clause 8.6(a)(iv)(A)**; or
- (iii) has been the cause of a Performance Delay (as described in **clause 8.6(a)(i)(C)**) and either:
 - (A) failed to provide a response within the time specified in **clause 8.6(a)(iv)(A)**; or
 - (B) has failed to comply with the steps detailed in the response provided under **clause 8.6(a)(iv)(A)**,

the QCA may (with the approval of all relevant Access Seekers and Customers) determine that the relevant study be undertaken by an appropriately qualified and experienced nominee of all relevant Customers.

- (c) If the QCA determines that the relevant study is to be undertaken by the nominee of all relevant Customers:
 - (i) Aurizon Network must comply with that determination;
 - (ii) the nominee must:
 - (A) comply with all confidentiality obligations that Aurizon Network is required to comply with in respect of the information coming to their knowledge by reason of their appointment and performance of the study; and
 - (B) give Aurizon Network an undertaking to keep confidential and not use for another purpose all information and other matters coming to their knowledge by reason of their appointment and performance of the study which if disclosed or used for another purpose could constitute a breach of Aurizon Network's obligations under **Part 3**;
 - (iii) if the nominee provides Aurizon Network the undertaking referred to in **clause 8.6(c)(ii)**, then despite Aurizon Network's obligations under Part 3 Aurizon Network must provide the nominee with all reasonable assistance, including information, which is reasonably required by the nominee to undertake the applicable study; and
 - (iv) Aurizon Network must use the relevant study output for the purposes for which it was provided.
- (d) If a study is undertaken by a nominee of all relevant Customers as contemplated by **clause 8.6(c)** Aurizon Network must implement the output of the study for completion of the applicable Feasibility Study, User Funding Agreement or Access Agreement, except to the extent that Aurizon Network successfully seeks a review of the scope (which may include the standard of work) of the Expansion referred to in the study by means of a QCA determination.

- (e) Aurizon Network:
 - (i) may refer the matter to the QCA under **Part 11** within twenty (20) Business Days following publication to Aurizon Network of the study by the nominee;
 - (ii) must provide notice of its dispute to the relevant Access Seekers, each of whom may make submissions to the QCA in respect of the dispute; and
 - (iii) must provide written submissions to the QCA, with copies to each of the relevant Access Seekers, detailing why, in Aurizon Network's view, the scope (which may include the standard of work) decided by the nominee is not appropriate and how it should be amended.

8.7 Funding an Expansion

8.7.1A Application

For clarity, the provisions of this **clause 8.7** do not apply in the case of Expansions to be undertaken to address any Existing Capacity Deficit.

8.7.1 General

- (a) Aurizon Network will within 20 Business Days after completion of a Pre-Feasibility Study report provide written advice to:
 - (i) where the Pre-Feasibility Study was funded by the Pre-Feasibility Funders, those Pre-Feasibility Funders; or
 - (ii) where there were no Pre-Feasibility Funders, the Access Seekers or Customers requiring the Expansion in order to obtain the Access Rights,
 confirming:
 - (iii) whether Aurizon Network is:
 - (A) willing to fund the Expansion at the Approved WACC; or
 - (B) not willing to fund the Expansion; and
 - (iv) if Aurizon Network is willing to fund the Expansion subject to Access Conditions, the Access Conditions on which Aurizon Network is willing to fund the Expansion,

(Initial Funding Notice).
- (b) If Aurizon Network confirms, in accordance **clause 8.7.1(a)(iii)(A)** that it is willing to fund the Expansion at the Approved WACC:
 - (i) Aurizon Network will promptly commence a Feasibility Study for the Expansion in accordance with **clause 8.3.3**;

- (ii) Aurizon Network must give the parties referred to in **clause 8.7.1(a)** a notice of its decision to fund the Expansion at the Approved WACC; and
 - (iii) the Expansion will not be a User Funded Expansion unless and to the extent that Aurizon Network fails to fund the Expansion.
- (c) If Aurizon Network has not given an Initial Funding Notice under **clause 8.7.1(a)** then (for the purpose of Access Seekers commencing the processes under **clause 8.8.1(a)**) Aurizon Network is deemed to have given an Initial Funding Notice under **clause 8.7.1(a)(iii)(B)** stating that it is not willing to fund the Expansion.
- (d) If Aurizon Network:
- (i) provides, or is deemed to have provided, notice under **clause 8.7.1(a)(iii)(B)** that it is not willing to fund an Expansion; or
 - (ii) provides notice under **clause 8.7.1(a)(iv)**, that it is willing to fund the Expansion subject to Access Conditions,
- then:
- (iii) an Access Seeker may (itself or through a third party) subject to this **clause 8.7** and **clause 8.8**, fund its relevant portion of the cost of an Expansion that is necessary to create additional Capacity so that the Access Rights requested by the Access Seeker may be granted to the Access Seeker; and
 - (iv) Aurizon Network must agree to the Access Seeker funding (itself or through a third party) its portion of the cost.
- (e) Where an Access Seeker proposes to fund its relevant portion of the cost of an Expansion (itself or through a third party), as contemplated by **clause 8.7.1(d)(iii)**, it must:
- (i) advise Aurizon Network accordingly;
 - (ii) if:
 - (A) the Access Seeker adopts a process for the purpose of obtaining funding from third party potential funders for the relevant portion of the Expansion, provide Aurizon Network with a reasonable opportunity to participate in the process (**Competitive Funding Process**); or
 - (B) the Access Seeker proposes to fund (either itself or through a third party) the relevant portion of that Expansion without adopting a Competitive Funding Process, give Aurizon Network a reasonable

opportunity to propose its own funding terms for the relevant portion of that Expansion; and

- (iii) consider in good faith any proposal submitted by Aurizon Network in response to the opportunity provided by the Access Seeker pursuant to **clause 8.7.1(e)(ii)(A)** or **clause 8.7.1(e)(ii)(B)** provided however that Aurizon Network agrees that this obligation does not in any way fetter the Access Seeker's discretion with respect funding the cost of an Expansion.
- (f) Within 20 Business Days after receipt of the notice referred to in **clause 8.7.1(e)(i)**, Aurizon Network must notify the Access Seeker if Aurizon Network does not wish to participate in any Competitive Funding Process or propose its own funding terms for the relevant portion of the cost of the Expansion. If Aurizon Network does not give the Access Seeker a notice under this **clause 8.7.1(f)** within the 20 Business Day timeframe then it is deemed to have notified the Access Seeker under this **clause 8.7.1(f)** that it does not wish to participate in any Competitive Funding Process and does not wish to propose its own funding terms for the relevant portion of the cost of the Expansion.
- (g) Where Aurizon Network:
 - (i) submits a funding proposal as part of its participation in a Competitive Funding Process; or
 - (ii) otherwise proposes its own funding terms for the relevant portion of the cost of the Expansion,nothing obliges the Access Seeker to accept Aurizon Network's funding proposal or proposed funding terms even if the funding proposal or proposed funding terms is to fund the relevant portion of the Expansion at the Approved WACC.
- (h) Where the Access Seeker forms the view, acting reasonably, that Aurizon Network is not genuinely participating in the Competitive Funding Process, then:
 - (i) the Access Seeker may determine that Aurizon Network should no longer participate in the Competitive Funding Process and may advise Aurizon Network and other participants in the Competitive Funding Process accordingly; and
 - (ii) Aurizon Network must comply with the Access Seeker's determination.
- (i) Where Aurizon Network has provided an Initial Funding Notice under **clause 8.7.1(a)(iv)** and the relevant Access Seeker is willing to negotiate, then **clause 6.13** will apply to the terms on which Aurizon Network will fund the Expansion.

- (j) Where Aurizon Network provides, or is deemed to have provided, notice under **clause 8.7.1(a)(iii)(B)** that it is not willing to fund an Expansion, an Access Seeker may in accordance with **clause 8.8.1** require Aurizon Network to negotiate a User Funding Agreement for the Expansion in parallel to any other negotiations in relation to Access with respect the proposed Expansion.
- (k) Where Aurizon Network is obliged under this Undertaking to fund an Expansion, Aurizon Network must negotiate an Access Agreement in accordance with this Undertaking with those Access Seekers that will utilise the Expansion.
- (l) It is acknowledged that if an Expansion is funded partly by Expansion Funders and partly by Aurizon Network, the terms of the User Funding Agreement to be entered into by the Expansion Funders may need include terms to ensure Aurizon Network is in no better or worse taxation or accounting position than if the Expansion Funders funded the entire Expansion.
- (m) Where Aurizon Network is:
 - (i) granting a Provisional Capacity Allocation under **clause 8.5(b)**; or
 - (ii) negotiating or entering into an Access Agreement,
 Aurizon Network must not have regard to whether any relevant Expansion is or may be a User Funded Expansion or is or may be funded by Aurizon Network.
- (n) Aurizon Network must negotiate non pricing terms and conditions with Access Seekers in good faith.

8.7.2 Inclusion of Expansion cost in Regulatory Asset Base

- (a) The Regulatory Asset Base may include User Funded Expansions (subject to the QCA's approval), notwithstanding that the cost of such Expansions are not paid for by Aurizon Network.
- (b) If the scope of works (including the standard of work) and an estimated cost of an Expansion is:
 - (i) agreed through a Feasibility Study;
 - (ii) determined by the QCA as contemplated by this **Part 8**; or
 - (iii) determined by a nominee under **clause 8.6**,
 Aurizon Network must promptly apply to the QCA following agreement or determination of scope for pre-approval in accordance with the process in **clause 2 of Schedule E**.
- (c) Capital expenditure for the Expansion must only be included in the Regulatory Asset Base in accordance with **Schedule E**.

- (d) If the capital expenditure for the Expansion is not approved for inclusion into the Regulatory Asset Base by the QCA, as contemplated by **Schedule E**, Aurizon Network is not obliged to:
 - (i) fund the cost of that Expansion; nor
 - (ii) construct that Expansion without User Funding.
- (e) If the Expansion is a User Funded Expansion:
 - (i) as soon as is reasonably practicable on completion of the Expansion, Aurizon Network must apply to the QCA to have all of the costs of a User Funded Expansion included in the Regulatory Asset Base. The application must identify that it is made at the request of the Expansion Funders; and
 - (ii) the Expansion Funders may each choose to make their own independent submissions to the QCA in relation to any application made under **Schedule E** or **clause 8.7.2(e)(i)**.

8.8 User Funded Expansions

8.8.1 *Process where Users intend to fund an Expansion*

- (a) If an Access Seeker (or, in relation to an Expansion needed to address an Existing Capacity Deficit, an Access Seeker or Access Holder) intends to fund its relevant portion of the cost of an Expansion under **clause 8.7.1**:
 - (i) each proposed Expansion Funder must give notice to Aurizon Network of its bona fide intention to negotiate a User Funding Agreement for its relevant portion of the cost of the Expansion;
 - (ii) after receiving such notice, Aurizon Network and the proposed Expansion Funders will negotiate acting reasonably and in good faith a User Funding Agreement;
 - (iii) Aurizon Network must provide the proposed Expansion Funders with relevant scope and cost information provided however that the Expansion Funders sign a confidentiality agreement with respect to any commercially sensitive scope and cost information on such terms as Aurizon Network, acting reasonably, may require; and
 - (iv) upon the User Funding Agreement being agreed by Aurizon Network and the Expansion Funders, or its terms being determined through dispute resolution, in accordance with this Undertaking:
 - (A) Aurizon Network will issue the proposed User Funding Agreement to the proposed Expansion Funders and other relevant parties (for example, the State, if applicable), as applicable; and

- (B) Aurizon Network will execute the User Funding Agreement in the manner and sequence required by the User Funding Agreement.
- (b) Aurizon Network must use reasonable endeavours to engage with the State so as to facilitate the State's entry into a User Funding Agreement for each user funding transaction.

8.8.2 *Inconsistency with a User Funding Agreement*

To the extent of any inconsistency, but except for **clauses 8.9.3, 8.9.4 and 8.9.5**, the terms of an executed User Funding Agreement prevail over the terms of this Undertaking as between Aurizon Network and the Expansion Funders (and their Customers, if relevant).

8.9 Contracting for Capacity

8.9.1 *Access Agreements conditional on an Expansion*

- (a) Prior to the Initial Capacity Assessment Report being published by the QCA on its website as contemplated by **clause 7A.4.1(h)**, if Access Rights sought by an Access Seeker require an Expansion, then Aurizon Network must only enter into an Access Agreement with that Access Seeker (other than with a Renewing Access Seeker for a Renewal of an existing Access Agreement in accordance with **clause 7.3**) if:
 - (i) that Access Agreement is subject to a condition precedent that requires the relevant Expansion to have been completed and commissioned;
 - (ii) that Access Agreement includes terms and conditions so that the Access Rights relevant to the Expansion are limited to the available Capacity created by the Expansion; and
 - (iii) either:
 - (A) the Access Seeker and Aurizon Network have agreed the scope of work for the Expansion; or
 - (B) the scope of work for the Expansion has been determined through resolution of a dispute in accordance with **clause 11.1**.
- (b) From the date that the Initial Capacity Assessment Report is published by the QCA on its website (and thereafter), Aurizon Network must only enter into an Access Agreement (other than with a Renewing Access Seeker for a Renewal of an existing Access Agreement in accordance with **clause 7.3**):
 - (i) if the Independent Expert has certified that there is sufficient Available Capacity in that Coal System to grant the Access Rights the subject of the relevant Access Application; or

- (ii) if the Access Rights sought by an Access Seeker require an Expansion:
 - (A) that Access Agreement includes terms and conditions so that the Access Rights are limited to the Capacity created by the Expansion (as determined by the Independent Expert); and
 - (B) either:
 - (1) the Access Seeker and Aurizon Network have agreed the scope of work for the Expansion; or
 - (2) the scope of work for the Expansion has been determined through resolution of a dispute in accordance with **clause 11.1**.

8.9.2 *Capacity analysis*

- (a) If Aurizon Network grants Access Rights pursuant to **clause 8.9.1** (Conditional Access Rights) to Access Seekers (Conditional Access Holders) that are conditional on an Expansion being completed and commissioned, then:
 - (i) prior to the Initial Capacity Assessment Report being published by the QCA on its website as contemplated by **clause 7A.4.1(h)**, Aurizon Network will, no more than six (6) Months following commissioning of the Expansion, undertake an assessment of the Capacity Change. Aurizon Network must notify all of the relevant Conditional Access Holders and the QCA of the conclusions of that assessment and the basis for those conclusions; and
 - (ii) thereafter, within six (6) months of the commissioning of any Expansion, the Independent Expert must undertake an assessment:
 - (A) as to whether the completed Expansion is in all material respects the same as the Expansion that was agreed or determined to be required in accordance with **clause 07A.5** or undertaken pursuant to **Part 8**; and
 - (B) the Capacity Change,
(Expansion Capacity Assessment).
- (b) If Aurizon Network undertakes an Expansion that was agreed or determined in accordance with **clause 07A.5**, within six (6) months of the commissioning of the Expansion, the Independent Expert must undertake an assessment:

- (i) as to whether the completed Expansion is in all material respects the same as the Expansion agreed or determined in accordance with **clause 07A.5**; and
- (ii) of the Capacity Change,
(also an Expansion Capacity Assessment).

8.9.3 Capacity shortfall

- (a) If Aurizon Network's assessment under **clause 8.9.2(a)(i)** indicates that there is a Capacity Shortfall in relation to Conditional Access Holders, then:
 - (i) the Conditional Access Rights of each Conditional Access Holder are proportionally reduced in accordance with this Undertaking or as agreed by all affected Conditional Access Holders; and
 - (ii) subject to **clause 8.9.3(b)**, where those Conditional Access Rights are reduced, each Conditional Access Holder will be deemed to have lodged an Access Application with Aurizon Network for Access Rights equivalent to that reduction if it notifies Aurizon Network within twenty (20) Business Days after the reduction occurs that it wishes to seek Access Rights equal to that reduction.
- (b) For the purpose of a Conditional Access Holder's Access Application under **clause 8.9.3(a)**:
 - (i) the Access Application is taken to be on the same terms as the previous Access Application made by that Conditional Access Holder for those Conditional Access Rights but only to the extent that its Conditional Access Rights have been reduced in accordance with its Access Agreement as a result of the Capacity Shortfall;
 - (ii) Aurizon Network and the Conditional Access Holder are taken to have complied with **clauses 4.2 to 4.4(b)** and **4.8(a) to 4.8(c)**; and
 - (iii) **clause 4.8** applies to the Access Application.
- (c) If there is a Capacity Shortfall, Aurizon Network must meet Affected Access Holders and discuss with them the available options to address that Capacity Shortfall. Aurizon Network must act reasonably in determining available options.
- (d) If Aurizon Network and Affected Access Holders consider that an Expansion is the best option to address any Capacity Shortfall, then:
 - (i) This **Part 8** will apply to that Expansion;
 - (ii) Aurizon Network must give the Affected Access Holders a priority allocation of Capacity in an existing or future process

for the scoping and funding of a related Expansion that can be utilised to address the Capacity Shortfall; and

- (iii) Aurizon Network must act reasonably and negotiate with the Affected Access Holders the terms of a funding arrangement for that Expansion.
- (e) Aurizon Network will not breach this **Part 8** by giving the Affected Access Holders priority allocation of Capacity in accordance with this **clause 8.9.3**.

8.9.4 Expansion Capacity Deficit

- (a) If the Expansion Capacity Assessment indicates that:
 - (i) in the case of an Expansion agreed or determined to be required in accordance with **clause 07A.5**, the Deliverable Network Capacity created by the Expansion is less than the Existing Capacity Deficit required to be addressed by the Expansion; or
 - (ii) in the case of an Expansion undertaken pursuant to **Part 8**, the Deliverable Network Capacity created by the Expansion is less than the Conditional Access Rights which are conditional on the Expansion being completed and commissioned,
(Expansion Capacity Deficit),then the Expansion Capacity Assessment must:
 - (iii) include the quantum of the Expansion Capacity Deficit;
 - (iv) if the Independent Expert identifies a specific cause or causes of the Expansion Capacity Deficit, the cause or causes of the Expansion Capacity Deficit;
 - (v) specify the Access Holders and, if any, Access Seekers affected by the Expansion Capacity Deficit; and
 - (vi) include in reasonable detail, solutions which could efficiently address the Expansion Capacity Deficit.
- (b) The Independent Expert must promptly make the outcomes of its Expansion Capacity Assessment, including its assumptions affecting Deliverable Network Capacity and relied upon for the Expansion Capacity Assessment, available to the QCA.
- (c) The QCA must promptly publish this report on its website.
- (d) If the Independent Expert's assessment under **clause 8.9.2** indicates that there is an Expansion Capacity Deficit in relation to Conditional Access Holders, then:
 - (i) the Conditional Access Rights of each Conditional Access Holder are proportionally reduced in accordance with this

Undertaking or as agreed by all affected Conditional Access Holders; and

- (ii) subject to **clause 8.9.4(e)**, where those Conditional Access Rights are reduced, each Conditional Access Holder will be deemed to have lodged an Access Application with Aurizon Network for Access Rights equivalent to that reduction if it notifies Aurizon Network within twenty (20) Business Days after the reduction occurs that it wishes to seek Access Rights equal to that reduction.
- (e) For the purpose of a Conditional Access Holder's Access Application under **clause 8.9.4(d)**:
- (i) the Access Application is taken to be on the same terms as the previous Access Application made by that Conditional Access Holder for those Conditional Access Rights but only to the extent that its Conditional Access Rights have been reduced in accordance with its Access Agreement as a result of the Expansion Capacity Deficit;
 - (ii) Aurizon Network and the Conditional Access Holder are taken to have complied with **clauses 4.2 to 4.4(b)** and **4.8(a) to 4.4(c)**; and
 - (iii) **clause 4.8** applies to the Access Application.
- (f) If the Independent Expert's assessment under **clause 8.9.2** reveals that there is an Expansion Capacity Deficit, then Aurizon Network must:
- (i) to the extent reasonably possible, identify the cause or causes of the Expansion Capacity Deficit;
 - (ii) consult with Conditional Access Holders to discuss with them the available options to address that Expansion Capacity Deficit. Aurizon Network must act reasonably in identifying and considering available options; and
- within three (3) Months after the Expansion Capacity Assessment has been published by the QCA on its website, submit a detailed report to the QCA showing the outcome of Aurizon Network's analysis and consultation on the Expansion Capacity Deficit, and solutions which it considers would most effectively and efficiently address the Expansion Capacity Deficit (including its proposed implementation plan for those solutions).
- (g) Within 15 days (or such longer period as may be required by the QCA) of receiving a report from Aurizon Network under **clause 8.9.4(f)**, the QCA must make a determination as to whether Aurizon Network is required to undertake a further Expansion to rectify the Expansion Capacity Deficit, provided that the QCA cannot require Aurizon Network to undertake an Expansion if:

- (i) the Independent Expert considers Aurizon Network has complied in all material respects with its obligation to undertake the Expansion in the manner that was agreed or determined to be required in accordance with **clause 07A-5** or undertaken pursuant to **Part 8**; or
 - (ii) the relevant Access Holders and Aurizon Network agree that a further Expansion is not required.
- (h) Subject to **clause 8.9.4(d)**, if the QCA determines that Aurizon should undertake a further Expansion to rectify the Expansion Capacity Deficit, then:
- (A) the Independent Expert appointed under **Part 7A** must review and approve the efficiency and prudence of the proposed further Expansion prior to Aurizon Network incurring any expense in relation to the proposed Expansion, including, if necessary, propose alternative options for an Expansion;
 - (B) **Part 8** will apply to that Expansion; and
 - (C) the Expansion will be funded such that:
 - (1) the inclusion of the further Expansion in the Regulatory Asset Base will be determined in accordance with **Schedule E** to the extent those costs are reasonable and prudent; and
 - (2) Aurizon Network will be responsible for any costs that are not reasonable and prudent (including because such costs would not have been incurred had Aurizon Network constructed the original Expansion in an appropriate and prudent manner).

8.9.5 Reduction of Conditional Access Rights

- (a) If an Access Agreement nominates a Train Service Type as being conditional on completion and commissioning of an Expansion, then:
 - (i) the Access Rights for that Train Service Type under the Access Agreement are Conditional Access Rights for that Train Service Type; and
 - (ii) despite the Train Service Commitment Date specified in the Train Description for the Conditional Access Rights, the Train Service Commitment Date for the Conditional Access Rights will be taken to be the later of:
 - (A) the Train Service Commitment Date for the Conditional Access Rights specified in the Train Description for the Conditional Access Rights; and

- (B) the date upon which all Segments are completed and commissioned.
- (b) Where either **clause 8.9.3(a)(i)** or **clause 8.9.4(d)(i)** applies, the Reduced Conditional Access Rights for a Segment which has a Capacity Shortfall or Expansion Capacity Deficit (as applicable) will be calculated in accordance with the following formula:

$$\text{RCAR} = \text{EAR} \times \frac{\text{CAR}_{(\text{Original})}}{\sum \text{CAR}_{(\text{Original})}}$$

where:

- RCAR = the Reduced Conditional Access Rights for the relevant Segment of the Expansion (expressed as a number of Train Services and rounded down to the nearest even number of whole Train Services)
- EAR = the lesser of:
- (a) the sum of CC and IAC; and
 - (b) $\sum \text{CAR}_{(\text{Original})}$,
(expressed as a number of Train Services)
- CC = the Capacity Change for the relevant Segment of the Expansion (expressed as a number of Train Services)
- IAC = the amount (expressed as a number of Train Services) specified as the “Initial Available Capacity” for the Segment in the Train Description for the Conditional Access Rights in the relevant Access Agreement
- $\text{CAR}_{(\text{Original})}$ = the Conditional Access Rights (expressed as a number of Train Services) in the relevant Access Agreement
- $\sum \text{CAR}_{(\text{Original})}$ = the sum of:
- (i) the Conditional Access Rights (expressed as a number of Train Services) in the relevant Access Agreements; and
 - (ii) for each other Conditional Access Holder for the Segment of the Expansion, the other Conditional Access Holder’s other Conditional Access Rights for the Expansion (expressed as a number of Train Services) in each of their Access Agreements.
- (i) within thirty (30) days after the completion of Aurizon Network’s or the Independent Expert’s assessment under **clause 8.9.2** (as applicable), Aurizon Network must give each Affected Access Holder a notice (**Capacity Assessment Notice**) which specifies:
- (A) the Conditional Access Rights;

- (B) the amount of the Capacity Change for each Segment of the Expansion;
 - (C) whether or not there is a Capacity Shortfall or Expansion Capacity Deficit (as applicable) in respect of any Segment of the Expansion; and
 - (D) if there is a Capacity Shortfall or Expansion Capacity Deficit (as applicable) in respect of any Segment of the Expansion, the Reduced Conditional Access Rights for each such Segment of the Expansion (calculated in accordance with the formula in **clause 8.9.5(b)**), including reasonable details of the calculation of the Reduced Conditional Access Rights for each Segment.
- (c) The Conditional Access Rights in the relevant Access Agreement will be taken to be varied to the lowest of the Reduced Conditional Access Rights for a Segment of the Expansion as:
- (i) specified in the Capacity Assessment Notice; or
 - (ii) as agreed or determined through the dispute resolution process,
- with effect on the later of:
- (iii) twenty (20) Business Days from receipt by the Access Holders of the Capacity Assessment Notice; and
 - (iv) if the Capacity Assessment Notice has been referred to the QCA for resolution of a Dispute, ten (10) Business Days after the Dispute is agreed or determined.

Part 9: Connecting Private Infrastructure

9.1 Connecting Infrastructure

- (a) The Private Infrastructure Owner must give Aurizon Network a written proposal for the proposed connection to the Rail Infrastructure. The written proposal must provide reasonably sufficient details about the proposed connection to allow it to be properly assessed by Aurizon Network against the criteria in **clause 9.1(b)** and for development of a Rail Connection Agreement.
- (b) Within two (2) Months (or such longer period as may be agreed between Aurizon Network and the Private Infrastructure Owner) of receiving the written proposal, Aurizon Network must assess the proposal, acting reasonably and in good faith, and decide whether or not it meets the following criteria:
 - (i) the proposed Connecting Infrastructure is for the purpose of connecting to the Rail Infrastructure in order to allow Trains operating on that Private Infrastructure to enter or exit from the Rail Infrastructure for the purpose of Access;
 - (ii) the proposed Connecting Infrastructure will meet the technical specifications required by Aurizon Network (acting reasonably) for connection to the Rail Infrastructure;
 - (iii) the proposed Connecting Infrastructure is to be constructed to a standard appropriate to the nature of the traffic and the current service standards of the adjoining Rail Infrastructure (including any planned or anticipated Expansion);
 - (iv) the proposed Connecting Infrastructure will not adversely impact on safety; and
 - (v) the proposed Connecting Infrastructure will not, after completion and commissioning of the proposed connection and any related Expansion, reduce Capacity or Supply Chain Capacity.
- (c) Connecting Infrastructure must be owned by Aurizon Network or, where Aurizon Network holds the Rail Infrastructure of which that Connecting Infrastructure will form a part under a lease, must be included under that lease as part of the leased infrastructure.
- (d) Within five (5) Business Days of making its decision under **clause 9.1(b)**, Aurizon Network must notify the Private Infrastructure Owner and the QCA of that decision.
- (e) If Aurizon Network decides the proposal meets the criteria under **clause 9.1(b)**, then within two (2) Months of notifying the Private Infrastructure Owner under **clause 9.1(d)**, Aurizon Network must agree with the Private Infrastructure Owner the timeframes within which Aurizon Network (acting reasonably) will:

- (i) enter into a Rail Connection Agreement with the Private Infrastructure Owner;
- (ii) design and construct any Connecting Infrastructure;
- (iii) commission any Connecting Infrastructure; and
- (iv) complete any other matters Aurizon Network and the Private Infrastructure Owner consider necessary,

(each a **Connection Milestone**) which must be supported by reasons explaining the length of the timeframe selected by Aurizon Network.

- (f) Aurizon Network and the Private Infrastructure Owner may agree to delay setting the Connection Milestones under **clause 9.1(e)** until an Access Agreement which requires the proposed connection to the Rail Infrastructure to be completed has been entered into between the parties.
- (g) Within five (5) Business Days of reaching agreement under **clause 9.1(e)** or agreeing under **clause 9.1(f)** to delay setting the Connection Milestones, Aurizon Network must notify the QCA of either each Connection Milestone (and the reasons supporting each Connection Milestone) or the decision to delay.
- (h) Where Aurizon Network decides that the criteria set out in **clause 9.1(b)** are, or will be, satisfied and that **clause 9.1(c)** will be complied with, it must permit the connection of the Private Infrastructure to the Rail Infrastructure subject to:
 - (i) Aurizon Network and the Private Infrastructure Owner entering into a Rail Connection Agreement in the form of the Standard Rail Connection Agreement (if the Revised Standard Rail Connection Agreement does not apply) or the Revised Standard Rail Connection Agreement (unless the Private Infrastructure Owner agrees with Aurizon Network to vary the terms of the Standard Rail Connection Agreement or Revised Standard Rail Connection Agreement, in which case any amendments proposed to those terms must be negotiated by both Aurizon Network and the Private Infrastructure Owner acting reasonably and in good faith and this will be a negotiation of a Standard Agreement for the purposes of **clause 11.1.1(a)(iii)**);
 - (ii) Aurizon Network gaining access, on terms acceptable to Aurizon Network (acting reasonably and in good faith), to the land necessary to construct, operate, use and maintain the Connecting Infrastructure; and
 - (iii) Aurizon Network and the Private Infrastructure Owner or any other relevant person entering into any other agreements in relation to:

- (A) the design, construction, project management or commissioning of the Connecting Infrastructure; or
 - (B) other works relating to the proposed connection, required under the Rail Connection Agreement or any Law.
- (i) If Aurizon Network decides, acting reasonably and in good faith:
- (i) in accordance with **clause 9.1(b)**, that the criteria set out in **clause 9.1(b)** have not been satisfied; and
 - (ii) to refuse to enter into a Rail Connection Agreement as a result,
- then Aurizon Network must, within five (5) Business Days of making its decision:
- (iii) notify the Private Infrastructure Owner and the QCA of its decision if it has not already done so under **clause 9.1(d)**;
 - (iv) provide reasons for its decision to the Private Infrastructure Owner and the QCA; and
 - (v) specify the amendments it requires to be made to the Private Infrastructure Owner's proposal in order to satisfy the criteria in **clause 9.1(b)** and to enable Aurizon Network to enter into a Rail Connection Agreement.
- (j) If a Private Infrastructure Owner is notified by Aurizon Network under **clause 9.1(i)(iii)**, the Private Infrastructure Owner may re-submit its proposal to Aurizon Network under **clause 9.1(a)**, in which case Aurizon Network must recommence the assessment and decision-making process under **clause 9.1(a)**.
- (k) If connection of the Private Infrastructure to the Rail Infrastructure is permitted under this **clause 9.1**, then unless otherwise agreed with the Private Infrastructure Owner, Aurizon Network:
- (i) must be responsible for designing, constructing, project managing and commissioning the Connecting Infrastructure;
 - (ii) must do so in accordance with the relevant Rail Connection Agreement, Construction Agreement and any other relevant agreement without unreasonable delay;
 - (iii) is entitled to payment for that design, construction, project management and commissioning consisting only of reimbursement of its efficient costs which directly relate to the Connecting Infrastructure, but to the extent only that such costs have not, or will not be, included in the Regulatory Asset Base or recovered by Aurizon Network through other means under this Undertaking; and

- (iv) must not in the technical specifications required by Aurizon Network for connection to the Rail Infrastructure, require higher standards for the design or construction than those required under the relevant legislation and Safety Standards.
- (l) Aurizon Network must pay all reasonable costs (excluding Consequential Loss) incurred by the Private Infrastructure Owner arising directly out of Aurizon Network's unreasonable delay in:
 - (i) entering into:
 - (A) a Rail Connection Agreement;
 - (B) an agreement relating to the design and construction, project management and/or commissioning of any Connecting Infrastructure required under the Rail Connection Agreement or any Law; and
 - (C) an agreement relating to any other works required for the connection or proposed connection under the Rail Connection Agreement or any Law;
 - (ii) designing and constructing any Connecting Infrastructure;
 - (iii) commissioning any Connecting Infrastructure; and
 - (iv) completing any other matters that Aurizon Network and the Private Infrastructure Owner consider necessary.

For the purposes of this **clause 9.1(l)**, "Consequential Loss" means:

- (v) loss of revenue, loss of profits, or loss of production;
- (vi) loss of whatever nature concerning supply of product from a mine to any third party or to make product available to transport;
- (vii) loss of business opportunities;
- (viii) loss of or damage to reputation or good will;
- (ix) wasted overheads;
- (x) loss of or damage to credit rating; and
- (xi) loss or damage that does not naturally, according to the usual course of things, flow from the delay.
- (m) In **clause 9.1(l)**, "unreasonable delay" includes, but is not limited to, Aurizon Network's failure to comply with a Connection Milestone, except to the extent that Aurizon Network's failure to meet the Connection Milestone is a direct result of an event or factor outside Aurizon Network's reasonable control.
- (n) Without limiting **clause 11.1.1**, if the Private Infrastructure Owner and Aurizon Network cannot agree as to:

- (i) the negotiation of an agreement on the Connection Milestones under **clause 9.1(e)**;
 - (ii) whether either party has unreasonably delayed the formation of the agreements mentioned in **clause 9.1(l)(i)**; or
 - (iii) the amount of reasonable costs incurred by the Private Infrastructure Owner, the Access Seeker or Access Holder,
- any party may seek to resolve the Dispute in accordance with **Part 11**.
- (o) Nothing in this **Part 9** requires or obliges either Aurizon Network or the Private Infrastructure Owner to agree that the technical specifications or the completed construction of either the Private Infrastructure or any Connecting Infrastructure is required to the standards or condition for the design or construction of any relevant Rail Infrastructure (including any planned or anticipated Expansion).

9.2 Development of Standard Rail Connection Agreement

- (a) Following consultation with stakeholders, Aurizon Network will submit to the QCA a Proposed Standard Rail Connection Agreement within twelve (12) months after the Approval Date, or such further period as the QCA may, in its absolute discretion, determine.
- (b) The QCA will consider a Proposed Standard Rail Connection Agreement given to it by Aurizon Network under **clause 9.2(a)** and either approve or refuse to approve it within sixty (60) Business Days after it is received by the QCA or such further period as the QCA may determine.
- (c) If the QCA refuses to approve a Proposed Standard Rail Connection Agreement submitted under **clause 9.2(a)**, the QCA will give Aurizon Network a notice in writing:
 - (i) stating the reasons for its refusal; and
 - (ii) requiring Aurizon Network to amend the Proposed Standard Rail Connection Agreement in the way the QCA considers appropriate and to resubmit the amended Standard Rail Connection Agreement to the QCA within sixty (60) Business Days after the giving of that notice or such further period as the QCA may in its absolute discretion determine.
- (d) The QCA may develop a Proposed Standard Rail Connection Agreement that is consistent with the Undertaking, if:
 - (i) Aurizon Network does not submit a Proposed Standard Rail Connection Agreement in accordance with **clause 9.2(a)**;
 - (ii) Aurizon Network does not re-submit the Proposed Standard Rail Connection Agreement in accordance with **clause 9.2(c)**; or

- (iii) the QCA refuses to approve a Proposed Standard Rail Connection Agreement that was re-submitted in accordance with **clause 9.2(c)**.
- (e) The QCA may approve a Proposed Standard Rail Connection Agreement (including a Proposed Standard Rail Connection Agreement developed by the QCA) only if the QCA:
 - (i) is satisfied that, in the case of a resubmitted Proposed Standard Rail Connection Agreement, it is in accordance with the notice given under **clause 9.2(c)**;
 - (ii) is satisfied that the Proposed Standard Rail Connection Agreement is consistent with this Undertaking;
 - (iii) considers it appropriate to do so having regard to the matters listed in section 138(2) of the Act; and
 - (iv) has complied with **clause 9.2(f)**.
- (f) Where Aurizon Network submits a Proposed Standard Rail Connection Agreement under **clause 9.2(a)** or the QCA develops a Proposed Standard Rail Connection Agreement under **clause 9.2(d)**, the QCA will:
 - (i) publish the Proposed Standard Rail Connection Agreement on its website;
 - (ii) invite persons to make submissions on the Proposed Standard Rail Connection Agreement to the QCA within a reasonable period of time specified by the QCA; and
 - (iii) consider any submission it receives within the time specified.
- (g) If the QCA approves a Proposed Standard Rail Connection Agreement:
 - (i) the Revised Standard Rail Connection Agreement will apply from the date of the QCA decision, or such later date that the QCA determines;
 - (ii) the QCA will give Aurizon Network a notice in writing stating the reasons for its decision; and
 - (iii) Aurizon Network must publish the Revised Standard Rail Connection Agreement on its Website.
- (h) An approved Standard Rail Connection Agreement which was submitted in accordance with **clause 9.2(a)** or resubmitted in accordance with **clause 9.2(c)** may only be withdrawn by Aurizon Network if approved by the QCA.
- (i) If the QCA considers it necessary to do so, the QCA may ask Aurizon Network to submit a replacement Standard Rail Connection Agreement within a reasonable period advised by the QCA, in which

case **clauses 9.2(b) to (h)** will apply but with references to **clause 9.2(a)** being read as a reference to this **clause 9.2(i)**.

Part 10: Reporting, compliance and audits

10.1 Overview

This **Part 10** sets out various provisions relating to the reporting requirements for Aurizon Network, in particular:

- (a) **clause 10.3** sets out the reports that Aurizon Network must provide in respect of other matters, particularly the annual financial statements, the Regulatory Asset Base roll-forward report and the findings on the conditions based assessment;
- (b) **clause 10.4** sets out the actions that Aurizon Network must take and the reports that Aurizon Network must provide to assist with showing its compliance with this Undertaking;
- (c) **clause 10.5** sets out the audits that Aurizon Network must undertake and the rules that relate to any audits required by this Undertaking;
- (d) **clause 10.6** sets out general matters relating to provision of information, errors in reports and certification by Aurizon Network's Executive Officer; and
- (e) **clause 10.7** sets out additional network performance information that Aurizon Network must provide.

10.2 General Principles

Unless otherwise required by this Undertaking or agreed between Aurizon Network and the QCA, any report required under this **Part 10** must report separately:

- (a) in respect of each Coal System;
- (b) to the extent applicable, in respect of each Reference Tariff; and
- (c) in respect of the conditions based assessment under **clause 10.4.3**, for each User Funded Expansion.

10.3 Not Used

10.4 Reports

10.4.1 *Annual financial report*

- (a) The financial statements referred to in **clause 3.8** must be certified as being in accordance with this Undertaking by Aurizon Network's Executive Officer.
- (b) Within six (6) Months after the end of each Year in the Term, or such longer time as agreed by the QCA, Aurizon Network must publish on the Website the financial statements relating to the relevant Year which have been prepared and certified under **clause 10.4.1(a)**.
- (c) Within six (6) Months after the later of the Approval Date and the QCA approving the Costing Manual, Aurizon Network must publish on the

Website the financial statements for any Year prior to the Approval Date that have not been published, but is not required to publish for any Year commencing prior to 1 July 2010. Aurizon Network must ensure the financial statements are prepared, audited and certified in accordance with this Undertaking.

10.4.2 Public annual Regulatory Asset Base roll-forward report

- (a) To the extent that the QCA has accepted Aurizon Network's proposed roll-forward of the Regulatory Asset Base under **clause 1.3 of Schedule E**, Aurizon Network must, within four (4) weeks after the QCA's acceptance, publish on the Website a report of changes to the Regulatory Asset Base for the relevant Year containing the information set out in **clause 10.4.2(b)**.
- (b) Aurizon Network will, in the Regulatory Asset Base roll-forward report, include details of:
 - (i) the opening value of the Regulatory Asset Base for the relevant Year;
 - (ii) indexation of the Regulatory Asset Base;
 - (iii) depreciation of the Regulatory Asset Base;
 - (iv) capital expenditure that is included in the Regulatory Asset Base, separately identifying individual projects with a value in excess of \$10 million;
 - (v) disposals and transfers from the Regulatory Asset Base;
 - (vi) the closing value of the Regulatory Asset Base for the relevant Year; and
 - (vii) for comparative purposes, the value of the Capital Indicator for the subject Year.

10.4.3 Conditions Based Assessment

- (a) Aurizon Network must procure a condition based assessment of the Rail Infrastructure no later than three (3) Months prior to the Terminating Date, or such other date as is agreed with the QCA in accordance with this **clause 10.4.3 (Condition Based Assessment)**.
- (b) Aurizon Network will appoint an independent qualified consultant, who has been accepted by the QCA, to conduct the Condition Based Assessment (**Assessor**).
- (c) The Assessor will have a duty of care to the QCA in the conduct of the Condition Based Assessment and, in the event of a conflict between the Assessor's obligations to Aurizon Network and its duty of care to the QCA, the Assessor's duty of care to the QCA will take precedence.
- (d) Prior to commencing the Condition Based Assessment, the Assessor must agree an assessment plan with Aurizon Network, document that

assessment plan and obtain the QCA's approval of that assessment plan.

- (e) The assessment plan will:
 - (i) consist of a proposed work program for conducting the Condition Based Assessment;
 - (ii) provide for the establishment of an assessment liaison group, comprising the Assessor, Aurizon Network and the QCA, during the course of the Condition Based Assessment to provide a forum for the resolution of any issues that arise; and
 - (iii) propose a methodology for assessing Track condition to be agreed between Aurizon Network and the QCA and in the absence of agreement determined by the QCA, but which in any case must be such as to allow for a comparison of results to relevant prior condition based assessments.
- (f) Aurizon Network must provide the Assessor with any relevant information and access to land or sites as reasonably required by the Assessor for the purposes of conducting the Condition Based Assessment.
- (g) To the extent Aurizon Network is requested to provide confidential information to the Assessor, the Assessor will be required to enter into an agreement with Aurizon Network in relation to any information provided by Aurizon Network to the effect that it must keep the information confidential and only use that information for the purpose of conducting the Condition Based Assessment and completing the assessment report.
- (h) The Assessor must provide to Aurizon Network and the QCA a report on the findings of the Condition Based Assessment, including (as far as reasonably practicable) identifying the extent to which the Rail Infrastructure has deteriorated by more than would have been the case had good operating practice and prudent and effective maintenance and asset replacement policies and practices been pursued.
- (i) Aurizon Network must publish the report on the findings of the Condition Based Assessment on the Website.
- (j) Aurizon Network must provide, or make available in accordance with this **clause 10.4.3(j)**, the report on the findings of the Condition Based Assessment as a complete and transparent document:
 - (i) to the QCA on an unredacted basis; and
 - (ii) to stakeholders and when published on its Website:
 - (A) in respect of agreements entered into after the Approval Date of the 2016 Undertaking and to the extent permitted by any confidentiality obligations it

may have in relation to the information contained in the report (and if those obligations permit disclosure if required by this Undertaking then Aurizon Network is required to disclose the information contained in the report), on an unredacted basis; and

- (B) in respect of agreements entered into prior to the Approval Date of the 2016 Undertaking or if complete disclosure is not permitted by Aurizon Network's confidentiality obligations:
- (1) Aurizon Network must use all reasonable endeavours to obtain the consent of the relevant Third Party to disclose the information contained in the report on an unredacted basis;
 - (2) in respect of the information for which consent is obtained under **paragraph (ii)(B)(1)**, on an unredacted basis; and
 - (3) in respect of the information for which consent is not obtained under **paragraph (ii)(B)(1)**:
 - to the extent possible on an unredacted basis but aggregated so as to avoid disclosing the information that is confidential and unable to be disclosed; and
 - to the extent not possible, on a redacted basis.
- (k) Aurizon Network must use reasonable endeavours to agree to confidentiality obligations that:
- (i) do not prevent the disclosure of the information contained in the report on the findings of the Condition Based Assessment; and
 - (ii) permit disclosure of information required by this Undertaking, but
 - (iii) in any event, must not agree to any confidentiality obligations that prevent disclosure to the QCA,
- provided that Aurizon Network will be deemed to have complied with its obligations under this **clause 10.4.3(k)** if it has requested during the negotiation of an Access Agreement that the Access Seeker agrees to confidentiality obligations in accordance with **clause 10.4.3(k)(i)** and **clause 10.4.3(k)(ii)**,

whether or not the access seeker actually agrees to the inclusion of such obligations in the Access Agreement.

- (l) For clarity, the costs and expenses incurred by Aurizon Network in relation to the Condition Based Assessment will be included in the calculation of the AT2-4 components of Reference Tariffs.

10.5 Compliance with this Undertaking

10.5.1 Compliance Officer

- (a) Aurizon Network must appoint a Compliance Officer and advise the QCA as to the identity of the Compliance Officer and of any changes to the identity of the Compliance Officer during the Term.
- (b) The Compliance Officer will be appropriately resourced by Aurizon Network to perform their role, which will include responsibility for:
 - (i) management of the governance framework through systems and practices reasonably required to ensure Aurizon Network complies with its obligations in this Undertaking; and
 - (ii) notifying Aurizon Network's Executive Officer as soon as possible of any material breach of this Undertaking by Aurizon Network and advising of any remedial action proposed or taken by Aurizon Network in respect of the breach.

10.5.2 Annual compliance report

- (a) Within four (4) Months of the end of each Year in the Term, or such longer time as agreed by the QCA, Aurizon Network must publish on the Website an annual compliance report in relation to the subject Year containing the information set out in **clauses 10.5.2(c), (d) and (e)** and which will be accompanied by an audit report prepared in accordance with **clause 10.6.3** in respect of Aurizon Network's compliance with its obligations under this **clause 10.5.2**.
- (b) Aurizon Network must, in conjunction with the publication on the Website of an annual compliance report in accordance with **clause 10.5.2(a)**, provide to the QCA a supplementary report that presents the information included in the public annual compliance report for each of the following classes of Access Holders (on an aggregated basis):
 - (i) Third Party Access Holders; and
 - (ii) Aurizon Party Access Holders.
- (c) Information in relation to Aurizon Network's compliance with this Undertaking over the relevant Year as follows:
 - (i) the number and percentage of Access Applications acknowledged in accordance with this Undertaking and

- within the applicable timeframe nominated in **clauses 4.3(c)** and **4.4(a)**;
- (ii) for those Access Applications received in accordance with this Undertaking and that have not been acknowledged within the applicable timeframe nominated in **clauses 4.3(c)** and **4.4(a)** the average delay (in days) taken to acknowledge the Access Applications;
 - (iii) the number of requests for Capacity Information and percentage acknowledged in accordance with the applicable timeframe nominated in **clause 4.2(c)**;
 - (iv) the number and percentage of Indicative Access Proposals provided in accordance with this Undertaking within the applicable timeframe nominated in **clause 4.6(e)**;
 - (v) the number and percentage of Access Applications received in accordance with this Undertaking for which the time for the provision of an Indicative Access Proposal was extended in accordance with either **clause 4.6(e)** (or **4.6(i)**);
 - (vi) for those Indicative Access Proposals provided in accordance with this Undertaking but that have not been provided within the applicable timeframe nominated in **clause 4.6**, the average delay (in days) taken to provide the Indicative Access Proposals;
 - (vii) the number of instances where a Dispute arose and was referred for resolution under **Part 11**;
 - (viii) the number of instances where a Dispute arose and was referred for resolution under **Part 11** and Aurizon Network was found to have committed a breach of this Undertaking;
 - (ix) the number of instances where Aurizon Network has received a written complaint from a Third Party that it has allegedly breached one or more of its obligations in **Part 3**;
 - (x) the number of instances where Aurizon Network has received a written complaint from a Third Party that it has allegedly breached one or more of its obligations in **Part 3** and Aurizon Network was found to have committed a breach of those ringfencing obligations;
 - (xi) the percentage of Aurizon Network Personnel receiving, in the course of performing their duties, Confidential Information who have completed training in accordance with **clause 3.15(a)**;
 - (xii) the number of instances where an Access Holder has made a written complaint to Aurizon Network about an incorrectly calculated invoice, and where Aurizon Network's

- investigation into the complaint identifies that the invoice was materially incorrectly calculated;
- (xiii) in respect of written complaints that Aurizon Network has made a decision in breach of Aurizon Network's traffic management decision making matrix contained in **clause 9 of Schedule G** (for each of the Railway Operators collectively and Related Operators as Access Holders collectively):
 - (A) the number of complaints received by Aurizon Network;
 - (B) of the complaints received by Aurizon Network, the number which are currently being assessed by Aurizon Network; and
 - (C) of the complaints received by Aurizon Network, the number which, after being assessed by Aurizon Network, were verified as breaches; and
 - (xiv) in respect of written complaints that Aurizon Network has made a decision in breach of Aurizon Network's Contested Train Path decision making process contained in **clause 8 of Schedule G** (for each of the Railway Operators collectively and Related Operators as Access Holders collectively):
 - (A) the number of complaints received by Aurizon Network;
 - (B) of the complaints received by Aurizon Network, the number which are currently being assessed by Aurizon Network; and
 - (C) of the complaints received by Aurizon Network, the number which, after being assessed by Aurizon Network, were verified as breaches.
 - (d) Information in relation to the outcome of Aurizon Network's negotiations with Access Seekers over the relevant Year as follows:
 - (i) the average length of the Negotiation Period (in days), where the Negotiation Period has ceased as the result of the execution of an Access Agreement, or variation to an existing Access Agreement, in respect of the Access sought by the Access Seeker;
 - (ii) the average length of the Negotiation Period (in days), where the Negotiation Period ceased as the result of any reason other than the execution of an Access Agreement, or variation to an existing Access Agreement, in respect of the Access sought by the Access Seeker; and
 - (iii) the number of instances where a Negotiation Period ceased as the result of the execution of an Access Agreement, or

variation to an existing Access Agreement, in respect of the Access sought by the Access Seeker,

with such information to be reported separately for Access Agreements and Train Operations Deed.

- (e) Information in relation to Transfers under **clause 7.4.1** and Part 4 as follows:
- (i) the number of Transfer Notices received in accordance with **clause 7.4**, including identifying:
 - (A) whether the process in **clause 7.4** or **Part 4** applied to the Transfer (disregarding whether the Transfer was effected in accordance with that clause or Part); and
 - (B) the Transfer Period;
 - (ii) the number of Transfers effected in accordance with **clause 7.4** and **Part 4**;
 - (iii) the number of consecutive Transfers for the same Nominated Access Rights that have been effected, including details of whether the Transfer was effected under **clause 7.4** and **Part 4**;
 - (iv) the average length of time (in days) from the date of receipt of a Transfer Notice for a Transfer (completed and submitted in accordance with the requirements of the relevant Access Agreement), to the commencement of the Transferee's new or varied Access Agreement giving effect to the Transfer; and
 - (v) whether the Transferred Access Rights are being granted under:
 - (A) an Access Agreement executed prior to the Approval Date; or
 - (B) an Access Agreement executed on or after the Approval Date that has been negotiated and agreed in accordance with this Undertaking.

10.5.3 Breach reports to the QCA

- (a) Aurizon Network must report to the QCA any breaches of this Undertaking of which Aurizon Network is aware, including advising the QCA of the nature of the breach and the remedial action proposed or taken by Aurizon Network in respect of the breach, at the following times:
- (i) within ten (10) Business Days after the end of each calendar Month, in relation to any breaches of obligations with respect to timeframes that occurred within that calendar Month; and

- (ii) in relation to other breaches, as soon as Aurizon Network becomes aware of the breach.
- (b) If Aurizon Network is obliged to report a breach to the QCA in accordance with this **clause 10.5.3** and that breach directly and adversely affects the interests of an Access Seeker, Access Holder or, if applicable, a Train Operator, then Aurizon Network must also provide the information reported to the QCA in respect of that breach to the relevant Access Seeker, Access Holder or Train Operator.
- (c) Aurizon Network must maintain an Issues Register that includes all information in its possession or knowledge in relation to:
 - (i) any breaches of this Undertaking, of which Aurizon Network is aware, that have occurred on or after the Approval Date;
 - (ii) any alleged breaches of this Undertaking, of which Aurizon Network is aware, that are alleged to have occurred on or after the Approval Date;
 - (iii) any written complaints by an Access Seeker, Access Holder or Train Operator in relation to Aurizon Network's performance of its obligations under this Undertaking on or after the Approval Date of which Aurizon Network is aware; and
 - (iv) the steps taken by Aurizon Network to remediate or otherwise address, and the current status of, all matters recorded on the Issues Register under **clause 10.5.3(c)(i) to 10.5.3(c)(iv)** inclusive.
- (d) The QCA and any Auditor appointed under this **Part 10**, may, at any time, make a written request to Aurizon Network to:
 - (i) inspect the Issues Register; and/or
 - (ii) be provided with an electronic copy of any information recorded on the Issues Register and any documents stored on, or referred to in, the Issues Register,

and Aurizon Network must facilitate such an inspection, and/or provide the relevant information and documents (as applicable), within five (5) Business Days of its receipt of the written request.

10.6 Audit

10.6.1 Report auditing

- (a) An audit of Aurizon Network's compliance with all or a part of its reporting obligations under this **Part 10** must be conducted:
 - (i) annually and as otherwise required in writing by the QCA; and
 - (ii) subject to this **clause 10.6.1**, in accordance with **clause 10.6.4**.

- (b) The Auditor will compile an audit report identifying:
 - (i) whether Aurizon Network has complied in all material respects with its reporting obligations under this **Part 10** and, if not, details as to the relevant non-compliance;
 - (ii) whether any information produced by Aurizon Network under this **Part 10** is inaccurate or misleading in a material respect; and
 - (iii) the process adopted for the conduct of the audit.
- (c) If the QCA requires an audit of Aurizon Network's compliance with all or a part of its obligations under this **Part 10** in relation to a relevant report, then the date by which that report must be provided to the QCA or published will be extended by twenty (20) Business Days.

10.6.2 Ringfencing audit

- (a) An audit of:
 - (i) Aurizon Network's compliance with its obligations under **Part 3**; and
 - (ii) other issues (to the extent that the QCA specifically requests that the Auditor consider such matters) for which the QCA reasonably believes that an audit is necessary,

must be conducted annually and as otherwise requested by the QCA (under **clause 10.6.3**) in accordance with **clause 10.6.4**.
- (b) In considering Aurizon Network's compliance with its obligations under **Part 3**, the Auditor may take into account Aurizon Network's compliance with any relevant internal procedures.
- (c) The Auditor will compile an audit report identifying whether Aurizon Network has complied in all material respects with its obligations under **Part 3** and, if not, details as to the relevant non-compliance.

10.6.3 Independent compliance audit

- (a) Despite any other provisions of this Undertaking that require the conduct of an audit:
 - (i) the QCA may request Aurizon Network in writing to, and on receipt of that request Aurizon Network must, engage an Auditor to undertake an audit in relation to whether any specific conduct or decisions of Aurizon Network comply with this Undertaking; and
 - (ii) at any time, the QCA, or the Chair of the Rail Industry Group on behalf of an Audit Majority of End Users may request Aurizon Network in writing to, and on receipt of that request Aurizon Network must (in accordance with the terms of this Undertaking), engage an Auditor to undertake an audit, in

relation to whether Aurizon Network has complied with its obligations under **clause 7A.11.1**.

- (b) An audit requested under **clause 10.6.3(a)** will be conducted in accordance with **clause 10.6.4**.
- (c) The Auditor will compile an audit report identifying:
 - (i) whether Aurizon Network has complied in all material respects with its obligations which were the subject of the requested audit and if not, details as to the relevant non-compliance; and
 - (ii) the process adopted for the conduct of the audit.
- (d) Costs incurred by Aurizon Network in complying with this **clause 10.6.3** and **clause 10.6.4** in relation to an audit will be incorporated in the Adjusted Allowable Revenue in accordance with **clause 4.3** of **Schedule F**, other than where the audit identifies a material non-compliance, in which case Aurizon Network's costs will be borne by Aurizon Network and those costs will not be incorporated in the Adjusted Allowable Revenue.
- (e) Costs of conducting an audit requested under this **clause 10.6.3** will be borne by the QCA in the event that it requests the audit (and recovered by means of the QCA levy), and otherwise by the End Users requesting the audit, other than where the audit identifies a material non-compliance in which case the costs of the Auditor will be borne by Aurizon Network and those costs will not be incorporated in the Adjusted Allowable Revenue.

10.6.4 *Audit process*

An audit process under this Undertaking (including an audit under **clause 10.6.3**) must be conducted in accordance with the following process:

- (a) in respect of:
 - (i) audits conducted under **clause 10.6.3(a)(ii)** Aurizon Network and an Audit Majority of End Users must jointly appoint a suitably qualified Auditor; or
 - (ii) all other audits, Aurizon Network will appoint an Auditor (or Auditors) who will be available to conduct audits required in accordance with this Undertaking. The appointment will be made by the date which is the earlier of:
 - (A) the date on which the first relevant audit is required under this Undertaking; and
 - (B) 1 year after the Approval Date;
- (b) if Aurizon Network and an Audit Majority of End Users have not agreed the appointment of an auditor under **clause 10.6.4(a)(i)** within 30 Business Days after the date of the request by the QCA or the Chair of the Rail Industry Group pursuant to **clause 10.6.3(a)(ii)**, the

QCA must appoint a suitably qualified Auditor by the date that is sixty (60) Business Days after the date of the request by the QCA or the Chair of the Rail Industry Group pursuant to **clause 10.6.3(a)(ii)**;

- (c) the Auditor must:
 - (i) be independent of Aurizon Network and all other Aurizon Parties;
 - (ii) be appropriately qualified and experienced (including have appropriate technical expertise in respect of audits conducted under **clause 10.6.3(a)(ii)**);
 - (iii) if applicable, having regard to the nature and scope of the relevant audit, be subject to professional standards of ethics and independence;
 - (iv) in respect of all audits other than the audits conducted under **clause 10.6.3(a)(ii)**, be approved by the QCA; and
 - (v) once appointed, the Auditor's appointment will be effective for the Term, subject only to the QCA having a right to require the appointment of a replacement Auditor in respect of all audits other than the audits conducted under **clause 10.6.3(a)(ii)**;
- (d) in respect of all audits other than the audits conducted under **clause 10.6.3(a)(ii)**, the Auditor will have a duty of care to the QCA in the provision of the audit and, in the event of a conflict between the Auditor's obligations to Aurizon Network and its duty of care to the QCA, the Auditor's duty of care to the QCA will take precedence;
- (e) in respect of all audits conducted under **clause 10.6.3(a)(ii)**, the Auditor will have a duty of care to the relevant End Users and Aurizon Network in the provision of the audit;
- (f) the Auditor for a financial matter may be different from the Auditor for another matter;
- (g) prior to commencing an audit, the Auditor must agree on an audit plan with Aurizon Network, document that audit plan, and obtain the QCA's approval of the audit plan;
- (h) the audit plan will:
 - (i) consist of a proposed work program for the execution of and scope of the audit, including audit costs;
 - (ii) where necessary, contain any procedural controls necessary to ensure the independence of the Auditor;
 - (iii) provide for the establishment of an audit liaison group, comprising the Auditor, Aurizon Network and the QCA, during the course of the audit, to provide a forum for the resolution of any audit issues that arise; and

- (iv) include a process for consultation with the QCA (and any relevant End Users and Aurizon Network in respect of all audits conducted under **clause 10.6.3(a)(ii)**) during the audit to ensure that the audit addresses the matters and standards required by the QCA or End Users (as the case may be) for the particular audit being conducted. The QCA may consult with Access Holders, End Users and Access Seekers over the matters and standards to be addressed in, and required of, the audit;
- (i) Aurizon Network must provide:
 - (i) any relevant information the Auditor reasonably requires for the purpose of conducting the audit, within a nominated timeframe that is determined by the Auditor to be reasonable after consultation with Aurizon Network; and
 - (ii) if an audit is required of the financial statements referred to in **clause 3.8**, access to Aurizon Network's financial records and information systems necessary for the purpose of conducting the audit;
- (j) the Auditor must enter into a confidentiality deed with Aurizon Network in relation to any information provided by Aurizon Network, to the effect that it must keep the information confidential and only use that information for the purpose of conducting the audit and completing the audit report, provided however that the Auditor will be entitled to provide:
 - (i) all information obtained as a result of the audit to the QCA; and
 - (ii) in respect of audits conducted under **clause 10.6.3(a)(ii)**, the audit results, with any confidential or commercially sensitive information redacted, to all End Users;
- (k) any drafts of an audit report that are provided to Aurizon Network by the Auditor must, at the same time, be provided to the QCA;
- (l) the Auditor will provide Aurizon Network and the QCA a copy of:
 - (i) the audit report; and
 - (ii) any letter or report from the Auditor accompanying the audit report which explains the audit findings in greater detail,
 both of which the QCA:
 - (iii) in respect of all audits other than audits conducted under **clause 10.6.3(a)(ii)**, may, if it considers it appropriate to do so, publish to parties thought appropriate by the QCA having regard to the scope of the audit and its findings;
 - (iv) in respect of audits conducted under **clause 10.6.3(a)(ii)**, must publish with any confidential or commercially sensitive

information redacted. Aurizon Network must promptly advise the relevant End Users once it receives the audit report;

- (m) in respect of all audits other than audits conducted under **clause 10.6.3(a)(ii)**:
 - (i) Aurizon Network must:
 - (A) prepare and provide to the QCA an implementation plan; and
 - (B) use reasonable endeavours, to implement the Auditor's recommendations in the audit report or any other letters or reports provided under **clause 10.6.4(l)**, including recommendations in relation to implementing new policies, practices or procedures directed to ensuring Aurizon Network satisfies the obligations set out in this Undertaking, as soon as reasonably practicable after receiving the Auditor's recommendations, except to the extent the non-implementation is approved by the QCA;
 - (ii) following the provision of an audit report under **clause 10.6.4(l)** and receipt of Aurizon Network's implementation plan under **clause 10.6.4(m)(i)**:
 - (A) QCA may, at its discretion, request that Aurizon Network provide evidence that it has used reasonable endeavours to implement any or all of the recommendations made by the Auditor in the relevant audit report in accordance with the implementation plan prepared under **clause 10.6.4(m)(i)**; and
 - (B) if Aurizon Network cannot provide such evidence to the satisfaction of the QCA (in its discretion), the QCA may direct Aurizon Network use reasonable endeavours to take the necessary actions required to implement the relevant recommendations within a specified timeframe; and
 - (iii) if Aurizon Network fails to comply with a direction issued by the QCA under **clause 10.6.4(m)(ii)**, on request from the QCA, Aurizon Network must provide all the documents and information in its possession that relate to its failure to comply with the direction given under **clause 10.6.4(m)(ii)**, to the QCA.
- (n) in respect of audits conducted under **clause 10.6.3(a)(ii)**, following the provision of an audit report under **clause 10.6.4(l)**, Aurizon Network will:

- (i) explain the extent to which it has implemented the recommendations made by the Auditor in the relevant audit report; and
- (ii) if it considers (acting reasonably) that it is neither prudent nor necessary to implement the Auditor's recommendations, reasonable reasons explaining Aurizon Network's decision to not implement those recommendations.

10.7 General

10.7.1 *Information provision*

- (a) Upon request by the QCA, Aurizon Network must provide to the QCA signed Access Agreements (including details of Access Charges) to allow the QCA to satisfy itself that the Below Rail aspects of the Access Agreement do not offend the provisions of this Undertaking or the Act.
- (b) In addition to **clause 10.7.1(a)**, the QCA may, by notice, request that Aurizon Network provide to the QCA information or a document that the QCA reasonably requires for the purpose of:
 - (i) performing its obligations or functions under this Undertaking; or
 - (ii) determining whether it should exercise powers in this Undertaking.

The notice must include a description of the information or document required, the purpose for which it is required, and the day by which it is required, provided that the day stated in the notice must be reasonable.

- (c) Except as provided for in **clause 10.7.1(d)**, Aurizon Network will permit the public disclosure of the Below Rail aspects of Access Agreements (including Access Charges) for all coal carrying Train Services for new or renewed Train Services except that the Below Rail aspects of Access Agreements will not include:
 - (i) the insurance provisions;
 - (ii) the contact details included in the Interface Coordination Arrangement;
 - (iii) the Rollingstock and Rollingstock Configuration performance characteristics;
 - (iv) the IRMP; and
 - (v) the Environmental Management Plan.
- (d) If a party to an Access Agreement considers that specified parts of the Access Agreement should not be publicly disclosed, it may make a request to the QCA for non-disclosure of those specified parts. The QCA must agree to the request if it is satisfied that disclosure of the

information would be likely to damage that party's commercial activities and that disclosure would not be in the public interest.

- (e) Aurizon Network must comply with a request by the QCA under **clause 10.7.1(a)** by the day stated in the notice, unless Aurizon Network has a reasonable excuse for noncompliance.
- (f) Except for documents that are to be made public in accordance with the terms of this Undertaking, nothing in this **clause 10.7** permits the QCA to disclose any information (including the contents of a document) provided to it under this **clause 10.7.1**.

10.7.2 Errors in reports

- (a) If a report has been published under this **Part 10** and Aurizon Network has actual knowledge of a material error in that report, Aurizon Network must, as soon as practicable but no later than three (3) Months after acquiring knowledge of the material error, publish on the Website either, at Aurizon Network's discretion, an erratum or a corrected report identifying the material errors. An error will be a material error where:
 - (i) if the error is a numerical error, the number reported deviates from the correct number by an amount of more than 2%; or
 - (ii) otherwise, Aurizon Network or the QCA considers the error to be material.
- (b) Aurizon Network must notify the QCA of any errors that Aurizon Network has actual knowledge of any report published under **Part 10** unless the QCA has otherwise been notified or is aware of the error.

10.7.3 Certifications required from Aurizon Network's Executive Officer

- (a) All certifications provided by Aurizon Network's Executive Officer under this Undertaking, including certifications of accuracy required in respect of financial statements and cost reports under this **Part 10**, are provided subject to **clause 10.7.3(b)**.
- (b) If in providing a certification required by this Undertaking Aurizon Network's Executive Officer relies on information or professional or expert advice, given or prepared by:
 - (i) Aurizon Network Personnel whom Aurizon Network's Executive Officer believes on reasonable grounds to be reliable and competent in relation to the matters concerned;
 - (ii) a professional adviser or expert in relation to matters that Aurizon Network's Executive Officer believes on reasonable grounds to be within the person's professional or expert competence;
 - (iii) another director or officer of Aurizon Network in relation to matters within the director's or officer's authority; or

- (iv) a committee of directors on which Aurizon Network's Executive Officer did not serve in relation to matters within the committee's authority and;
 - (A) the reliance was made:
 - (1) in good faith; and
 - (2) after making an independent assessment of the information or advice, having regard to Aurizon Network's Executive Officer's knowledge of Aurizon Network and the complexity of the structure and operations of Aurizon Network; and
 - (B) the reasonableness of Aurizon Network's Executive Officer's reliance on the information or advice arises in legal proceedings or an arbitration to determine whether Aurizon Network's Executive Officer has performed with due care and diligence in providing the certification,

Aurizon Network's Executive Officer's reliance on the information or advice is deemed to be reasonable unless the contrary is proved.

10.8 Provision of additional network performance information

10.8.1 *Intent*

Aurizon Network acknowledges that the purpose of the additional network performance reporting provided under this **clause 10.8** is to provide for complete, comprehensive and transparent reporting on the operation of the Rail Infrastructure including in order to assist the Independent Expert to make realistic assessments of Deliverable Network Capacity and System Capacity under **Part 7A**.

10.8.2 *Aurizon Network to provide performance information to Independent Expert*

- (a) Without limiting any other reporting obligations on Aurizon Network under this Undertaking, Aurizon Network must:
 - (i) until the date 12 Months after the Approval Date, by no later than 10 Business Days after the end of the relevant Month; and
 - (ii) at all times after 12 Months after the Approval Date, by no later than 5 Business Days after the end of the relevant Month,

to the extent known by Aurizon Network, provide the Independent Expert with comprehensive details of the following monthly network performance information (including all source and underlying information and data) as soon as reasonably practicable:

- (iii) a complete record for each Coal System of:
 - (A) all Train Services and Ad Hoc Train Services that were:
 - (1) requested;
 - (2) scheduled;
 - (3) delayed (including the period of any delay in minutes per 100 train kilometres);
 - (4) cancelled;
 - (5) requested of Aurizon Network in the ITP but not scheduled (whether or not requested within the scope of an Access Holder's Train Service Entitlements) by Aurizon Network in the DTP; and
 - (B) the extent to which the Train Services received by an Access Holder were less than their Nominated Monthly Train Services;
- (iv) the reason that each Train Service was delayed, cancelled or requested but not scheduled, or the Nominated Monthly Train Services were not provided, being one of:
 - (A) Operational Constraints (including Maintenance Work, Possession(s) or Infrastructure Enhancements) on the relevant Train Path(s); and
 - (B) any other reason;
- (v) if Train Services were delayed, cancelled or requested but not scheduled, or the Nominated Monthly Train Services were not provided, due to Possession(s):
 - (A) the type of Possession (whether a Planned Possession, Urgent Possession or Emergency Possession); and
 - (B) the reason for that Possession;
- (vi) if Train Services were delayed, cancelled or requested but not scheduled, or the Nominated Monthly Train Services were not provided, due to Maintenance Work or Asset Replacement and Renewal work (that falls outside of a Possession), reasonable detail of the circumstances giving rise to the need for that Maintenance Work or Renewal Work;
- (vii) for any Maintenance Work (both planned and unplanned), Asset Replacement and Renewal work and Possession(s):

- (A) the hours scheduled for that Maintenance Work, Asset Replacement and Renewal work or Possession(s) (if applicable);
 - (B) the actual hours spent carrying out that Maintenance Work, Asset Replacement and Renewal work or Possession(s) (including any hours additional to those that were scheduled);
 - (C) when that Maintenance Work, Asset Replacement and Renewal work or Possession(s) was performed;
 - (D) steps taken by Aurizon Network to minimise disruptions to Train Services when undertaking the relevant Maintenance Work, Asset Replacement and Renewal work or Possessions; and
 - (E) any further information relevant to assessing whether Aurizon Network has complied with its obligations under **clause 7A.3** and **7A.11.1**;
- (viii) a record of any variation made to the DTP;
 - (ix) where any variation was made to the DTP, information about the underlying reasons for that change (in sufficient detail so as to understand the underlying reasons for the change), including evidence of any consultation with affected Access Holders if required under the terms of this Undertaking;
 - (x) information reasonably requested of Aurizon Network in relation to availability of other aspects of the Supply Chains for that Coal System, including loading facilities, load out facilities and coal export terminal facilities;
 - (xi) copies of all Access Agreements and Train Operations Deeds held by Aurizon Network;
 - (xii) information relating to any Expansions;
 - (xiii) any other information relating to constraints affecting the Rail Infrastructure;
 - (xiv) information on the safety of Train Services that have operated in that Month, being the number of major reportable incidents, as reported to the Safety Regulator;
 - (xv) information on the transit times of Train Services, being the time from origin to destination, that operated during that Month;
 - (xvi) information on the availability of the network for Train Services in that Month having regard to the whole of that Coal System (including the mainlines, branch lines, loading facilities, load out facilities and coal export terminal facilities);

- (xvii) information on network service quality, as follows:
 - (A) speed restrictions in that Month, being the average percentage and the average number of kilometres of Track under temporary speed restriction; and
 - (B) the most recent measure of Track quality for the network measured by a quality index with component measures including gauge, top, twist and versine;
 - (xviii) information on coal carrying Train Services that have operated in that Month, being:
 - (A) the aggregate gtk;
 - (B) the aggregate nt;
 - (C) the aggregate ntk;
 - (D) the aggregate egtk;
 - (E) the actual Below Rail Transit Time Percentage (including the methodology for calculating that percentage);
 - (F) the required Below Rail Transit Time Percentage (including the methodology for calculating that percentage);
 - (G) the aggregate Train Paths used by the relevant Train Services;
 - (H) the aggregate Train Paths contracted for relevant Train Services in accordance with the relevant Train Service Entitlements;
 - (I) the aggregate number of Train Paths available for coal carrying Train Services;
 - (J) the aggregate number of Train Paths that were available but not used;
 - (xix) information on the outcome of the Contested Train Path decision making process contained in **clause 8** of **Schedule G** in respect of:
 - (A) the number of contests run each Month; and
 - (B) the number and percentage of Train Paths allocated under each of the Contested Train Path principles set out in **clause 8.3** of **Schedule G**; and
 - (xx) any other information reasonably requested by the Independent Expert in connection with its functions.
- (b) Aurizon Network's obligation to provide the information referred to in **clauses 10.8.2(a)(iii), 10.8.2(a)(v), 10.8.2(a)(vii)(A)** (in so far as it

relates to the hours scheduled for that Maintenance Work),
10.8.2(a)(ix) and **10.8.2(a)(xvi)** commences 3 Months after the Approval Date.

10.8.3 *Independent Expert to provide monthly network performance report*

- (a) Using the information received from Aurizon Network under **clause 10.8.2(a)**, the Independent Expert must provide Aurizon Network, Access Holders, their Customers (if applicable) and Train Operators with a Monthly report that contains the additional network performance information for each Coal System detailed in **clause 10.8.3(c)**:
- (i) as soon as reasonably practicable, and by no later than 15 Business Days after the end of the relevant Month; and
 - (ii) subject to **clause 10.8.3(c)**, in a form that does not:
 - (A) reveal the identity of any individual Access Holder, Customer or Train Operator; and
 - (B) disclose any information that is commercially sensitive to an Access Holder, Customer or Train Operator,including by aggregating data to the extent necessary to comply with **clause 10.8.3(a)(ii)(A) to (B)**.
- (b) For the purpose of **clause 10.8.3(a)**, any Access Holder, Customer or Train Operator may provide its prior written consent to Aurizon Network for its identity and commercially sensitive information to be disclosed in the Monthly report.
- (c) The Monthly report must include:
- (i) a complete record of:
 - (A) all Train Services and Ad Hoc Train Services that were:
 - (1) requested;
 - (2) scheduled;
 - (3) delayed (including the period of any delay in minutes per 100 train kilometres);
 - (4) cancelled;
 - (5) requested of Aurizon Network but not scheduled (whether or not requested within the scope of an Access Holder's Train Service Entitlements); and
 - (B) the extent to which Access Holders have received their Nominated Monthly Train Services;

- (ii) for any Train Service or Ad Hoc Train Service that was delayed, cancelled or not scheduled, or in respect of any Access Holder who has not received their monthly Train Service Entitlements, a root cause analysis of the underlying reasons for that Train Service or Ad Hoc Train Service being delayed, cancelled or not scheduled, or for the Access Holder's Nominated Monthly Train Services not being provided, including the party responsible, having regard to the information provided by Aurizon Network under **clause 10.8.2(a)**;
- (iii) for any Maintenance Work (both planned and unplanned), Asset Replacement and Renewal work and Possession(s):
 - (A) the reasons for that Maintenance Work, Asset Replacement and Renewal work or Possession(s);
 - (B) the hours scheduled for that Maintenance Work, Asset Replacement and Renewal work or Possession(s) (if applicable);
 - (C) the actual hours spent carrying out that Maintenance Work, Asset Replacement and Renewal work or Possession(s) (including any hours additional to those that were scheduled);
 - (D) when that Maintenance Work, Asset Replacement and Renewal work or Possession(s) was performed; and
- (iv) information regarding Aurizon Network's compliance with its obligations under **clause 7A.3.1(a)(ii)** and **7A.11.1**;
- (v) information on the availability of the network for Train Services in that Month having regard to the whole of that Coal System (including the mainlines, branch lines, loading facilities, load out facilities and coal export terminal facilities);
- (vi) information on the average transit times of Train Services that operated during that Month, as follows:
 - (A) the average Above Rail Delay;
 - (B) the average Below Rail Delay; and
 - (C) the average Unallocated Delay,

in minutes per 100 train kilometres, for all Train Services.
- (vii) information on network service quality, as follows:
 - (A) speed restrictions in that Month, being the average percentage and the average number of kilometres of Track under temporary speed restriction; and

- (B) the most recent measure of Track quality for the network measured by a quality index with component measures including gauge, top, twist and versine;
 - (viii) information on coal carrying Train Services that have operated in that Month, being:
 - (A) the aggregate gtk;
 - (B) the aggregate nt;
 - (C) the aggregate ntk;
 - (D) the aggregate egtk;
 - (E) the actual Below Rail Transit Time Percentage (including the methodology for calculating that percentage);
 - (F) the required Below Rail Transit Time Percentage (including the methodology for calculating that percentage);
 - (G) the aggregate Train Paths used by the relevant Train Services;
 - (H) the aggregate Train Paths contracted for relevant Train Services in accordance with the relevant Train Service Entitlements;
 - (I) the aggregate number of Train Paths available for coal carrying Train Services;
 - (J) the aggregate number of Train Paths that were available but not used and information regarding why those Train Paths were not useable (having regard to mainlines, branch lines and load out points);
 - (ix) information on the outcome of the Contested Train Path decision making process contained in **clause 8 of Schedule G** in respect of:
 - (A) the number of contests run each Month; and
 - (B) the number and percentage of Train Paths allocated under each of the Contested Train Path principles set out in **clause 8.3 of Schedule G**; and
 - (x) such other reports reasonably required by a Majority of End Users in a Coal System.
- (d) The Independent Expert must promptly provide the Monthly report required under **clause 10.8.3** to the QCA on an unredacted basis, and by no later than the timeframe provided under **clause 10.8.3(a)(i)**.

10.8.4 *Independent Expert to provide additional monthly performance report to each Access Holder and Customer*

- (a) Using the information received from Aurizon Network under **clause 10.8.2**, the Independent Expert must provide each Access Holder and their Customers (if applicable) with a Monthly report that contains the information detailed in **clause 10.8.4(b)** as soon as reasonably practicable, and by no later than 15 Business Days after the end of the relevant Month.
- (b) The Monthly report must include:
 - (i) in respect of the relevant Access Holder, a complete record of:
 - (A) all Train Services and Ad Hoc Train Services that were:
 - (1) requested;
 - (2) scheduled;
 - (3) delayed (including the period of any delay in minutes per 100 train kilometres);
 - (4) cancelled;
 - (5) requested but not scheduled (whether or not requested within the scope of that Access Holder or Customer's Train Service Entitlements); and
 - (B) the extent to which that Access Holder has received its Nominated Monthly Train Services; and
 - (ii) for any Train Service or Ad Hoc Train Service that was delayed, cancelled or not scheduled, and if that Access Holder has not received its monthly Train Service Entitlements, a root cause analysis of the underlying reasons for that Train Service or Ad Hoc Train Service being delayed, cancelled or not scheduled, or for the Access Holder's Nominated Monthly Train Services not being provided, including the party responsible, having regard to the information provided by Aurizon Network under **clauses 10.8.2(a)(iv) – 10.8.2(a)(xii)**.

10.8.5 *Independent Expert can request Aurizon Network to prepare reports*

Aurizon Network acknowledges that, until the date that is 12 Months after the Approval Date, the Independent Expert may (acting reasonably) request Aurizon Network to provide a Monthly report to the QCA, Access Holders, their Customers (if applicable) and Train Operators on any of the information it has provided or is required to provide to the Independent Expert under **clause 10.8.2**, provided that Aurizon Network will be entitled to recover its reasonable additional costs of preparing any report under this **clause 10.8.5** to the extent

that Aurizon Network would not have incurred those costs had the reporting obligations been the same as those under the 2016 Undertaking.

Part 11: Dispute Resolution and Decision Making

11.1 Dispute Resolution

11.1.1 Disputes

- (a) Any dispute:
- (i) as between Aurizon Network and a Prospective Access Seeker, Access Seeker or a Railway Operator in relation to:
 - (A) the negotiation or grant of Access; or
 - (B) the negotiation of a Train Operations Deed;
 - (ii) in relation to the operation of, or anything required to be done or not done by Aurizon Network under this Undertaking; or
 - (iii) in respect of any matters expressly required by this Undertaking to be resolved in accordance with this **Part 11**, provided the dispute is not vexatious or an abuse of process (**Dispute**), must be resolved in accordance with this **Part 11** and any party to the Dispute may give to the other party or parties a Dispute Notice.
- (b) For clarity, any Dispute in relation to the entry into and completion of schedules for any Standard Agreement, or agreement substantially in the form of a Standard Agreement, is a Dispute for the purpose of **clause 11.1.1(a)** and must be resolved in accordance with this **Part 11**. Notwithstanding **clause 11.1.1(a)**, a dispute regarding a party refusing to vary the terms of a Standard Agreement:
- (i) for coal carrying Train Services is not a Dispute; and
 - (ii) to reflect the fact that the Access is for non-coal carrying Train Services is a Dispute,
- for the purpose of **clause 11.1.1(a)**.
- (c) Unless otherwise agreed by the parties in writing, any disputes arising in respect of any right or obligation under (or the enforcement of) an Access Agreement, a Train Operations Deed, a Studies Funding Agreement, a User Funding Agreement or a Rail Connection Agreement must be dealt with in accordance with the provisions of that agreement (even if the Dispute relates to provisions included in that agreement that are similar to, required by, or inconsistent with this Undertaking) and are not to be dealt with under this Undertaking.
- (d) For the avoidance of doubt, disputes between parties to an Access Agreement, a Train Operations Deed, a Studies Funding Agreement, a User Funding Agreement or a Rail Connection Agreement may be dealt with under this Undertaking to the extent the dispute does not relate to any right or obligation under (or the enforcement of) the

Access Agreement, the Train Operations Deed, the Studies Funding Agreement, the User Funding Agreement or the Rail Connection Agreement.

- (e) For the purposes of this **clause 11.1**, where:
- (i) a Dispute involves a Prospective Access Seeker, Access Seeker, Access Holder or Customer who is not also a Railway Operator; or
 - (ii) a Dispute involves a Railway Operator,
- then:
- (iii) either Aurizon Network or the other initial party to the Dispute must provide the relevant Railway Operator(s) (where **paragraph (i)** applies) or the relevant Prospective Access Seeker, Access Seeker, Access Holder or Customer (where **paragraph (ii)** applies) to whom the Dispute, or the outcome or consequences of the Dispute is relevant with a copy of the Dispute Notice in connection with the Dispute; and
 - (iv) any such Prospective Access Seeker, Access Seeker, Access Holder, Customer or Railway Operator, as applicable, may elect, by giving notice to Aurizon Network and the other parties to the Dispute within five (5) Business Days after receiving the Dispute Notice under **clause 11.1.1(e)(iii)**, to become a party to the Dispute for the purposes of **clauses 11.1.2 to 11.1.6**, provided the joinder to the Dispute is not vexatious or an abuse of process..
- (f) All parties to, and other persons involved in resolving, a Dispute must use reasonable endeavours to facilitate the resolution of the Dispute in a timely manner.

11.1.2 Chief executive resolution

- (a) Unless otherwise agreed in writing by the parties to the relevant Dispute, any Dispute must, within five (5) Business Days of the receipt of a Dispute Notice, be referred in the first instance to each party's chief executive (or his or her nominee) for resolution.
- (b) Within ten (10) Business Days after a Dispute Notice is given (or as agreed in writing by the parties to the relevant Dispute), the chief executive (or his or her nominee) of each party referred to in **clause 11.1.2(a)** must meet to resolve the Dispute.
- (c) All communications between the parties to a Dispute, including by, to or through each party's chief executive (or his or her nominee), as part of an attempt to resolve the Dispute under this **clause 11.1.2** are made on a without prejudice and confidential basis.

- (d) Where the Dispute is resolved under this **clause 11.1.2**, Aurizon Network must promptly notify the QCA of the resolution and provide a copy of that notice to the other parties to the Dispute.
- (e) If the Dispute is not resolved within ten (10) Business Days after the chief executive (or his or her nominee) of each party first meet in accordance with **clause 11.1.2(b)**, the parties may agree to refer the Dispute to:
 - (i) mediation to be resolved in accordance with **clause 11.1.3**;
 - (ii) an expert to be resolved in accordance with **clause 11.1.4**;
or
 - (iii) the QCA to be resolved in accordance with **clause 11.1.5**,and, failing agreement under this **clause 11.1.2(e)** within fifteen (15) Business Days after the chief executive (or his or her nominee) of each party first meet in accordance with **clause 11.1.2(b)**, any party may refer the Dispute to the QCA to be resolved in accordance with **clause 11.1.5**.

11.1.3 Mediation

- (a) If the parties agreed to refer the relevant Dispute to mediation, then the mediation must be administered by the Australian Commercial Disputes Centre (**ACDC**) in accordance with ACDC's guidelines for mediation. The costs charged by ACDC for the mediation must be borne equally by the parties and each party must bear its own costs of preparing for and attending the mediation.
- (b) All communications made between the parties to a Dispute, including to or through the mediator, as part of an attempt to resolve the Dispute under this **clause 11.1.3** are made on a without prejudice and confidential basis.
- (c) Where mediation resolves the Dispute, the resolution must be documented in writing and signed by the parties to the Dispute. The mediator must provide a copy of the agreement by which the Dispute was resolved to the QCA. If the mediator fails to do so, Aurizon Network must provide a copy of the agreement to the QCA.
- (d) If the matter is referred to mediation under **clause 11.1.3(a)** and either:
 - (i) the mediator notifies the parties to the mediation that the mediator considers:
 - (A) the parties to the relevant mediation cannot achieve a mediated resolution of the Dispute; or
 - (B) a party to the relevant mediation has failed to participate in the mediation process in good faith; or

- (ii) mediation fails to resolve the Dispute within four (4) Months after the matter is referred to mediation under **clause 11.1.3(a)**,

then the parties may agree to refer the Dispute to:

- (iii) an expert to be resolved in accordance with **clause 11.1.4**;
or
- (iv) the QCA to be resolved in accordance with **clause 11.1.5**,

and, failing agreement under this **clause 11.1.3(d)** within five (5) Business Days after the notification under **clause 11.1.3(d)(i)** or after the expiry of the period under **clause 11.1.3(d)(ii)**, whichever is relevant, any party may refer the Dispute to the QCA to be resolved in accordance with **clause 11.1.5**.

11.1.4 Expert determination

- (a) Where:

- (i) the parties to a Dispute agree to refer a matter to an expert for determination, and
- (ii) the Dispute is referred to the chief executives (or their nominee) and has not been resolved under **clause 11.1.2**,
the dispute must be referred to the expert for determination in accordance with this **clause 11.1.4**.

- (b) Where a Dispute is referred to an expert:

- (i) the expert must be:
 - (A) appointed by agreement between the parties to the Dispute; or
 - (B) in default of such appointment within ten (10) Business Days after the requirement or right (as applicable) to refer the matter to an expert arose, the person nominated by (at request of any party to the Dispute):
 - (1) If the parties agree that the dispute is purely of a financial or accounting nature, the President (for the time being) of Chartered Accountants Australia and New Zealand;
 - (2) If the parties agree that the dispute is purely of a technical nature, the President (for the time being) of the Resolution Institute; or
 - (3) In any other case (including where the parties are unable to agree on the nature of the Dispute), the President (for the time being) of the Queensland Law Society Incorporated;

- (ii) if the person referred to in **clause 11.1.4(b)(i)(B)** declines to nominate a person as the expert but provides a list of people that could be appointed as the expert, then:
 - (A) the first person specified in that list will be taken to be nominated as the Expert;
 - (B) if the first person specified in that list does not accept the appointment as the Expert, then the next person specified in that list will be taken to be nominated as the Expert; and
 - (C) the process specified in **clause 11.1.4(b)(ii)(B)** will apply to the next and each subsequent person specified in that list until a person that is taken to be nominated as the Expert accepts the appointment as the Expert;
- (iii) subject to **clause 11.1.4(b)(ii)**, if the expert is to be nominated by a person referred to in **clause 11.1.4(b)(i)(B)** and the person nominated as the expert does not accept appointment as the expert, then an alternative person is to be nominated as the expert at the request of any party to the Dispute by the relevant person referred to in **clause 11.1.4(b)(i)(B)**;
- (iv) any determination by an expert under this **clause 11.1.4** must not commence, unless and can only be made if, all of the parties to the Dispute agree (in a legally binding way):
 - (A) to be bound by the outcome of the expert determination subject to **clause 11.1.4(h)**;
 - (B) how costs and disbursements of the expert determination will be paid as contemplated by **clause 11.1.4(i)**; and

the parties to the Dispute must act reasonably and in good faith to reach agreement as soon as reasonably practicable.
- (v) the parties to the Dispute must comply with, and do all things necessary to satisfy and to give effect to, the reasonable requirements of an agreed or nominated expert (including providing relevant indemnities and paying any charges or fees, which charges or fees will, subject to any agreement to the contrary, be borne by the parties in equal shares) that must be satisfied or complied with as a condition of that person accepting the appointment as an expert;
- (vi) the expert must:
 - (A) have appropriate qualifications and practical experience having regard to the nature of the Dispute;

- (B) have no interest or duty which conflicts or may conflict with their function as expert, the expert being required to fully disclose any such interest or duty by notice to the parties before their appointment;
- (C) not be, or have been in the last five (5) Years, an employee of any of the parties to the Dispute or of a Related Party of any of them;
- (D) not be permitted to act until the expert has given notice to each party that the expert is willing and able to accept the appointment;
- (E) have regard to the provisions of this Undertaking and consider all submissions (including oral submissions by each party provided that such oral submissions are made in the presence of the other parties to the Dispute), supporting documentation, information and data with respect to the matter submitted by the parties;
- (F) not make a determination in relation to a Dispute that is inconsistent with:
 - (1) this Undertaking;
 - (2) Aurizon Network's Safety Management System; or
 - (3) Aurizon Network's obligations arising under applicable safety or environmental legislation including the Rail Safety Act;
- (G) have regard to the matters specified in section 120(1)(a) to (l) of the Act;
- (H) provide to the parties a copy of the expert's determination in relation to the Dispute in the form of a report setting out reasonable details of the reasons for the expert's determination within a reasonable time after their appointment;
- (I) be required to undertake to keep confidential all matters coming to their knowledge by reason of their appointment and performance of their duties (including, if required by a party, by entering into a confidentiality agreement in favour of the parties to the relevant Dispute); and
- (J) be deemed to be and must act as an expert and not an arbitrator and the law relating to arbitration (including the *Commercial Arbitration Act 2013* (Qld)), does not apply to the expert or to the

determination or the procedures by which the expert may reach a determination.

- (c) For clarity, an expert may make a determination relating to:
- (i) the interpretation or application of any provision of this Undertaking; or
 - (ii) whether a party has complied with the terms of this Undertaking,
- where the interpretation or application of this Undertaking or compliance with this Undertaking is the matter that is in dispute.
- (d) Any Dispute subject to expert determination under this **clause 11.1.4** must be determined in accordance with the Expert Determination Rules of the Resolution Institute to the extent those rules are not inconsistent with the terms of this **clause 11.1.4**.
- (e) If, at any time during the determination, the expert becomes aware of circumstances that might reasonably be considered to adversely affect the expert's capacity to act independently or impartially, the expert must:
- (i) inform the parties to the Dispute immediately;
 - (ii) unless the parties to the Dispute agree otherwise in writing, terminate the engagement; and
- in which case any determination of the expert will be of no effect and a new expert must be appointed in accordance with the procedure outlined in this **clause 11.1.4**.
- (f) The parties must do everything reasonably requested by the expert to assist the expert in determining the Dispute, including providing or making available to the expert, as soon as reasonably practicable, all information and materials in their possession or control requested by the expert and attending any hearing convened by the expert.
- (g) If the parties to a Dispute agree it is appropriate to appoint multiple experts to determine the Dispute, each expert must:
- (i) cooperate with the other experts appointed to determine the Dispute;
 - (ii) endeavour to reach a unanimous determination with the other appointed experts; and
 - (iii) agree with the other appointed experts the procedure for drafting the written determination.
- (h) Subject to compliance by the expert with **clause 11.1.4(e)** and in the absence of fraud or manifest error, the expert's determination is final and binding as between the parties in relation to the subject matter of the Dispute. If a party believes that there has been a manifest error or fraud in the expert's determination or that the expert has not

complied with **clause 11.1.4(e)**, it may refer the matter to the QCA for a determination. If the QCA determines that there has been a manifest error or fraud or that the expert has not complied with **clause 11.1.4(e)**, the expert's determination is not binding and:

- (i) the parties may agree to refer the Dispute to another expert in accordance with this **clause 11.1.4**; or
 - (ii) failing such agreement, any party may request the QCA to resolve the Dispute in accordance with **clause 11.1.5**.
- (i) Unless otherwise agreed by the parties to the Dispute:
- (i) the following must be borne by the parties in equal shares:
 - (A) the costs of the expert (and the costs of any advisers to the expert), including fees and disbursements; and
 - (B) any transcript fees;
 - (ii) each party must bear their own costs of and incidental to participating in the expert determination process, including their own costs of and incidental to the preparation of a confidentiality deed or agreement for the engagement of the expert.
- (j) An expert appointed under this **clause 11.1.4** must not, without the prior written consent of the parties to the Dispute, accept an appointment to act as arbitrator, or act as an advocate or adviser to any party, in any subsequent arbitral or judicial proceedings arising out of or in connection with the Dispute.

11.1.5 Determination by the QCA

- (a) If this Undertaking requires that a Dispute be resolved by the QCA under this **clause 11.1.5**, then that Dispute may only be referred to the QCA after **clause 11.1.2** has been complied with in relation to that Dispute.
- (b) Despite this Undertaking requiring a Dispute to be resolved by the QCA, the parties may jointly request the QCA to refer the matter to an expert for determination in accordance with **clause 11.1.4** in which case the QCA (having regard to the object of Part 5 of the Act, as set out in section 69E of the Act) may, but is not required to, refer the matter to an expert.
- (c) If a Dispute is referred to the QCA, then:
 - (i) if the Dispute does not constitute a dispute for the purposes of Division 5 of Part 5 of the Act and is not a dispute about Access:
 - (A) any determination of the Dispute by the QCA must not commence unless, and can only be made if, all of the parties to the Dispute agree (in a legally

- binding way) to be bound by the outcome of the Dispute and any order the QCA makes requiring a party to pay any other party's costs of the Dispute;
- (B) the parties to the Dispute must act reasonably and in good faith to reach the agreement required by **clause 11.1.5(c)(i)(A)** as soon as reasonably practicable;
 - (C) the QCA may make a determination through any process that it considers appropriate provided that prior to considering the Dispute, the QCA advises the parties to the Dispute of the process that it intends to use to make the determination, having regard to the processes in Division 5 of Part 5 of the Act, and the parties are given the opportunity to advise the QCA of any concerns with that process;
 - (D) despite **clause 11.1.5(c)(i)(C)** the QCA must not make a determination that is inconsistent with Division 5 of Part 5 of the Act, the provisions of this Undertaking or section 119 of the Act (unless the parties agree and no party (whether a party to the Dispute or not) is adversely affected).
- (ii) if the Dispute is a dispute for the purposes of Division 5 of Part 5 of the Act or is otherwise a dispute about Access, any determination of that Dispute must occur subject to, and in accordance with, Division 5 of Part 5 of the Act and Part 7 of the Act.
- (d) Any referral of a Dispute to the QCA must be accompanied by a Dispute Notice setting out the information required by section 113 of the Act.
 - (e) If a Dispute is referred to the QCA in accordance with this Undertaking, the QCA must provide notices of the Dispute to the parties specified in section 114 of the Act.
 - (f) If a Dispute is referred to the QCA in accordance with this Undertaking:
 - (i) The QCA must seek the advice of the Safety Regulator on any aspect of the Dispute that any party to the Dispute or the QCA considers to be a safety related matter and must not make any decision that is inconsistent with advice it receives from the Safety Regulator to the extent that the advice relates to any aspect of safety. The QCA must provide to the parties a copy of any advice it receives from the Safety Regulator.
 - (ii) If the Dispute does not constitute a Dispute for the purposes of Division 5, Part 5 of the Act and is not a dispute about

Access, the QCA must not make a decision which is inconsistent with Aurizon Network's Safety Management System or Aurizon Network's obligations arising under applicable safety or environmental legislation including the Rail Safety Act.

11.1.6 Procedure

- (a) Where a Dispute is referred to either an expert or the QCA (**decision maker**) for determination:
 - (i) each party to the Dispute must provide written submissions to the decision maker outlining its views on the matter(s) in dispute, including reasons why its views should be preferred and an outline of how it would like to see the Dispute resolved;
 - (ii) each party to a Dispute will be provided with a reasonable opportunity to respond to submissions made to the decision maker by each other party; and
 - (iii) where the matter in dispute arises under a provision of this Undertaking which sets out the relevant matters to be taken into account by Aurizon Network or the decision maker in making its determination, the submissions to the decision maker by the parties to the Dispute must address those matters.
- (b) The decision maker's determination is final and binding upon the parties to the Dispute who must comply with the determination of the decision maker, unless:
 - (i) in the case of an expert, the QCA determines that the expert's determination is not binding under **clause 11.1.4(h)**; or
 - (ii) a determination by the QCA is successfully challenged on the basis of a breach of a requirement in **clause 11.2**.

11.1.7 Application to Part 8 Disputes

- (a) **Part 8** expressly sets out additional requirements in relation to resolution of specified Disputes.
- (b) **Part 8** prevails to the extent of any inconsistency with this Part 11.

11.2 QCA decision-making

- (a) The QCA may not make a decision (**Decision**) under this Undertaking (including a determination under this **Part 11**) that may affect Aurizon Network (including to require Aurizon Network to do, give or submit anything to the QCA, to resolve a Dispute or to refuse to approve, approve or consent to or grant anything), unless:
 - (i) the QCA observed the rules of natural justice;

- (ii) the QCA observed any procedures that were required by law or this Undertaking;
- (iii) the QCA had jurisdiction to make the Decision under this Undertaking;
- (iv) the QCA was authorised to make the Decision under this Undertaking;
- (v) the QCA's Decision would not be an improper exercise of the power conferred by this Undertaking. An improper exercise of power includes a reference to:
 - (A) taking an irrelevant consideration into account in the exercise of a power;
 - (B) failing to take a relevant consideration into account in the exercise of a power;
 - (C) an exercise of a power for a purpose other than a purpose for which the power is conferred;
 - (D) an exercise of a discretionary power in bad faith;
 - (E) an exercise of a personal discretionary power at the discretion or behest of another person;
 - (F) an exercise of a discretionary power in accordance with a rule or policy without regard to the merits of a particular case;
 - (G) an exercise of a power that is so unreasonable that no reasonable person could so exercise the power;
 - (H) an exercise of a power in such a way that the result of the exercise of the power is uncertain; and
 - (I) any other exercise of a power in a way that is an abuse of the power;
- (vi) the QCA's Decision did not involve an error of law (whether or not the error appears on the record of the Decision);
- (vii) the QCA's Decision was not induced or affected by fraud;
- (viii) to the extent that any matters were required to be established before the Decision could be made or taken, there was some material or evidence from which the QCA could reasonably be satisfied the matter was established to justify the Decision or, to the extent that the existence of a particular fact forms the basis on which the Decision is made, the fact did or does exist; and
- (ix) the Decision was not otherwise contrary to law or this Undertaking. For the avoidance of doubt, the terms of this **clause 11.2(a)** are intended to have the same meaning as used in the *Judicial Review Act 1991* (Qld).

- (b) If the QCA's Decision or conduct is challenged on the basis of a breach of a requirement in this **clause 11.2**, Aurizon Network and the QCA agree that Aurizon Network may seek an order suspending the operation of the Decision and a stay of any proceedings under the Decision.
- (c) This **clause 11.2** does not affect the right of any party to seek any other form of remedy or relief including relief by way of the equitable remedies of injunction or declaration or to seek review under the *Judicial Review Act 1991* (Qld).

Part 12 Definitions and Interpretation

12.1 Definitions

In this Undertaking these terms have the following meanings:

\$/ntk	Converted to a single \$/nt value on the basis of the applicable Nominal Train Payload.
2001 Undertaking	The access undertaking prepared by Queensland Rail and approved by the QCA pursuant to the Act which commenced on 1 March 2002 (as amended during the term of that access undertaking).
2005 Undertaking	The access undertaking prepared by Queensland Rail and approved by the QCA pursuant to the Act which commenced on 30 June 2006 (as amended during the term of that access undertaking).
2008 Undertaking	The access undertaking prepared by Aurizon Network (previously named QR Network Pty Ltd) and approved by the QCA pursuant to the Act which commenced on 23 October 2008 (as amended during the term of that access undertaking).
2010 Undertaking	The access undertaking prepared by Aurizon Network and approved by the QCA pursuant to the Act which commenced on 1 October 2010 (as amended during the term of that access undertaking).
2016 Undertaking	The access undertaking prepared by Aurizon Network and approved by the QCA pursuant to the Act which was approved on 11 October 2016 (as amended during the term of that access undertaking).
5 Year Forecast Period	At the relevant time, a period of 5 (five) years commencing at the start of the following Year.
Above Rail Delay	A delay to a Train Service from its scheduled Train Path in the DTP, where that delay can be attributed directly to an Access Holder (including, if applicable, its Nominated Railway Operator) in operating its Train Services, but excludes: <ul style="list-style-type: none">(a) cancellations;(b) delays resulting from compliance with a Passenger Priority Obligation; and(c) delays resulting from a Force Majeure Event.
Above Rail Services	Those activities, other than Below Rail Services, required to provide and operate Train Services (which includes

Rollingstock provision for providing Train Services, maintenance of that Rollingstock, non Network Control related communications, train crewing, terminal provision and services, freight handling and marketing and administration of those services) and **Above Rail** has a similar meaning.

Absolute Capacity

The maximum number of Train Paths (calculated on a Monthly and annual basis) that can be provided:

- (a) in each Coal System; and
- (b) for the mainline and each branch line of each Coal System,

using the following assumptions:

- (c) the Rail Infrastructure is not affected by maintenance, renewal or Expansion activities;
- (d) there are no speed restrictions affecting the Rail Infrastructure;
- (e) there are sufficient origins and destinations, and sufficient infrastructure at those origins and destinations, to enable all Train Paths to be utilised;
- (f) there are no delays or failures occurring in the relevant Supply Chain;
- (g) there is sufficient rollingstock and other above rail assets to enable all Train Paths to be utilised; and
- (h) the minimum headway of the relevant Coal System.

Access

The non-exclusive utilisation of a specified section of Rail Infrastructure for the purposes of operating Train Services including, to the extent necessary for the operation of Train Services:

- (a) the use of passing loops and Train queuing and staging including before and after loading and unloading of Trains;
- (b) the loading and unloading of Trains at facilities that are Rail Infrastructure;
- (c) Train marshalling and shunting:
 - (i) in preparation for running of a Train Service;
 - (ii) before or after loading or unloading of a Train; and
 - (iii) before or after maintenance and provisioning of a Train;

- (d) Stowage;
- (e) the benefit of other Below Rail Services essential to the use of the Rail Infrastructure such as:
 - (i) signalling;
 - (ii) Network Control Services and associated communication;
 - (iii) access to walkways immediately adjacent to, and crew changeover points connecting to, Track; and
 - (iv) providing the use of electric transmission infrastructure on electrified sections of the Track, and the sale and supply of electric energy, so as to permit the acquisition of electric energy for traction; and
- (f) entry upon land:
 - (i) to the extent that entry upon the land is incidental to and essential for the use of Rail Infrastructure; or
 - (ii) for access to walkways and crew changeover points referred to in **paragraph (e)(iii)** of this definition to the same degree as is available to Related Operators,

provided that:

 - (iii) the land is owned by Aurizon Network, or Aurizon Network has, through a lease, licence or other arrangement with the owners of the land or in accordance with the TIA, the authority to authorise access to that land; and
 - (iv) the entry is not inconsistent with the terms of any lease, licence or other arrangement to which Aurizon Network is a party in respect of the land.

Access Agreement

An agreement between Aurizon Network and an Access Holder for the provision of Access.

Access Application

A written request for Access:

- (a) using the application form for such requests published on the Website from time to time; and
- (b) which satisfies:
 - (i) the information requirements set out in **Schedule B** and **Part 4**; and

- (ii) any additional information, evidence or clarification requested by Aurizon Network in accordance with **Part 4**,

(except to the extent that the Non-availability Circumstances exist, in which case the Access Application must specify this extent), but does not include a request to enter into a Train Operations Deed.

Access Charge

The price paid to Aurizon Network for Access under an Access Agreement and for clarity includes:

- (a) any:
 - (i) Take or Pay charges;
 - (ii) revenue cap adjustments;
 - (iii) charges and penalties associated with the operation of a Train Service on the Rail Infrastructure (including, for example, overload charges); and
- (b) amounts paid to Aurizon Network in accordance with any Access Conditions, Studies Funding Agreement, User Funding Agreement or Rail Connection Agreement, where such amounts are included in the cost build up for Reference Tariffs or are otherwise included in Access Charges for Train Services.

Access Charge Rates

For a Train Service Type, the rates specified in the Access Agreement for that Train Service Type.

Access Conditions

Conditions which are additional to those in the Standard Access Agreement (which conditions are not immaterial), whether the conditions are contained in an Access Agreement or a separate agreement, including conditions requiring;

- (a) an upfront contribution;
- (b) a payment of an Access Facilitation Charge;
- (c) a prepayment of all or part of an Access Facilitation Charge;
- (d) a bank guarantee or other security that is unconditional, irrevocable, payable on demand and otherwise in a form acceptable to Aurizon Network, acting reasonably, to support payment of an amount not reflected in the Standard Access Agreement (including, for example, payment of an Access Facilitation Charge);

- (e) the forfeiting of any right to relinquish Access Rights that may arise under this Undertaking; or
- (f) in respect of a Reference Train Service, Access Charges and all other monetary consideration (whether under an Access Agreement or another agreement) being calculated other than in accordance with the Reference Tariffs.

It is acknowledged that any conditions additional to that contained in the Standard Access Agreement which an Access Seeker (or an affected Access Holder) consider are material are deemed to be material for the purposes of this definition (and therefore are Access Conditions).

Subject to the foregoing, conditions that are immaterial and are therefore not Access Conditions include minor amendments to the terms of the Standard Access Agreement such as:

- (a) a minor variation to payment terms (for example, changing the time period for payment of an invoice to fit with an Access Holder's payment cycle); or
- (b) an amendment to insurance requirements to take account of a counterparty's existing insurance policies.

Access Conditions are subject to approval by the QCA in accordance with **clause 6.13.2** of this Undertaking and must not be inconsistent with the Act.

Access Facilitation Charge	An ongoing charge separate to an Access Charge for the facilitation of Access which is payable irrespective of the actual use of the Rail Infrastructure.
Access Holder	Unless expressed to the contrary, a person that has been granted Access Rights to operate Train Services on all or part of the Rail Infrastructure.
Access Provision Period	A Month or, where the period specified in the relevant Access Agreement in provisions relating to Claims and exclusions in respect of non-provision of Access Agreement is different, that different period.
Access Rights	An entitlement to Access in accordance with a specified Train Service Entitlement.
Access Seeker	Subject to clause 4.9(a) and unless expressed to the contrary, the entity that provides Aurizon Network with a properly completed Access Application, but does not include a request to enter into a Train Operations Deed.

Access Seeker Nomination	The meaning given to that term in clause 8.4.3(b)(i)(B)(2) .
Acknowledgement Notice	A notice given to an Access Seeker under clause 4.4(a) acknowledging the receipt of an Access Application.
Act	<i>Queensland Competition Authority Act 1997 (Qld)</i> .
Ad Hoc Train Service	A Train Service: <ul style="list-style-type: none"> (a) which is additional to the number of Train Services permitted to operate in a Month under a Train Service Entitlement for that Train Service but which is otherwise in accordance with the Train Service Entitlement under the relevant Access Agreement; or (b) where paragraph (a) does not apply, that varies from the Train Service Entitlement under the relevant Access Agreement but which Aurizon Network permits to operate.
Additional Information	The information required to be provided by Aurizon Network to an Access Seeker under clause 2 of Schedule A .
Adjusted Allowable Revenue	The amount described as such under clause 4.3(c) of Schedule F .
Adjustment Amount	The meaning given to that term in clause 6.1(a) of Schedule F .
Adjustment Charge	For a Billing Period, the amount calculated in accordance with clause 6.1 of Schedule F .
Adjustment Date	1 July 2017.
Affected Access Holder	An Access Holder whose Access Rights are affected by a Capacity Shortfall or Expansion Capacity Deficit (as applicable).
Affected Person	The meaning given to that term in clause 7A.7.4(c)(i) .
Allowable Revenue	In relation to a Reference Tariff for a Year, the amount described as such in accordance with clause 4.2 of Schedule F .
AN Performance Breach	<ul style="list-style-type: none"> (a) any breach by Aurizon Network of an obligation under the Undertaking or any Access Agreement; (b) Aurizon Network acting inconsistently with the Approved Maintenance Strategy and Budget, Approved Renewals Strategy and Budget or Approved Maintenance Approach other than where permitted by clause 7A.11.3(q); or

- (c) any failure by Aurizon Network (including by any Aurizon Network Personnel) to comply with a System Operating Parameter under its control,

except to the extent that any act or omission of Aurizon Network under **paragraphs (a) – (c)** is directly attributable to the proper performance, completion and/or implementation of any Transitional Arrangements agreed to or determined under **clause 07A.5**.

AN Performance Shortfall

- (a) In respect of the period between the Report Date and the implementation of any Transitional Arrangements to address any Existing Capacity Deficit, in respect of each origin and destination combination specified in an Access Holder's Access Agreement and for that period:
 - (i) the aggregate number of Train Service Entitlements for the relevant origin and destination combination for that period that the Independent Expert determines could have been utilised by the Access Holder having regard to the IE Initial Capacity Assessment and any other Access Holders affected by the Existing Capacity Deficit (if any); less
 - (ii) the number of Train Service Entitlements for the relevant origin and destination combination that the Independent Expert determines were utilised by the Access Holder during the relevant period.
- (b) For all Years following the implementation of the Transitional Arrangements, in respect of each origin and destination combination specified in an Access Holder's Access Agreement and each Relevant Year:
 - (i) the aggregate number of Train Service Entitlements specified in the relevant Access Agreement for the relevant origin and destination combination for the Relevant Year; less
 - (ii) the number of Train Service Entitlements for the relevant origin and destination combination that the Independent Expert determines were utilised by the Access Holder during the Relevant Year.

Ancillary Access Rights

The meaning given to that term in **clause 7.4.2(a)(iii)(C)**.

Ancillary Revenues	Charges for services that are ancillary to other services supplied under an Access Agreement (including, for example, repositioning, and license arrangements) to the extent that the QCA determines from time to time should be included in this definition.
Annual Capacity Assessment	The meaning given to that term in clause 7A.4.2 .
Annual Capacity Assessment Report	The meaning given to that term in clause 7A.4.2(d)(i) .
Applicable Undertaking	This Undertaking, the 2016 Undertaking, the 2010 Undertaking, the 2008 Undertaking, the 2005 Undertaking or the 2001 Undertaking that applied at the relevant time.
Approval Date	The date on which this Undertaking was approved by the QCA.
Approval Date of the 2016 Undertaking	11 October 2016.
Approved Capital Expenditure	All capital expenditure approved by the QCA in accordance with Schedule E .
Approved Derogation	In respect of any Rollingstock or Rollingstock Configuration which does not comply with the Rollingstock Interface Standards, a departure from the Rollingstock Interface Standards which the IRMP identifies can be effectively managed by complying with measures specified in the IRMP in respect of such Rollingstock or Rollingstock Configuration.
Approved Maintenance Approach	The meaning given to that term in clause 7A.11.1(a)(i)(B) .
Approved Maintenance Strategy and Budget	The meaning given to that term in clause 7A.11.3(l) 7.11.3(l) .
Approved PIC	The meaning given to that term in clause 6.3.2(a) .
Approved Renewals Strategy and Budget	The meaning given to that term in clause 7A.11.3(n).
Approved Undertaking	This Undertaking, the 2016 Undertaking, the 2010 Undertaking, the 2008 Undertaking, the 2005 Undertaking and the 2001 Undertaking.

Approved WACC	The post-tax nominal (vanilla) weighted average cost of capital calculated as follows: <ul style="list-style-type: none"> (a) from 1 July 2017 until the Initial Date, 5.7% p.a.; (b) from the Initial Date until the Report Date, 5.9% p.a.; (c) from the Report Date (where occurring prior to the Reset Date), 6.3% p.a.; (d) from the Reset Date until the Terminating Date, the Reset WACC.
Assessor	The meaning given to that term in clause 10.4.3(b) .
Asset Management Plan	The asset management plan accepted by the QCA under clause 3 of Schedule E , as amended from time to time.
Asset Replacement and Renewal	Capital projects required to maintain the Existing Capacity of the Rail Infrastructure including: <ul style="list-style-type: none"> (a) the replacement of life expired or obsolete assets; and (b) the replacement of assets which are lost, damaged or destroyed as a result of a Force Majeure Event, and which are required for Aurizon Network to meet its existing contractual obligations under Access Agreements.
Asset Replacement and Renewal Expenditure	Expenditure on Asset Replacement and Renewal.
AT₁	The meaning given in clause 2.2 of Schedule F .
AT₂	The meaning given in clause 2.2 of Schedule F .
AT₂₋₄	The aggregate of the AT ₂ , AT ₃ and AT ₄ components of Access Charges.
AT₂₋₄ Revenue Adjustment Amount	For a Coal System, the amount calculated under clause 4.3(a) of Schedule F for that Coal System.
AT₃	The meaning given in clause 2.2 of Schedule F .
AT₄	The meaning given in clause 2.2 of Schedule F .
AT₅	The meaning given in clause 2.2 of Schedule F .
AT₅ Revenue Adjustment Amount	For a Coal System, the amount calculated under clause 4.3(b) of Schedule F for that Coal System.

AT₅ Revenue Shortfall	For a Year, where the Total Actual Revenue for AT ₅ (calculated under clause 4.3(j) of Schedule F) in relation to that System Reference Tariff for that Year is less than the Adjusted Allowable Revenue for AT ₅ (calculated under clause 4.3(c) of Schedule F) for the relevant System Reference Tariff for that Year.
AT₅ Revenue Shortfall Amount	For a Year, where there is an AT ₅ Revenue Shortfall, the amount by which Total Actual Revenue for AT ₅ (calculated under clause 4.3(j) of Schedule F) in relation to the relevant System Reference Tariff for that Year is less than the Adjusted Allowable Revenue for AT ₅ (calculated under clause 4.3(c) of Schedule F) for the relevant System Reference Tariff for that Year.
Audit Majority of End Users	In respect of End Users with Access Rights in any Coal System (Voting End Users), a number of Voting End Users that in aggregate hold at least 35% of the End User Voting Rights (Network) held by the Voting End Users for the Year.
Auditor	An auditor appointed under clause 10.6.4(c) 10.6.4(a) and compliant with the requirements of that clause 10.6.4(c) .
Aurizon Entity	For the purposes of Part 3 refers to: <ul style="list-style-type: none"> (a) each company in the Aurizon Group; and (b) each Related Party of Aurizon Network.
Aurizon Group	The group of companies for which the holding company (as defined under the Corporations Act) is the Ultimate Holding Company.
Aurizon Holdings	Aurizon Holdings Limited ACN 146 335 622.
Aurizon Network	Aurizon Network Pty Ltd ACN 132 181 116.
Aurizon Network Cause	Where Aurizon Network is unable to make Rail Infrastructure available for the operation of Train Services in accordance with any Access Holder's Train Service Entitlement, as a result of: <ul style="list-style-type: none"> (a) Planned Possessions, Emergency Possessions or Urgent Possessions; (b) a Force Majeure Event; or (c) any other action by Aurizon Network which directly resulted in the Rail Infrastructure not being so available, <p>where such inability by Aurizon Network is not attributable:</p>

- (d) to the Access Holder (or its nominated Train Operator);
- (e) to Aurizon Network complying with its Passenger Priority Obligations;
- (f) to the unavailability of the relevant Access Holder's loading facility or an unloading facility;
- (g) to the failure to load a Train at the relevant Access Holder's loading facility within the maximum time at loading facility (as specified in the relevant Access Agreement) for that Train Service, or unload a Train at the relevant Access Holder's unloading facility within the maximum time at unloading facility (as specified in the relevant Access Agreement) for that Train Service; or
- (h) in respect of a Train Service that will operate on Private Infrastructure prior to entering and/or after exiting the Rail Infrastructure as part of its journey, to the unavailability of, or cancellation of train services on, that Private Infrastructure.

Aurizon Network Personnel

The:

- (a) directors and officers of Aurizon Network; and
- (b) employees, contractors and agents of Aurizon Network and any other person under the control or supervision of Aurizon Network (including secondees working in the business of Aurizon Network).

Aurizon Network's Executive Officer

The person who is, from time to time, the chief executive of Aurizon Network.

Aurizon Party

A Related Party of Aurizon Network other than a Related Party of Aurizon Network who is a User Funding Trustee.

Authority

The Crown (in right of the State or the Commonwealth), a minister of the Crown, a federal, state or local government department, a corporation or authority constituted for a public purpose, a holder of an office for a public purpose, a local authority, a court, a tribunal and any officer or agent of the foregoing acting as such.

Available Capacity

Capacity, excluding all Committed Capacity.

Average Annual Payload

The meaning given to that term in the Standard Access Agreement.

Baseline Capacity Assessment

The Capacity assessment undertaken by Aurizon Network under the 2016 Undertaking in accordance with **clause 7A.4.1** of the 2016 Undertaking.

Below Rail Delay	<p>A delay to a Train Service from its scheduled Train Path in the DTP, where that delay can be attributed directly to Aurizon Network, but excludes:</p> <ul style="list-style-type: none"> (a) cancellations; (b) delays resulting from compliance with a Passenger Priority Obligation; and (c) delays resulting from a Force Majeure Event.
Below Rail Services	<p>The activities required to supply the declared services contemplated by section 250(1)(a) of the Act, including those activities associated with the provision and management of Rail Infrastructure and Access and which include the construction, maintenance and renewal of Rail Infrastructure assets, and the network management services required for the safe operation of Train Services on the Rail Infrastructure, including Network Control Services and the implementation of Safeworking Procedures and Below Rail has a similar meaning.</p>
Below Rail Transit Time	<p>For a Train Service travelling between its origin and destination, the sum of:</p> <ul style="list-style-type: none"> (a) the relevant nominated section running times (in the direction of travel) as specified in the Train Service Entitlement; (b) identified Below Rail Delays for that Train Service; (c) the time taken in crossing other Trains to the extent that such time is not contributed to by Above Rail causes or Force Majeure Events or otherwise included in paragraph (a) of this definition; and (d) delays due to Operational Constraints directly caused by the activities of Aurizon Network in maintaining the Rail Infrastructure, provided such delays are not contributed to by Above Rail causes or Force Majeure Events or otherwise included in paragraphs (b) and (c) of this definition.
Below Rail Transit Time Percentage	<p>For a type of Train Service specified in a Train Service Entitlement, the proportion (expressed as a percentage) calculated by dividing the Below Rail Transit Time by the maximum sectional running times (as set out in the relevant Access Agreement) for all relevant sections (as set out in the relevant Access Agreement).</p>

Billing Period	The meaning given to that term in the relevant Access Agreement.
Blackwater System	The Rail Infrastructure comprising the rail corridor from the port of Gladstone (including domestic coal terminals in the vicinity of Gladstone) to Gregory, Minerva and Rolleston mines, and all branch lines directly connecting coal mine loading facilities to those corridors with the exception of the corridor to Oaky Creek (and beyond) and the corridor to Moura mine (and beyond).
Business Day	A day which is not a Saturday, Sunday or special or public holiday in Brisbane or, if and to the extent that this Undertaking expressly refers to another place, in that other place.
Capacity	The aggregate of Existing Capacity and Planned Capacity.
Capacity Analysis	<p>(a) For the period prior to the Initial Capacity Assessment Report being published by the QCA on its website as contemplated by clause 7A.4.1(h), a simulation modelling assessment of the Available Capacity of the Rail Infrastructure, based on the Network Management Principles, System Operating Parameters, System Rules, Train Operator's Operating Plans and any requested Access Seeker's Access Rights, to determine, as the context requires:</p> <ul style="list-style-type: none"> (i) Available Capacity; (ii) whether there is sufficient Capacity to accommodate Committed Capacity; (iii) whether there is sufficient Available Capacity to accommodate the requested Access Rights not yet considered to be Committed Capacity; (iv) if there is insufficient Capacity to accommodate Committed Capacity, the Expansions required to provide the Shortfall Capacity to accommodate Committed Capacity (and an indicative estimate of the cost of such works and timing for completion); (v) if there is insufficient Available Capacity to accommodate requested Access Rights not yet considered to be Committed Capacity, whether Expansions are required to provide the additional Capacity to accommodate the requested Access Rights (and an indicative estimate of the cost of such works and timing for completion); and

- (vi) the operational impacts of the requested Access Rights including the impact of the requested Access Rights on the, Network Management Principles, System Operating Parameters, System Rules and Train Operator's Operating Plans,

and which:

- (vii) provides a sufficient basis to enable Aurizon Network to finalise the relevant Train Service Entitlement, initial timetable, applicable Access Charges and associated funding arrangements (subject to other variations identified in the negotiation process); and
- (viii) for information purposes only:
 - (A) includes the Monthly available tonnes based on Nominal Train Payloads outlined in **Schedule F**; and
 - (B) identifies the assumed split of traffic to different destinations serviced by the relevant Coal System; and

(b) thereafter, a Deliverable Network Capacity Analysis.

Capacity Assessment

- (a) For the period prior to the Initial Capacity Assessment Report being published by the QCA on its website as contemplated by **clause 7A.4.1(h)**, the most recent capacity assessment undertaken by Aurizon Network; and
- (b) thereafter, the IE Initial Capacity Assessment or Annual Capacity Assessment, as the context requires.

Capacity Assessment Notice

The meaning given to that term in **clause 8.9.5(b)(i)**.

Capacity Assessment Period

The period to which each Capacity Assessment relates, being:

- (a) in respect of the IE Initial Capacity Assessment, commences on 1 July 2019;
- (b) in respect of each Annual Capacity Assessment, commences on 1 July of each subsequent year; and
- (c) in respect of any other assessment of Deliverable Network Capacity, commences on the most

appropriate date as determined by the Independent Expert,

and which ends on 30 June of the year in which the later of the following occurs or is expected to occur as determined by the Independent Expert:

- (d) five (5) years after the commencement of the IE Initial Capacity Assessment, Annual Capacity Assessment or other assessment (as applicable);
- (e) the peak point for contracted Access under existing Access Agreements and Access Applications (and assuming Renewals occur in respect of the Access Rights under those Access Agreements and Access Applications); and
- (f) the completion and commissioning of any Expansion that Aurizon Network is obliged to construct (other than as a result of a Deliverable Network Capacity Shortfall).

Capacity Change

The change in:

- (a) prior to the Initial Capacity Assessment Report being published by the QCA on its website as contemplated by **clause 7A.4.1(h)**, Capacity arising as a result of that Expansion after the Expansion is commissioned by calculating:
 - (i) the Existing Capacity at the time; less
 - (ii) the Existing Capacity of the system in the absence of the Expansion,using consistent System Operating Parameters; and
- (b) thereafter, Deliverable Network Capacity arising as a result of that Expansion by calculating the:
 - (i) the Deliverable Network Capacity of the Coal System at the time the assessment is undertaken; less
 - (ii) the Deliverable Network Capacity of the Coal System in the absence of the Expansion,using consistent System Operating Parameters.

**Capacity
Expenditure
Allowable
Revenue
Adjustment**

The meaning given to that term in clause **5(b)** of **Schedule E**.

Capacity Information	The information required to be provided by Aurizon Network to an Access Seeker under clause 3 of Schedule A .
Capacity Notification Register	The register maintained by Aurizon Network under clause 7.2.2 .
Capacity Shortfall	<p>For the period prior to the Initial Capacity Assessment Report being published by the QCA on its website as contemplated by clause 7A.4.1(h), a circumstance where the Capacity is:</p> <ul style="list-style-type: none"> (a) less than the Committed Capacity of the relevant Coal System, Track Segment, Segment or other part of the Rail Infrastructure, as the context requires; or (b) less than the Committed Capacity of an Expansion where the Access Rights are conditional on that Expansion being completed and commissioned.
Capital Carryover	Includes adjustments to be recovered over the period 1 July 2017 to 30 June 2021 which relate to revenue differences derived from approved capital expenditure against the Capital Indicator included in the 2016 Access Undertaking as described in Section 3.2 of the QCA's 2018 Decision.
Capital Indicator	The annual capital expenditure allowance approved by the QCA, from time to time, for the purpose of assessing the relevant Reference Tariffs.
CDMP	The meaning given to that term in clause 1.2 of Schedule J .
Central Queensland Coal Network	<p>the rail corridors:</p> <ul style="list-style-type: none"> (a) from the ports at Hay Point and Dalrymple Bay to Blair Athol mine, North Goonyella mine, Hail Creek mine and the junction with the Gladstone to Gregory mine corridor; (b) from the port of Gladstone (including domestic coal terminals in the vicinity of Gladstone and including, but not limited to, the Wiggins Island Coal Export Terminal) to Gregory, Minerva and Rolleston mines; (c) from the port of Gladstone (including domestic coal terminals in the vicinity of Gladstone) to Moura mine and the loading facility for Baralaba mine in the vicinity of Moura mine; (d) from the port of Abbot Point to North Goonyella mine; and

	(e) all branch lines directly connecting coal mine loading facilities to the abovementioned corridors.
Chair of the Rail Industry Group	Such person as may appointed as the chair of the Rail Industry Group from time to time and advised to Aurizon Network and the QCA in writing.
Change in Law	Any of the following: <ul style="list-style-type: none"> (a) any amendment, repeal or enactment of any Law; (b) any change in the interpretation or application, including by the exercise of delegated authority, of any Law resulting from a decision of a court or Authority; (c) the making of any new directive, or any change in an existing directive, of any Authority; (d) the imposition of a requirement for authorisations not required as at the Commencing Date; (e) after the date of grant of any authorisation, a change in the terms and conditions attaching to that authorisation or the attachment of any new terms or conditions; or (f) any such authorisation as has been granted ceasing to remain in full force and effect or, if granted for a limited period, not being renewed on a timely basis on application therefore being duly made, or being renewed on conditions which are materially less favourable than those attached to the original authorisation.
Change in Relevant Taxes	Any of the following: <ul style="list-style-type: none"> (a) the imposition of a new Relevant Tax; (b) an increase in the rate of a Relevant Tax; or (c) a change in the basis of calculation of a Relevant Tax.
Changes in Market Circumstances	Changes in circumstances which have occurred in any market and which have had, or will have, a material effect on an Access Holder's ability to pay the Access Charges.
Claim	Any action, proceeding, claim, demand, damage, loss, cost, liability or expense, including the costs and expenses of defending or settling any action, proceeding, claim or demand.

Coal Loss Mitigation Provisions	The provisions set out in Schedule J .
Coal System	Any one of the following: <ul style="list-style-type: none"> (a) the Newlands System; (b) the Goonyella System; (c) the Blackwater System; (d) the Moura System; or (e) the Goonyella to Abbot Point System.
Commencing Date	1 July 2017.
Committed Capacity	That portion of the Capacity that is required: <ul style="list-style-type: none"> (a) to meet Train Service Entitlements; (b) to satisfy Aurizon Network's obligations under clause 7.3(d) in respect of a Renewing Access Seeker; (c) to comply with any Passenger Priority Obligation or Preserved Train Path Obligation; (d) to provide Access Rights where Aurizon Network has, in relation to those Access Rights, contractually committed to construct an Expansion; and (e) to provide Access Rights where Aurizon Network has, in relation to those Access Rights, contractually committed to construct a Customer Specific Branch Line.
Committed Capacity Register	The register maintained by Aurizon Network under clause 7.2.3 .
Committed Expansion Funding Amount	An amount of \$30 million or, where applicable, the amount deemed to be the 'Committed Expansion Funding Amount' under clause 8.2.1(b)(ii)(B)(1) .
Common Corridor	That part of the Rail Infrastructure that: <ul style="list-style-type: none"> (a) either: <ul style="list-style-type: none"> (i) would be utilised by a Railway Operator to operate Train Services for the Access Holder utilising the Nominated Access Rights; or (ii) if the Access Holder has not nominated a Railway Operator to operate Train Services utilising the Nominated Access Rights, would have been utilised by a Railway Operator had the Access Holder nominated a Railway

	Operator to operate the relevant Train Services; and
	(b) will also be utilised by the Transferee's Train Services.
Common Costs	Those costs associated with provision of Rail Infrastructure that are not Incremental Costs for any particular Train Service using that Rail Infrastructure.
Comparative Length	In respect of a Train, the length of that Train calculated as: <ul style="list-style-type: none"> (a) the Static Length of that Train multiplied by 1.02; plus (b) 125mm multiplied the number of items of Rollingstock comprising or to comprise that Train (including the locomotive/s).¹
Competing Applications	The Access Applications of two or more Access Seekers that are seeking Access Rights relating to the same traffic task and are either: <ul style="list-style-type: none"> (a) the Access Applications of two or more Access Seekers who are competing in order to provide Train Services under a rail haulage agreement with the same Customer for the same Train Services; or (b) the Access Applications of an Access Seeker who is seeking Access Rights in order to provide Train Services under a rail haulage agreement with a Customer and the Access Application of that Customer for the same Train Services.
Competitive Funding Process	The meaning given to that term under clause 8.7.1(e)(ii)(A) .
Complainant	The meaning given to that term in clause 3.21(a) .
Completion Date	The meaning given to that term in clause 8.6(a)(i)(C) .
Compliance Officer	The Aurizon Network employee designated as such by the Aurizon Network's Executive Officer.
Concept Study	A study that enables a preliminary assessment of the potential costs, benefits and risk involved in providing the capacity required in respect of a potential Expansion and includes:

¹ By way of explanation, this comparative Train length comprises the following: static Train length (which is the straight addition of individual Rollingstock lengths) plus an allowance of 2% of this static Train length for train handling accuracy plus 125mm per vehicle for slack movement in drawgear (includes free slack in the drag box, compression of the draftgear, clearance/free slack due to coupler wear and pin clearance at the yoke).

- (a) identification of a possible technical solution to provide the capacity required for the potential Expansion;
- (b) unless otherwise agreed by Aurizon Network and an Access Seeker, includes an indicative assessment of:
 - (i) project objectives;
 - (ii) a broad cost estimate of the potential solution with a +/-50% accuracy;
 - (iii) preliminary financial analysis;
 - (iv) preliminary risk assessment; and
 - (v) indicative timeframes for the development and delivery of the project;
- (c) a Pre-feasibility Study execution plan, including a proposed scope of work (taking into account the scope of work required by the definition of “Pre-feasibility Study” in this Undertaking), budget, time schedule and deliverables; and
- (d) a written report on the outcome of the analysis and the reasons for the selection(s) made and the preliminary scope, cost and program details of the selected alternatives.

Condition Based Assessment

The meaning given to that term in **clause 10.4.3(a)**.

Conditional Access Holders

The meaning given to that term in **clause 8.9.2(a)**.

Conditional Access Rights

The meaning given to that term in **clause 8.9.2(a)**.

Confidential Information

- (a) Subject to paragraphs (b) and (c) of this definition, any information, data or other matter (“**information**”) disclosed to a party by, or on behalf of, another party where:
 - (i) the disclosure of the information by the recipient might reasonably be expected to affect the commercial affairs of the owner of the information; or
 - (ii) the information is marked confidential by a party when disclosed,
provided that such information:
 - (iii) is not already in the public domain;

- (iv) does not become available to the public through means other than a breach of the confidentiality provision in this Undertaking or any confidentiality deed contemplated in **clause 3.11(a)(vi)**;
- (v) was not in the other party's lawful possession prior to such disclosure; and
- (vi) is not received by the other party independently from a third party free to disclose such information, data or other matter,

and provided further that information will cease to be Confidential Information if the information has ceased to retain its confidential nature, for example:

- (vii) the information is now in the public domain through means other than a breach of the confidentiality provisions in this Undertaking or any confidentiality deed contemplated in **clause 3.11(a)(vi)**; or
- (viii) the information has been received by the recipient independently from a third party free to disclose the information.

- (b) If a document or discussion is comprised of information only some of which would be Confidential Information as a result of **paragraph (a)** of this definition, the remainder of the information in the document or discussion is not Confidential Information to the extent that Aurizon Network can clearly separate the remainder of the information from the Confidential Information.
- (c) Information which relates to matters other than in respect of the declared services contemplated by section 250(1)(a) of the Act is not Confidential Information for the purposes of disclosure by Aurizon Network to a Related Operator or a Related Competitor.

Confidential Information Register

The register established and maintained under **clause 3.14**.

Connecting Infrastructure

The rail transport infrastructure (including track, signalling and overhead electric traction (if applicable)) which connects the Private Infrastructure to the Rail Infrastructure and that on completion forms part of the Rail Infrastructure and, where Connecting Infrastructure is the subject of a

	Rail Connection Agreement, is more particularly defined in the relevant Rail Connection Agreement.
Connection Milestone	The meaning given to that term in clause 9.1(e) .
Construction Agreement	The meaning given to that term in the Standard Rail Connection Agreement.
Contested Train Path	A Train Path in respect of which more than one Access Holder has expressed an interest in operating a Train Service in the week in question.
Corporations Act	The <i>Corporations Act 2001</i> (Cth) and the regulations made under it, as amended from time to time.
Costing Manual	The cost allocation manual either: <ul style="list-style-type: none"> (a) prepared by Aurizon Network and approved by the QCA; or (b) prepared by the QCA under section 159(1) of the Act, as revised by the QCA from time to time under sections 159(2) and (3) of the Act.
CPI	The Consumer Price Index: All Groups – Brisbane (Australian Bureau of Statistics Publication No.6401.0, Tables 1 and 2, Series ID: A2325816R).
CPI Forecast	<ul style="list-style-type: none"> (a) from 1 July 2017 until the Reset Date, 2.37%; and (b) from the Reset Date until the Terminating Date, the Reset Inflation Rate.
Cross Subsidy	<p>Where the Access Charges payable in respect of one Train Service or combination of Train Services are insufficient to meet:</p> <ul style="list-style-type: none"> (a) the Incremental Cost imposed on the Rail Infrastructure by that Train Service or combination of Train Services; and (b) in respect of a combination of Train Services, the Common Costs related specifically to sections of Rail Infrastructure that are used solely for the purpose of Train Services within that combination of Train Services, <p>and the shortfall is contributed to by another Train Service or combination of Train Services.</p>
Cross System Train Service	A coal carrying Train Service that requires Access in respect of more than one Coal System (excluding any Train Service that operates solely within the Goonyella to Abbot Point System even though it might otherwise require

	Access to more than one Coal System – for example, the Goonyella System and the Newlands System).
Customer	A person in respect of which an Access Holder or an Access Seeker is or is intending to use Access Rights to provide Train Services for that person (in that Access Seeker's or Access Holder's capacity as a Railway Operator).
Customer Access Seeker	<p>(a) Where:</p> <p>(i) two or more Access Seekers have submitted Access Applications for the same Access Rights; and</p> <p>(ii) one of those Access Seekers (Principal Access Seeker) is the Customer for one of the other Access Seekers, the Principal Access Seeker; or</p> <p>(b) in all other cases, an Access Seeker who is not and will not be the Train Operator in relation to the Access Rights sought.</p>
Customer Initiated Transfer	The meaning given to that term in clause 7.4.7(a).
Customer Nomination	The meaning given to that term under clause 8.4.3(b)(i)(B)(1).
Customer Specific Branch Line	<p>An extension, enhancement, expansion, augmentation, duplication or replacement of all or part of the Rail Infrastructure:</p> <p>(a) to be constructed solely to connect an Access Holder's or a Customer's loading facility to Rail Infrastructure; and</p> <p>(b) that on completion will form part of the Rail Infrastructure,</p> <p>excluding:</p> <p>(c) Connecting Infrastructure; and</p> <p>any capital expenditure project to the extent that it involves Asset Replacement and Renewal Expenditure.</p>
Cyclic Traffic	A traffic, the Train Service Entitlements in respect of which are defined in terms of a number of Train Services within a particular period of time, for example, a year, Month, week or day. Coal traffic is an example of such traffic.
Daily Train Plan or DTP	The meaning given to that term in clause 5.1 of Schedule G .

Debt Risk Premium	The premium for risk above the risk-free rate associated with debt financing as referred to in the 'Cost of debt' section of Appendix F of the QCA's 2018 Decision.
Decision	The meaning given to that term in clause 11.2(a) .
Decline in Electric Utilisation	<p>For a Year:</p> <p>(a) where the Electric Utilisation Level is less than the Electric Utilisation Floor for the relevant System Reference Tariff for that Year; and</p> <p>(b) where the aggregate actual egtk for that Year in the Coal System to which the relevant System Reference Tariff applies is less than the total resulting from the multiplication of A and B and C where:</p> <p style="margin-left: 40px;">A = the GtK Forecast for that Year in the relevant Coal System;</p> <p style="margin-left: 40px;">B = the Electric Capacity Factor for the relevant Coal System; and</p> <p style="margin-left: 40px;">C = the Electric Utilisation Floor for the relevant Coal System.</p>
Deliverable Network Capacity	The meaning given to that term in clause 7A.2(a) .
Deliverable Network Capacity Analysis	<p>A simulation modelling assessment with respect to the Capacity Assessment Period::</p> <p>(a) the Deliverable Network Capacity;</p> <p>(b) the extent to which the Deliverable Network Capacity can deliver the Committed Capacity;</p> <p>(c) the Deliverable Network Capacity Shortfall (if any);</p> <p>(d) whether there is sufficient Available Capacity to accommodate the requested Access Rights not yet considered to be Committed Capacity;</p> <p>(e) if there is a Deliverable Network Capacity Shortfall, the Expansions required to provide the Capacity to accommodate Committed Capacity; and</p> <p>(f) if there is insufficient Available Capacity to accommodate requested Access Rights not yet considered to be Committed Capacity, whether Expansions are required to provide the additional Capacity to accommodate the requested Access Rights,</p>

	at the time the assessment is undertaken.
Deliverable Network Capacity Shortfall	A circumstance where the Deliverable Network Capacity of a Coal System within the relevant Capacity Assessment Period is less than the number of Train Paths required to meet Train Service Entitlements (without regard to exclusions in Access Agreements for the non provision of Train Service Entitlements).
Demand Assessment	An estimation (acting reasonably) of: <ul style="list-style-type: none"> (a) the demand for Capacity beyond Available Capacity and Committed Capacity; and (b) the estimated time for which the Capacity referred to in paragraph (a) is required, having regard to the relevant information in accordance with clause 8.2.4(b) .
Depreciated Optimised Replacement Cost or DORC	The value of assets determined in the following manner: <ul style="list-style-type: none"> (a) the replacement value of the assets will be assessed as the cost of the modern engineering equivalent replacement asset; (b) optimisation of the asset base will occur, but such optimisation will only consider whether or not the infrastructure standard and infrastructure capacity are excessive, given the current and likely future requirements of Access Holders; and (c) depreciation of the optimised replacement asset value will be undertaken over the useful life of the assets.
Destination System	<ul style="list-style-type: none"> (a) For any Train Service which originates in the Blackwater System and uses the Goonyella Newlands Connection, the Goonyella to Abbot Point System; or (b) in all other cases, the Coal System on which the Nominated Unloading Facility is located.
Destination Tariff	The relevant Reference Tariff applying to the relevant Cross System Train Service in the Destination System.
Direct Maintenance Costs	The costs relating to the maintenance activities as described in Section 8.5.1 of the QCA's 2018 Decision.
Discount Rate	The rate equivalent to the ROA, as defined in clause 6.6.3(c) .
Dispute	The meaning given to that term in clause 11.1.1(a) .

Dispute Notice	A notice given under clause 11.1.1 specifying the nature of the Dispute and the proposed resolution.
Distribution Entities	The meaning given to that term in the <i>Electricity Act 1994</i> (Qld).
Draft System Rules	The meaning given to that term in clause 7A.7.3(b) .
DTMR	The Department of Transport and Main Roads for the State of Queensland or other department from time to time responsible for the administration of the TIA.
Dwell	Where a Train stops for a short period on Rail Infrastructure at locations specified by Aurizon Network as required for crew changes, meal breaks and maintenance, examination and provisioning of that Train.
Earlier Expansion Agreements	The meaning given to that term under clause 8.2.3(a)(v)(A) .
EC	The electric energy charge defined as “EC” in clause 2.2(a) of Schedule F .
Efficient Cost	The cost for each Year during the Evaluation Period, that reflects the cost that would be reasonably expected to be incurred by a Railway Manager adopting efficient work practices in the provision of the Rail Infrastructure to the required service standard, having regard to any matters particular to the environment in which Aurizon Network operates, and including any transitional arrangements agreed between Aurizon Network and the QCA to reflect the transition from Aurizon Network’s actual cost to that efficient cost.
egtk	<p>The electric gross tonne kilometres attributed to the relevant Train Service, being:</p> <ul style="list-style-type: none"> (a) the gtk for the Train Service, if that Train Service uses electric traction; and (b) zero, if the Train Service does not use electric traction.
Electric Capacity Factor	<p>The maximum capability of the electric traction on the Rail Infrastructure, expressed as a percentage of the average annual forecast gtk for the relevant regulatory period, being:</p> <ul style="list-style-type: none"> (c) 98% in Goonyella; and (d) 94% in Blackwater, <p>or such other percentage as may be approved from time to time by the QCA.</p>

Electric Operating Expenditure Allowance	An allowance to compensate Aurizon Network for those costs outlined within Section 7.8 of the QCA's 2018 Decision.
Electric Revenue Adjustment	The amount calculated under clause 4.3(l) of Schedule F .
Electric Utilisation Floor	<p>(e) For the System Reference Tariff applicable in the Goonyella System, 71% (being the fixed percentage threshold of the gtk in the Goonyella System using electric traction for the purposes of the Electric Revenue Adjustment); and</p> <p>(f) For the System Reference Tariff applicable in the Blackwater System, 65% (being the fixed percentage threshold of the gtk in the Blackwater System using electric traction for the purposes of the Electric Revenue Adjustment).</p>
Electric Utilisation Level	For a Year, the aggregate actual egtk for that Year in the Coal System to which the relevant System Reference Tariff applies as a percentage of the aggregate actual gtk for that Year in that Coal System.
Emergency Possession	A Possession required to rectify a serious fault with the Rail Infrastructure that Aurizon Network (acting reasonably) considers dangerous to any person, or where severe speed restrictions have been imposed affecting the scheduled Train Services of Railway Operators and that Aurizon Network, complying with the Possession Protocols, will use reasonable endeavours to carry out within seven days after the detection of the fault giving rise to the need for that Possession.
Emergency Response Plan	The meaning given to that term in clause 15.1(a)(i)(B) of the Standard Train Operations Deed.
End User	<p>(a) Each Access Holder (other than an Access Holder that holds Access Rights for the purpose of providing Train Services for a Customer); and</p> <p>(b) each Customer.</p>
End User DAAU	The meaning given to that term under clause 12.6(a)(iv) .
End User Voting Rights (Coal System)	<p>The voting rights in respect of an End User with Access Rights in the relevant Coal System for a Year determined by the Independent Expert on an annual basis in accordance with the following formula:</p> <p>EUVR (Coal System) = MCT/AMCT</p> <p>Where:</p>

EUVR (Coal System) means the End User's Voting Rights (Coal System) for the Year

MCT means the highest volume of the End User's Access Rights in the Coal System (expressed on a contracted tonnage basis) under existing Access Agreements:

- (a) assuming Renewals occur in respect of the Access Rights under those Access Agreements;
- (b) excluding any Access Rights that are conditional on the construction of a Customer Specific Branch Line or an Expansion;
- (c) excluding any Access Rights in respect of the Origin System for a Cross System Train Service; and
- (d) including any Access Rights in respect of the Destination System for a Cross System Train Service,

in any Year during the 5 Year Forecast Period; and

AMCT means the aggregate of the MCT for all End Users with Access Rights in the Coal System (expressed on a contracted tonnage basis),

provided that neither an Access Seeker nor a person in respect of which an Access Seeker is intending to use Access Rights holds any End User Voting Rights (Coal System) in respect of the Access Rights that are the subject of the relevant Access Application.

End User Voting Rights (Network)

The voting rights in respect of an End User for a Year determined by the Independent Expert on an annual basis in accordance with the following formula:

$$\mathbf{EUVR (Network) = MCT/AMCT}$$

Where:

EUVR (Network) means the End User's Voting Rights (Network) for the Year

MCT means the highest volume of the End User's Access Rights across all Coal Systems (expressed on a contracted tonnage basis) under existing Access Agreements:

- (a) assuming Renewals occur in respect of the Access Rights under those Access Agreements;
- (b) excluding any Access Rights that are conditional on the construction of a Customer Specific Branch Line or an Expansion;

- (c) excluding any Access Rights in respect of the Origin System for a Cross System Train Service; and
- (d) including any Access Rights in respect of the Destination System for a Cross System Train Service,

in any Year during the 5 Year Forecast Period; and

AMCT means the aggregate of the MCT for all End Users (expressed on a contracted tonnage basis),

provided that neither an Access Seeker nor a person in respect of which an Access Seeker is intending to use Access Rights holds any End User Voting Rights (Network) in respect of the Access Rights that are the subject of the relevant Access Application.

Endorsed Variation Event

The occurrence of any of the events listed in **clause 5.2 of Schedule F**.

Environment Compliance Charge

A charge determined by Aurizon Network equal to the aggregate of any fine, penalty, cost, impost or other amount incurred by, or imposed on, Aurizon Network by an Authority under any Environmental Law (including the EP Act) in relation to any non-compliance with the CDMP:

- (a) as a result of or in connection with any act or omission of the Access Holder (excluding good faith acts and omissions in accordance with an express request by Aurizon Network in relation to compliance); or
- (b) where the Access Holder fails to do, or not do, anything requested by Aurizon Network that would have avoided or reduced the amount incurred by, or imposed on, Aurizon Network.

Environmental Authorities

- (a) A “development approval” or “registration certificate” for a chapter 4 activity or an “environmental authority”, as those terms are defined under the EP Act; or
- (b) any approval (however described) which is deemed by the EP Act to be a “development approval”, “registration certificate” or “environmental authority” referred to in **paragraph (a)** of this definition.

Environmental Harm

Serious environmental harm, material environmental harm or environmental nuisance as those terms are defined in the EP Act.

Environmental Laws	<p>A Law relating to the environment (as defined under the EP Act), including:</p> <ul style="list-style-type: none"> (a) a Law relating to planning, health, toxic or contaminating materials, dangerous goods, waste disposal or pollution; and (b) environmental protection policies, guidelines, regulations and relevant approved codes of practice, and the conditions of all licences, notices, directions, approvals, consents, permissions or permits, issued under any such Law.
Environmental Management Plan	The meaning given to that term in clause 15.1(h) of the Standard Train Operations Deed.
Environmental Risks	All risks to the environment (as defined under the EP Act) arising or potentially arising from the Access Seeker's or Access Holder's proposed operations (including risks associated with the matters identified in clause 2.2 of Schedule C).
EP Act	Environmental Protection Act 1994 (Qld).
Equity Raising Costs	An allowance to compensate Aurizon Network for any equity raising costs for Approved Capital Expenditure as contemplated by clause 1.4 of Schedule E .
Evaluation Period	<ul style="list-style-type: none"> (a) When in reference to an individual Train Service, the period which is equal to the length of the expected duration of the existing or proposed Access Right under the Access Agreement in respect of the relevant Train Service; (b) when in reference to a combination of Train Services for the purpose of determining a Reference Tariff to apply for some or all of those Train Services, the period for which that Reference Tariff will apply; or (c) when in reference to a combination of Train Services other than referred to in paragraph (b) of this definition, the period which is equal to the length of the expected duration of the longest existing or proposed Access Right under an Access Agreement in respect of any of the Train Services comprising the combination of Train Services, provided that such period does not exceed 10 years.
Existing Capacity	<ul style="list-style-type: none"> (a) For the period prior to the Initial Capacity Assessment Report being published by the QCA on its website as contemplated by clause 7A.4.1(h), Absolute Capacity, net of:

	<ul style="list-style-type: none"> (i) Aurizon Network’s reasonable requirements for the exclusive or partial utilisation of the Rail Infrastructure for the purposes of performing activities associated with the maintenance and repair of the Rail Infrastructure, including the operation of work Trains; and (ii) Aurizon Network’s allowances for “day of operations” losses, speed restrictions and other operational losses or restrictions applicable to the Rail Infrastructure as set out in the System Operating Parameters; and
	(b) thereafter, Deliverable Network Capacity determined by the Independent Expert.
Existing Capacity Deficit	The meaning given to that term in clause 7A.5(a) .
Expanding User Expansion	<p>The meaning given to that term in clause 6.4.1(a).</p> <p>An extension, enhancement, expansion, augmentation, duplication or replacement of all or part of the Rail Infrastructure that on completion forms part of the Rail Infrastructure, excluding:</p> <ul style="list-style-type: none"> (a) Customer Specific Branch Lines; (b) Connecting Infrastructure; (c) Asset Replacement and Renewal; and (d) any extension, enhancement, expansion, augmentation, duplication or replacement of all or part of the Rail Infrastructure which is delivered as part of a project the primary objective of which is the improvement of operational safety; (e) any extension, enhancement, expansion, augmentation, duplication or replacement of all or part of the Rail Infrastructure that is delivered as part of a project the primary objective of which is the improvement of operational performance and that project (Operational Performance Project): <ul style="list-style-type: none"> (i) has a de minimus impact on capacity; and (ii) involves a total capital expenditure of either: <ul style="list-style-type: none"> (A) in respect of a single Operational Performance Project, under \$10 million; or (B) where there has been more than one Operational Performance Project within

the same Coal System within a Year, the cumulative total capital expenditure of all Operational Performance Projects within that Coal System within that Year is under \$20 million; or

- (iii) has otherwise been approved by the QCA in writing as a project which is not an Expansion for the purposes of this Undertaking.

Expansion Capacity Assessment	The meaning given to that term in clause 8.9.2 .
Expansion Capacity Deficit	The meaning given to that term in clause 8.9.4 .
Expansion Costs	The meaning given to that term in clause 6.4.4(a)(ii) .
Expansion Funder	An Access Seeker, Access Holder or its Customer who has entered into a User Funding Agreement with Aurizon Network.
Expansion Tariff	The tariff determined in accordance with Part 6 for a specified Reference Train Service in relation to an Expansion (as amended, varied or escalated in accordance with this Undertaking or the Act from time to time).
Expected Access Revenue	<ul style="list-style-type: none"> (a) For an individual Train Service, the revenue reasonably expected from the Access Charge from that Train Service; and (b) for a combination of Train Services, the aggregate revenue reasonably expected from the Access Charges for all Train Services comprising that combination of Train Services, where the expected Access Charges for different Train Services will be developed on a basis consistent with: <ul style="list-style-type: none"> (i) if a Reference Tariff is to be developed for a Train Service, the proposed Reference Tariff; (ii) the terms of the relevant Standard Access Agreement; and (iii) if paragraph (b)(i) of this definition does not apply, current applicable Access Charges, except as provided in clause 6.7.1(b)(iv).
Feasibility Funder	An Access Seeker or a Customer who is a party to a Studies Funding Agreement with Aurizon Network in respect of a Feasibility Study for an Expansion.
Feasibility Study	A study with the following scope of work:

- (a) detailed assessment of technical and operating requirements of the proposed Expansion (utilising the preferred alternative identified in the Pre-feasibility Study but having regard to the options identified in that Pre-feasibility Study);
- (b) all necessary survey and geotechnical investigations to support the level of design and cost accuracy commensurate with the procurement strategy developed as part of the Feasibility Study;
- (c) detailed design of the proposed Expansion solution to a level commensurate with the procurement strategy developed as part of the Feasibility Study;
- (d) independent design verification, if required by the Feasibility Funders; and
- (e) a written report.

The written report referred to above must include:

- (a) the outcome of the analysis, decisions and specifications referred to above (with reasons, where applicable);
- (b) the project objectives for the proposed Expansion;
- (c) a “for construction level” specification for the proposed Expansion;
- (d) definition of an optimised project configuration that will provide the Target Capacity for an Expansion in accordance with the capacity requirements specified as part of the Feasibility Study scope of works;
- (e) confirmation of the technical and economic feasibility of the preferred alternative identified in the Pre-feasibility Study;
- (f) financial evaluation of the proposed Expansion, including:
 - (i) the estimated impact on the System Reference Tariff and Expansion Tariff (including an appropriate Common Cost contribution);
 - (ii) the anticipated Expansion Tariff; and
 - (iii) an estimate of the Common Cost contribution, (determined in accordance with this Undertaking);
- (g) Capacity Analysis for the proposed Expansion to identify the target Capacity of the Expansion;

- (h) a detailed cost estimate for the proposed Expansion with a +/-10% level of accuracy (or a lower accuracy if agreed with the Feasibility Funders);
- (i) detailed design and construct project schedule for the proposed Expansion that includes:
 - (i) a fully statused program showing critical path;
 - (ii) time tolerances and project budget with a +/-10% margin (or lower accuracy if agreed with the Feasibility Funders);
 - (iii) an estimate of time and cost contingency supported by risk assessment and cost analysis;
 - (iv) probabilistic risk assessment analysis to establish the basis of project contingency; and
 - (v) a fully developed procurement methodology (including a report on previous approaches to the construction market undertaken by Aurizon Network, whether for the proposed Expansion or other works); and
- (j) a fully developed project management plan which includes:
 - (i) resource management plan;
 - (ii) cost management plan;
 - (iii) design management plan;
 - (iv) quality management plan;
 - (v) safety management plan;
 - (vi) schedule management plan;
 - (vii) risk management plan;
 - (viii) project packaging and delivery strategy;
 - (ix) procurement management plan;
 - (x) interface management plan;
 - (xi) change management plan;
 - (xii) environmental plan;
 - (xiii) project phases, milestones and deliverables;
 - (xiv) project risk assessment report; and
 - (xv) regulators notification, if needed.

Field Incident Management

The field management of incidents and accidents occurring on or affecting the Rail Infrastructure.

Force Majeure Event

Any cause, event or circumstance or combination of causes, events or circumstances which:

- (a) is beyond the reasonable control of the affected party; and
- (b) by the exercise of due diligence the affected party was not reasonably able to prevent or is not reasonably able to overcome,

and, provided that the requirements in **paragraphs (a) and (b)** of this definition are satisfied, includes:

- (c) compliance with a lawful requirement, order, demand or direction of an Authority or an order of any court having jurisdiction other than where that requirement, order, demand or direction results from any act or omission of the affected party;
- (d) a strike, lockout, stoppage, go slow, labour disturbance or other such industrial action, whether or not the affected party is a party to industrial action or would be able to influence or procure the settlement of such industrial action;
- (e) act of God;
- (f) war, invasion, terrorist act, act of foreign enemies, hostilities (whether war be declared or not), civil war, rebellion, revolution, insurrection, military or usurped power, blockade or civil commotion;
- (g) equipment failure or breakdown where such failure or breakdown could not have been prevented by Good Engineering Practices;
- (h) malicious damage or sabotage;
- (i) ionising radiations or contamination by radioactivity from any nuclear fuel or from any nuclear waste from the combustion of nuclear fuel;
- (j) failure of electricity supply from the electricity grid;
- (k) delay, restraint, restriction, embargo or other material adverse effect arising from any act or omission of any Authority;
- (l) fire, flood, storm surge, cyclone, tornado, earthquake, washaway, landslide, explosion severe weather conditions or other catastrophe or natural calamity;

	(m) epidemic or quarantine restriction; and
	(n) delay of a supplier due to any of the foregoing whether any such cause of delay exists before or after the Commencing Date.
Gamma	0.484, being the adjustment to the tax allowance for the value of dividend imputation credits as outlined within Appendix F of the QCA's 2018 Decision.
General Track Maintenance	Includes maintenance of Track, structures, civil, signalling, electrical overhead and telecommunication systems.
Good Engineering Practices	In respect of any undertaking in any circumstances, the exercise of that degree of care, foresight, prudence and skill that would reasonably and ordinarily be expected from a competent, skilled and experienced person in the same type of undertaking in the same or similar circumstances.
Goonyella Newlands Connection	The Rail Infrastructure between the North Goonyella mine junction and the Newlands mine junction.
Goonyella System	The Rail Infrastructure comprising the rail corridor from the ports at Hay Point and Dalrymple Bay to Hail Creek mine, Blair Athol mine, North Goonyella mine and the junction with the Gregory mine branch line and all branch lines directly connecting coal mine loading facilities to those corridors, with the exception of: <ul style="list-style-type: none"> (a) the branch line to Gregory mine; and (b) the corridor beyond North Goonyella mine to Newlands mine (and beyond).
Goonyella to Abbot Point System	The Rail Infrastructure comprising: <ul style="list-style-type: none"> (a) the Goonyella Newlands Connection; and (b) that part of any other Coal System which is used by a Train Service that also uses or connects to any part of the Goonyella Newlands Connection, except where that Train Service originates or terminates south of Gregory.
GST	The meaning given to that term in the A New Tax System (Goods and Services Tax) Act 1999 (Cth).
gtk	For an operated Train Service (whether loaded or empty) for a Train Service Type, gross tonne kilometres attributed to that Train Service being the amount which is the gross tonnes for the Train Service for the Train Service Type multiplied by:

	(a) if the Train Service was operated from the origin to destination for the Train Service Type, the number of kilometres of the loaded distance from origin to destination for the Train Service Type as specified in the Train Description for that Train Service Type; or
	(b) if the Train Service was operated from the destination to origin for the Train Service Type, the number of kilometres of the empty distance from the destination to origin for the Train Service Type as specified in the Train Description for that Train Service Type.
Gtk Forecast	The amount indicated as the 'Gtk Forecast' for the relevant Reference Tariff in Schedule F .
IE Initial Capacity Assessment	The meaning given to that term in clause 7A.4.1 .
IE Pass Through Cost	The meaning given to that term in clause 7A.3.4(a) .
Incremental Costs	Those costs of providing Access, including capital (renewal and expansion) costs, that would not be incurred (including the cost of bringing expenditure forward in time) if the particular Train Service or combination of Train Services (as appropriate) did not operate, where those costs are assessed as the Efficient Costs and based on the assets reasonably required for the provision of Access.
Independent Expert	The independent expert appointed under clause 7A.3.1 .
Indicative Access Proposal or IAP	The meaning given to that term in clause 4.6 .
Indicative Tonnage	Has the meaning given to that term in the Standard Access Agreement.
Indirect Maintenance Costs	The type of costs referred to in Section 8.8 of the QCA's 2018 Decision other than depreciation of maintenance assets referred to in Section 8.8.1 of the QCA's 2018 Decision.
Indirect Maintenance Cost Allowance	(a) For the Years commencing 1 July 2021 and 1 July 2022, is the amount specified in Schedule K for the 'Maintenance Costs – Indirect Allowance' for those Years; and (b) For the Year commencing 1 July 2023 and each subsequent Year, is an amount calculated in accordance with the following formula:

IMC allowance = Forecast cost base x Approved WACC

Where:

IMC allowance means the Indirect Maintenance Cost Allowance for a Year;

Forecast cost base means as at the date that the Indirect Maintenance Cost Allowance is submitted by Aurizon Network to the QCA pursuant to **Schedule F**, the forecast cost base of the relevant plant and inventory as at each of 1 July 2023, 1 July 2024, 1 July 2025 and 1 July 2026; and

Approved WACC means the 'Approved WACC' applicable at the relevant time.

Information Request Notice

The meaning given to that term in **clause 7.6(a)**.

Infrastructure Enhancement

Expansions and Customer Specific Branch Lines but excluding:

- (a) Asset Replacement and Renewal; or
- (b) Maintenance Work, required to deliver Committed Capacity.

Infrastructure Service Providers

Those parties who provide maintenance, construction and other related services in respect of the Rail Infrastructure.

Initial Capacity Analysis

A preliminary Capacity Analysis undertaken by:

- (a) for the period prior to the Initial Capacity Assessment Report being published by the QCA on its website as contemplated by **clause 7A.4.1(h)**, Aurizon Network; and

- (b) thereafter, the Independent Expert,

based on the most recent Capacity Assessment limited to:

- (g) an indicative assessment of whether there is sufficient Available Capacity (provided that where the Access Application relates to a Transfer, the Nominated Access Rights in the Transfer Notice are deemed to be Available Capacity) to accommodate requested Access Rights; and
- (h) if there is not sufficient Available Capacity, to accommodate the requested Access Rights either:
 - (i) an outline of the Expansions required to provide additional Capacity to accommodate the requested Access Rights (and an indicative

estimate of the cost of such works and the timing for completion); or

- (ii) if Aurizon Network has not carried out the investigations required to provide the information in **paragraph (i)**, an outline of the requirements for an investigation into the works required to accommodate the requested Access Rights.

Initial Capacity Assessment Report	The meaning given to that term in clause 7A.4.1(g) .
Initial Date	The date on which this Undertaking was submitted to the QCA for approval.
Initial Funding Notice	The meaning given to that term under clause 8.7.1(a) .
Insolvency Event	<p>Where one of the following events has happened in relation to the Access Seeker:</p> <ul style="list-style-type: none">(a) it is unable to pay all its debts as and when they become due and payable or it has failed to comply with a statutory demand as provided in section 459F(1) of the Corporations Act;(b) a meeting is convened to pass a resolution to place it in voluntary liquidation or to appoint an administrator unless the resolution is withdrawn within 10 Business Days or the resolution fails to pass;(c) an application is made to a court for it to be wound up and the application is not dismissed within 10 Business Days after it is made;(d) the appointment of a liquidator, provisional liquidator or controller (as defined in the Corporations Act) of any of its assets if that appointment is not revoked within 10 Business Days after it is made;(e) it resolves to enter into or enters into any form of arrangement (formal or informal) with its creditors or any of them, including a deed of company arrangement; or(f) any similar event occurs in respect of the Access Seeker under the laws of any jurisdiction other than Australia.
Inspecting Party	The meaning given to that term in clause 4.1(c) of Schedule C .

Interested Participant

The meaning given to that term in **clause 4.2(a)** of **Schedule E**.

Interface Coordination Arrangement

An arrangement that identifies the procedures to be followed and the responsible officers from both Aurizon Network and the Access Holder, in respect of all regular operational interfaces between the parties that arise in the exercise of rights and the performance of obligations under a Train Operations Deed other than those specified in the Network Management Principles.

Interface Risk Assessment

An assessment to:

- (a) identify all reasonably foreseeable Interface Risks and Environmental Risks;
- (b) assess:
 - (i) the likelihood of those Interface Risks and Environmental Risks occurring;
 - (ii) the consequences (including commercial consequences) of those Interface Risks and Environmental Risks occurring; and
 - (iii) any factors relevant to the effective management of those Interface Risks and Environmental Risks;
- (c) identify appropriate measures to effectively manage those Interface Risks and Environmental Risks within a risk management framework, including:
 - (i) an audit, inspection and review regime; and
 - (ii) applicable Safeworking Procedures and Safety Standards having regard to existing Aurizon Network and industry practices; and
- (d) identify the party responsible for implementing, complying with and/or ensuring compliance with the measures referred to in **paragraph (c)** of this definition and ensuring the ongoing effectiveness of such measures.

Interface Risks	<p>All risks to the safety of persons or property arising or potentially arising from the interaction between the Access Seeker's, Access Holder's or a Train Operator's proposed operations and:</p> <ul style="list-style-type: none"> (a) the Rail Infrastructure; (b) any land relating to the Rail Infrastructure; (c) activities on the Rail Infrastructure (including other Train Services) or any land relating to the Rail Infrastructure; or (d) persons on, using or near the Rail Infrastructure or any land relating to the Rail Infrastructure.
Interim Renewals Strategy and Budget	The meaning given to that term in clause 7A.11.3(o) .
Intermediate Train Plan or ITP	A plan that details the indicative scheduled times for all Train Services and Planned Possessions, Urgent Possessions and Emergency Possessions on a specified part of the Rail Infrastructure on each day of the Relevant Period.
IRMP	An interface risk management plan which sets out each of the matters required to be identified and assessed during an Interface Risk Assessment.
Issues Register	The register maintained by Aurizon Network under clause 10.5.3(c) .
JORC Code	The current edition of the <i>Australasian Code for Reporting of Exploration Results, Mineral Resources and Ore Reserves</i> prepared by the Australasian Joint Ore Reserves Committee, from time to time.
Key AN Commercial Personnel	<p>For the purposes of Part 3:</p> <ul style="list-style-type: none"> (a) the Head of Network Customers of Aurizon Network (or equivalent); and (b) any direct reports of the Head of Network Customers of Aurizon Network (or equivalent).
Later Expansion Agreements	The meaning given to that term under clause 8.2.3(a)(v) .
Law	<ul style="list-style-type: none"> (a) Any statute, rule, regulation, code, proclamation, ordinance or by-law, present or future, whether State, Commonwealth or otherwise; and (b) any requirement, condition, notice, consent, accreditation, order or direction or similar thing of any statutory, public or other competent authority

(including the State in any of its regulatory capacities), present or future, given or imposed pursuant to anything specified in **paragraph (a)** of this definition.

Limited Update Inputs	The items listed in clause 6A.5(b) .
Line Diagrams	<p>A diagrammatical representation of the rail network identifying:</p> <ul style="list-style-type: none">(a) the configuration of the rail network; and(b) the parts of the rail network which are managed by Aurizon Network, a Related Operator or a person other than Aurizon Network.
Load Variation Table	A table published by Aurizon Network in respect of a nominated Reference Train Service or type of Train Service identifying allowable overloads for wagons and bogies and specifying relevant Operational Constraints and additional charges, where applicable, for such overloads.
Loading Time	The time between a Train Service arriving at a Nominated Loading Facility and that same Train departing the Nominated Loading Facility, and for the purpose of clarity, this time runs from when a Train Service arrives at the entry signal to the Nominated Loading Facility until it has completed loading, presented at the exit signal, is ready to depart the Nominated Loading Facility and has advised the relevant Network Controller accordingly.
Long Term Transfer	The meaning given to that term in clause 7.4.1(d)(iii) .
Mainline Path	That part of any Train Path (in relation to a Coal System) as shown in the Preliminary Information.
Maintenance Costs Claim	The meaning given to that term in clause 7A.11.5(c) .
Maintenance Indicator	The annual maintenance allowance approved by the QCA, from time to time, for the purpose of assessing the relevant Reference Tariffs.
Maintenance Objectives	The meaning given to that term in clause 7A.11.1 .
Maintenance Strategy and Budget	<p>A document which sets out in reasonable detail for each Coal System for a Year and for a forecast period of not less than an additional four Years:</p> <ul style="list-style-type: none">(a) the strategy for Maintenance Work that Aurizon Network proposes to undertake or procure in the

relevant Year on a Coal System basis and on an aggregate basis including with respect to the following categories of maintenance:

- (i) general track maintenance;
- (ii) structures and facilities maintenance;
- (iii) other civil maintenance;
- (iv) trackside systems maintenance;
- (v) electrical overhead maintenance;
- (vi) signalling and telecommunications maintenance;
- (vii) other general maintenance,
- (viii) and the scope for:
 - (A) resurfacing; and
 - (B) rail grinding,

(Maintenance Scope of Work);

- (b) high level description of the maintenance practices used to carry out the Maintenance Scope of Work;
- (c) a description of the forecast throughput impacts of the Maintenance Strategy and Budget compared against:
 - (i) for the Year commencing 1 July 2019, the throughput achieved and being achieved taking into account the maintenance activities that were conducted in the Year commencing 1 July 2018; and
 - (ii) for each subsequent Year, the throughput achieved and being achieved taking into account the maintenance activities that were conducted in accordance with the most recently Approved Maintenance Strategy and Budget or if there has been no Approved Maintenance Strategy and Budget, the Approved Maintenance Approach; an indicative timetable for the Maintenance Scope of Work;
- (d) the key deliverables for the Maintenance Scope of Work;
- (e) the procurement strategy and methodology for the Maintenance Scope of Work;

- (f) a high level description of the impact of the Maintenance Strategy on the Coal Systems and the Supply Chains; and
- (g) a budget for the Maintenance Scope of Work, as determined by Aurizon Network provided however that it must:
 - (h) be consistent with Aurizon Network's obligations under **clauses 7A.11.1(a)(iii)(A) and 7A.11.1(a)(iii)(C)**; and
 - (i) not include an amount of Aurizon Network's forecast maintenance costs for non-coal traffic in line with the QCA's 2018 Decision allocation methodology.

Maintenance Strategy and Budget for a Coal System

The Maintenance Strategy and Budget to the extent it relates to the Coal System.

Maintenance Work

Any work involving maintenance or repairs to, or renewal, replacement and associated alterations or removal of, the whole or any part of the Rail Infrastructure (other than Infrastructure Enhancements) and includes any inspections or investigations of the Rail Infrastructure.

Major Periodic Maintenance

Activities that renovate the Rail Infrastructure to retain it in a functional condition completed on Track sections at intervals of more than one year, and includes activities such as re-railing, rail grinding, resurfacing, re-signalling, communications upgrades, renovating structures, ballast cleaning and re-sleepering.

Major Yards

The yards at Callemondah, Jilalan, Coppabella, and Pring.

Majority of End Users	<p>In respect of End Users with Access Rights in:</p> <ul style="list-style-type: none"> (a) where a Majority of End Users for a Coal System is required, the relevant Coal System; or (b) where a Majority of End Users generally is required, any Coal System <p>(Voting End Users):</p> <ul style="list-style-type: none"> (c) a number of Voting End Users that in aggregate hold at least 60% of the End User Voting Rights (Coal System) or End User Voting Rights (Network) (as applicable) held by the Voting End Users for the Year; and (d) if the threshold in paragraph (c) is not satisfied: <ul style="list-style-type: none"> (i) at least 50% of Voting End Users by number at the relevant time; and (ii) a number of Voting End Users that, in aggregate, hold at least 50% of the End User Voting Rights (Coal System) or End User Voting Rights (Network) (as applicable) held by the Voting End Users for the Year.
Master Train Plan or MTP	That document detailing the distribution of Train Service Entitlements as advised by Aurizon Network from time to time for all Train Services and any Planned Possessions on a specified part of the Rail Infrastructure.
Material Default	<ul style="list-style-type: none"> (a) Failure on more than one occasion to comply with any terms or conditions of a relevant agreement where that breach would not lawfully justify termination; or (b) a breach of a term or condition of a relevant agreement where that breach would lawfully justify termination, <p>where a “relevant agreement” is an agreement described in clause 4.13(b)(ii).</p>
Material Variation	<p>A variation to the relevant Access Application that will be detrimental to another Access Holder or Access Seeker’s Capacity allocation as a result of either (or both):</p> <ul style="list-style-type: none"> (a) the relevant Access Rights, if granted, being allocated more Capacity including any increase in tonnages to be carried by Train Services or in the required number of Train Paths; or (b) changes:

- (i) in the Capacity consumed by Train Services relating to the Access Rights being sought as a result of the variation – except to the extent that the changes are to make the Train Service consistent with the description of the relevant Reference Train Service (if any);
- (ii) the period for which the Access Rights are required, whether shorter or longer;
- (iii) the nature or type of Access Rights (for example, from Cyclic Traffic to Timetabled Traffic); or
- (iv) the origin or destination relevant to the Access Rights.

Maximum Allowable Revenue	The maximum revenue that Aurizon Network should be entitled to earn by way of Access Charges from the provision of Access to the relevant Train Service(s) over the Evaluation Period, as determined in accordance with clause 6.6.3 .
Maximum Payload	Has the meaning given to that term in the Standard Access Agreement.
Minimum Revenue Contribution	For the purposes of clause 6.3, the amount calculated under clause 6.3.1(c)(ii).
Month	A calendar month.
Moura System	The Rail Infrastructure comprising the rail corridor from the port of Gladstone (including domestic coal terminals in the vicinity of Gladstone) to Moura mine and the loading facility for Baralaba mine in the vicinity of Moura mine, and all branch lines directly connecting coal mine loading facilities to that corridor but excluding the corridor to Blackwater (and beyond).
Mutually Exclusive Access Applications	In respect of: <ul style="list-style-type: none"> (a) two or more Access Applications where if Aurizon Network grants Access Rights in respect of one or more of those Access Applications then there will be insufficient Available Capacity to grant Access Rights in respect of the remaining Access Applications; and (b) one or more Access Application(s) and a proposed transfer which requires Ancillary Access Rights, where if Aurizon Network grants Access Rights in respect of the Access Application(s) then there will be insufficient Available Capacity to grant the Ancillary Access Rights in respect of the transfer.

Negotiation Cessation Notice	A notice issued by Aurizon Network in accordance with clause 4.13 .
Negotiation Period	The period during which the terms and conditions of an Access Agreement will be negotiated, as described in clause 4.11.1 .
Negotiation Process	The meaning given to that term in clause 5.1(a) .
Network Control Services	<p>The management and monitoring of all Train Movements and of all other operation of Rollingstock on the Rail Infrastructure and of any activities affecting or potentially affecting such Train Movements or Rollingstock operation including:</p> <ul style="list-style-type: none"> (a) recording Train running times on Train diagrams and in Aurizon Network's information systems; (b) reporting of incidents occurring on the Rail Infrastructure; (c) managing incidents occurring on the Rail Infrastructure from within a Network Control centre; (d) Field Incident Management and Yard Control services; and (e) exchanging information with Railway Operators, and Network Control has a related meaning.
Network Controller	A person performing Network Control Services from within a Network Control centre.
Network Development Plan	A plan setting out options and indicative plans relating to the short and medium term development, extension, use, or improvement of, or capital investment in, or interaction with, the Coal Systems to promote increased Capacity, which contains the information outlined in clause 7A.10 .
Network Incident	<p>Any derailment, disablement or breakdown of Rollingstock, accident, collision or other unplanned occurrence, on or affecting the use of the Rail Infrastructure which causes or contributes to, or could cause or contribute to:</p> <ul style="list-style-type: none"> (a) the death of, or injury to, any person; (b) damage to any property; (c) Environmental Harm; or (d) a disruption to, or cancellation by Aurizon Network of any Train Movement.

Network Management Principles	The principles set out in Schedule G and all System Rules existing from time to time.
New Access Agreement	An Access Agreement to the extent entered into or varied for the purpose of a Transfer from an Old Access Agreement.
New Expansion	The meaning given to that term in clause 6.4.5(b) .
Newlands System	The Rail Infrastructure comprising the rail corridor from the port of Abbot Point to Newlands mine, and all branch lines directly connecting coal mine loading facilities to that corridor, with the exception of the corridor between the Newlands mine and the North Goonyella mine (and beyond).
ntk	The net tonne kilometres attributed to the relevant Train Service, being the nt for the Train Service multiplied by the distance (in kilometres) from origin to destination for the Train Service as set out, from time to time, in the Access Agreement relating to that Train Service or, where there is no Access Agreement or the Access Agreement does not set out that distance, as determined by Aurizon Network (acting reasonably).
Nominal Payload	Has the meaning given to that term in the Standard Access Agreement.
Nominal Train Payload	The nominal nt that applies to the Train Service as specified under the System Reference Tariff or Expansion Tariff (such as, for the System Reference Tariffs under clause 7.2(f)(e), 8.2(d), 9.2(c), 10.2(c) and 11.2(b) of Schedule F), as applicable.
Nominated Access Rights	As applicable: (a) in clause 7.4.1 (Transfers), the meaning given to that term in clause 7.4.2(a)(ii) ; and (b) in clause 7.4.8 (Relinquishments), the meaning given to that term in clause 7.4.8(b)(i) .
Nominated Infrastructure	That Rail Infrastructure over which the relevant Reference Train Service travels between the Nominated Loading Facility/ies and Nominated Unloading Facility/ies.
Nominated Loading Facility	A loading facility specified for a nominated Reference Train Service in Schedule F .

Nominated Monthly Operational Rights	Has the meaning given to that term in the Standard Train Operations Deed.
Nominated Monthly Train Services	Has the meaning given to that term in the Standard Access Agreement.
Nominated Network	The meaning given to that term in the Standard Access Agreement.
Nominated Railway Operator	For an Access Holder, a Railway Operator nominated or appointed by that Access Holder in accordance with an Access Agreement for the purpose of operating Train Services for that Access Holder for specified periods in accordance with that Access Holder's Access Rights.
Nominated Unloading Facility	An unloading facility specified for a nominated Reference Train Service in Schedule F .
Nominee Operator	The meaning given to that term in clause 4.10.1(a) .
Non-availability Circumstances	<p>The following requirements:</p> <ul style="list-style-type: none"> (a) the relevant person has notified Aurizon Network that the evidence or information is not available and is not reasonably able to be produced, procured or otherwise obtained, including providing the relevant supporting facts or circumstances. (For example, the relevant facts or circumstances may relate to the development of the project being at too early a stage for the person to be able to produce or procure the relevant evidence or information.); and (b) having regard to the information provided under paragraph (a) of this definition, Aurizon Network (acting reasonably) is satisfied that: <ul style="list-style-type: none"> (i) the evidence or information is not available and is not reasonably able to be produced, procured or otherwise obtained; and (ii) the failure or inability does not indicate a lack of genuine intention to obtain the requested Access Rights or a reasonable likelihood that the Access Rights will not be utilised at the level sought.
Non-Electric Operating Expenditure Allowance	An allowance to compensate Aurizon Network for those costs outlined within Sections 7.5, 7.6 and 7.7 of the QCA's 2018 Decision (Non-Electric Operating Expenditure Costs) and:

- (a) for the purposes of **clause 6A.2(b)(iv)**, the amount of Non-Electric Operating Expenditure Costs used in the calculation of the Reference Tariffs and Allowable Revenues for the Year ending 30 June 2022; and
- (b) for the purposes of **clause 6A.5(b)(i)(D)**, the amount of Non-Electric Operating Expenditure Costs used in the calculation of the Reference Tariffs and Allowable Revenues for the Year ending 30 June 2023.

Notice of Intention to Relinquish	The meaning given to that term in clause 7.4.8(a) .
nt	Unless otherwise specified, the net tonnes attributed to the relevant Train Service, being the total gross weight (in tonnes) of the Rollingstock when loaded utilised in the relevant Train Service (including all goods, product, persons or matter carried) less the weight of such Rollingstock (in tonnes) when empty.
Old Access Agreement	In relation to a New Access Agreement, the pre-existing Access Agreement to which the relevant Transfer relates.
Operating Plan	A description specifying reasonable details of how the proposed Train Services are to be operated, including the matters required in Schedule C .
Operational Constraint	Any restriction on the use of any part of the Rail Infrastructure that impacts adversely on Train Services, including speed restrictions, load restrictions, Possessions or signalling or overhead restrictions.
Origin System	The Coal System on which the Nominated Loading Facility is located.
Origin Tariff	The relevant Reference Tariff applying to the relevant Cross System Train Service in the Origin System.
Out-Of-Course Running	The circumstance that occurs when the actual running of one or more Train Service/s differs by more than the relevant agreed threshold/s as set out in the relevant Access Agreement, from that provided in the DTP.
Overload Charges	Charges that penalise the overloading of train wagons.
Passenger Priority Obligation	The obligations of a Railway Manager pursuant to sections 265 and 266 of the TIA.
Payload	Of a Train Service means the weight of product loaded onto any Train used in operating that Train Service.
Performance Delay	The meaning given to that term in clause 8.6(a)(i)(C) .

**Performance
Rebate Amount**

means an amount calculated as follows:

$$\text{PRA} = \text{A} \times \text{R}$$

Where:

PRA means Performance Rebate Amount (expressed in dollars);

A means the AN Performance Shortfall for a Relevant Year (expressed as a number of Train Service Entitlements) to the extent attributable to an AN Performance Breach; and

R means the revenue from the Relevant Components of Access Charges that Aurizon Network would have been entitled to earn for the applicable Train Service Entitlement.

Planned Capacity

(a) For the period prior to the Initial Capacity Assessment Report being published by the QCA on its website as contemplated by **clause 7A.4.1(h)**, the additional Train Paths (calculated on a Monthly and annual basis) that are expected to result from an Expansion that Aurizon Network is contractually committed to construct, taking into account:

- (i) Aurizon Network's reasonable requirements for the exclusive or partial utilisation of the Rail Infrastructure resulting from that Expansion for the purposes of performing activities associated with the maintenance and repair of the Rail Infrastructure resulting from that Expansion, including the operation of work Trains; and
- (ii) Aurizon Network's allowances for "day of operations" losses, speed restrictions and other operational losses or restrictions applicable to the Rail Infrastructure resulting from that Expansion as set out in the System Operating Parameters;

(b) thereafter, the additional Deliverable Network Capacity expected to result from an Expansion that Aurizon Network is contractually committed to construct as contemplated by **clause 07A.5** or **Part 8**.

**Planned
Possession**

A Possession that may adversely impact upon the operation of Train Services and is notified to Access Holders at least twenty-one (21) days prior to taking effect and, for clarity, includes Maintenance Work.

Port Precinct

The meaning given to that term in **clause 7.4.1(d)**.

Possession	The temporary closure and/or occupation by Aurizon Network on part of the Rail Infrastructure (including closure of Track or isolation of any electrical overhead traction system) for the purposes of carrying out Planned Possession, Urgent Possession or Emergency Possession on or in the proximity of the Rail Infrastructure which may affect the safety of any person or property.
Possession Protocols	The protocols developed and advised by Aurizon Network from time to time (as varied in accordance with any Access Agreement) for managing and scheduling Possessions.
Potential Feasibility Funders	In respect of a proposed Feasibility Study, the Access Seekers (or if applicable, Customers or Conditional Access Holders) who are required to be given an opportunity to fund that Feasibility Study as determined in accordance with clause 8.4.3(a) .
Potential Pre-feasibility Funders	In respect of a proposed Pre-feasibility Study, the Access Seekers (or if applicable Customers or Conditional Access Holders) who are required to be given an opportunity to fund that Pre-feasibility Study as determined in accordance with clause 8.4.2(c) .
Pre-30 June 2006 Coal Access Agreements	<p>(a) Access Agreements in place on the day immediately prior to 30 June 2006; or</p> <p>(b) new Access Agreements entered as part of transferring Access Rights from such Access Agreements but only to the extent that the terms of the Access Agreement described in paragraph (a) apply in respect of the relevant Access Rights.</p>
Pre-Approval Date Coal Access Agreements	<p>(a) Access Agreements in place on the day immediately prior to the Approval Date; or</p> <p>(b) new Access Agreements entered as part of transferring Access Rights from such Access Agreements but only to the extent that the terms of the Access Agreement described in paragraph (a) apply in respect of the relevant Access Rights,</p> <p>but does not include a Pre-30 June 2006 Coal Access Agreement.</p>
Pre-feasibility Funder	An Access Seeker or a Customer who is a party to a Studies Funding Agreement with Aurizon Network in respect of a Pre-feasibility Study for an Expansion.
Pre-feasibility Study	<p>A study with the following scope of work:</p> <p>(a) identification and assessment of all technical solutions that a prudent engineering consultant would</p>

identify and assess, to deliver the required Capacity, taking into account the full Supply Chain;

- (b) assessment of technical and operating requirements of the proposed Expansion;
- (c) Capacity Analysis of:
 - (i) the proposed Expansion; and
 - (ii) any alternatives identified in **paragraph (a)** above,

based on the most recent Capacity Assessment, or if a Capacity Assessment has not been completed at the relevant time, the most recent Capacity Analysis undertaken by Aurizon Network;

- (d) all necessary survey and geotechnical investigations to support the level of design and cost accuracy required in **paragraph (g)** below;
- (e) identification of a single preferred solution for the proposed Expansion (to be studied in detail during the Feasibility Study phase);
- (f) high level value engineering assessment of the preferred solution to lower the total cost of ownership, after allowing for risk, of the proposed Expansion; and
- (g) a written report.

The written report referred to above must include:

- (h) the project objectives for the proposed Expansion;
- (i) the outcome of the analysis, decisions and specifications referred to above (with reasons, where applicable);
- (j) evaluation of all of the project configuration alternatives that would provide the Capacity requirements of the proposed Expansion;
- (k) preliminary risk assessment of the proposed Expansion, including the alternatives identified in **paragraph (a)** above;
- (l) identification of the project configuration alternative (referred to in **paragraph (a)** above) that has the lowest total cost of ownership, after allowing for risk;
- (m) analysis of the technical and economic feasibility of the preferred alternative and provides reasons why it is the preferred alternative;

- (n) design and construct project schedule for preferred alternative for the proposed Expansion that includes time tolerances and project budget with a+/-20% margin;
- (o) potential benefits, including capacity, maintenance and operating benefits of the proposed Expansion;
- (p) the design, estimate and schedule of the preferred alternative for the proposed Expansion, including;
- (q) details of any variation to the budgeted costs to undertake the Pre-feasibility Study; and
- (r) a Feasibility Study execution plan, including the scope of work (taking into account the scope of work required by the definition of “Feasibility Study” in this Undertaking), budget, time schedule and deliverables.

Preliminary Information

The information referred to in **clause 1 of Schedule A** (as applicable) and, where that information is published on the Website, that information as published on the Website from time to time.

Preliminary Limited Update Inputs

The items listed in **clause 6A.2(b)**.

Preserved Train Path Obligations

The obligations of a Railway Manager under section 266A of the TIA.

Pricing Proposal

The meaning given to that term in **clause 6.4.4(a)**.

Private Efficient Cost

The cost for each Year, during the period for which the relevant Reference Tariff will apply, that reflects the costs that would be reasonably expected to be incurred by a Railway Manager adopting efficient work practices in the provision of the relevant Private Infrastructure to the required service standard.

Private Incremental Costs	<p>For the purposes of clause 6.3, those costs of providing access to the relevant Private Infrastructure (including Connecting Infrastructure owned by Aurizon Network but funded by a Private Infrastructure Owner), including capital (renewal and expansions) costs, that would not be incurred (including the cost of bringing expenditure forward in time) if the particular Train Service or combination of Train Services (as appropriate) did not operate, where those costs:</p> <ul style="list-style-type: none"> (a) are assessed as Private Efficient Costs and based on the assets reasonably required for the provision of access to the relevant Private Infrastructure; (b) have been reviewed and endorsed by the QCA; (c) have not been included in Allowable Revenue; and (d) have been submitted to Aurizon Network by the owner or operator of the relevant Private Infrastructure for the purpose of calculating the relevant tariffs.
Private Infrastructure	The rail transport infrastructure (as defined under the TIA), including track, signalling and electrical overhead traction system (if applicable), that is not Rail Infrastructure.
Private Infrastructure Owner	A person who owns, or proposes to construct and own, Private Infrastructure which will connect to the Rail Infrastructure in order to allow Trains operating on that Private Infrastructure to enter or exit from the Rail Infrastructure for the purposes of Access.
Projected Cost	The projected cost, including capital, maintenance and operating costs, (on a “most likely case” basis) of an Expansion applying the costing details and approach specified in the Pre-feasibility Study report for the Expansion to the capacity requirements of the Feasibility Funders in relation to the Feasibility Study for the Expansion.
Proposed Amendments	The meaning given to that term in clause 7A.7.4(c)(i)(F) .
Proposed Standard Rail Connection Agreement	A proposed pro forma Rail Connection Agreement as contemplated in clause 9.2 .
Proposed System Rules	The meaning given to that term in clause 7A.7.5(a) .

Prospective Access Seeker	A person who notifies Aurizon Network that the person wants Access, or increased Access, but has not yet provided Aurizon Network with a properly completed Access Application.
Provisional Capacity Allocation	The meaning given to that term in clause 8.5(b) .
PV Amount	The meaning given to that term: (a) in respect of Transfers, in clause 7.4.6(c) ; and (b) in respect of Relinquishments, in clause 7.4.8(e)(ii) .
QCA	The Queensland Competition Authority as established by the Act.
QCA Levy	The fee allocated to the nominated Train Services to cover the fees imposed by the QCA on beneficiaries of its regulatory services and, for a Reference Train Service, is that amount specified as such for that Reference Train Service in Schedule F .
QCA's 2018 Decision	The QCA's decision in relation to Aurizon Network's 2017 Draft Access Undertaking issued on 6 December 2018.
QCA Consolidation DAAU Decision	The QCA's decision to approve Aurizon Network's Consolidation DAAU issued on 21 February 2020.
Quarter	Each period of three consecutive Months commencing each 1 July, 1 October, 1 January and 1 April in each year.
Queensland Rail	Queensland Rail Limited ACN 132 181 090.
Queue	The meaning given to that term in clause 7.5.2(b) .
Rail Connection Agreement	An agreement by which Aurizon Network agrees to the connection of Private Infrastructure to the Rail Infrastructure.
Rail Industry Group	A forum of End Users established for the purposes referred to in clause 7A.11.2(c) .
Rail Infrastructure	Rail transport infrastructure (as defined under the TIA) for which Aurizon Network is the owner or lessee, the use of which is taken to be a service declared for the purposes of Part 5 of the Act pursuant to section 250(1)(a) of the Act.
Rail Safety Act	Rail Safety National Law (Queensland) Act 2017 (Qld).
Railway Manager	The meaning given to that term in the TIA.
Railway Operator	The meaning given to that term in the TIA and, for clarity, includes an Access Holder's nominated Train Operator.

Rapid Capacity Assessment	A Capacity Analysis which is limited to an analysis of Available Capacity based on the Baseline Capacity Assessment if a Capacity Assessment has not been completed at the relevant time, or the most recent Capacity Assessment (if any) and any subsequent changes to the Available Capacity to determine if there is sufficient Available Capacity (if the Nominated Access Rights are deemed to be Available Capacity for the purposes of the Rapid Capacity Assessment) for the Transferred Access Rights.
Rebate	The meaning given to that term under clause 7A.6(b) .
Recipient	A person or entity to whom access to or disclosure of Confidential Information is made.
Reduced Conditional Access Rights	The Access Rights for a Segment of an Expansion, as determined in accordance with the formula in clause 8.9.5(b) .
Reduction Factor	The amount calculated in accordance with clause 7.4.9(d) .
Reference Tariff Provisions	The provisions set out in Schedule F .
Reference Tariffs	System Reference Tariffs and Expansion Tariffs.
Reference Train Service	A notional Train Service described in clause 1.3 of Schedule F .
Regulatory Asset Base	The asset value for the Rail Infrastructure accepted by the QCA for the purpose of developing Reference Tariffs for coal carrying Train Services.
Rejection Notice	The meaning given to that term in clause 4.4(e) .
Related Competitors	Functional units within the Aurizon Group or an Aurizon Party that has a direct or indirect interest (whether as owner, lessee, trust unit holder, operator, manager or otherwise and whether alone or together with others) in a: <ul style="list-style-type: none"> (a) port; or (b) coal mine or coal-extraction project, that is an origin or destination for any good conveyed over the Rail Infrastructure.
Related Operators	Functional units within the Aurizon Group that provide Above Rail Services.
Related Party	A related body corporate as defined in the Corporations Act.
Relevant Component	Of an Access Charge means AT2 to AT5 components of Access Charges based on the Reference Tariffs which

	applied to the relevant origin and destination in the final Month of the Relevant Year, and where no Reference Tariff applied, the most recent Reference Tariff that applied to the relevant origin and destination.
Relevant Period	The relevant seven day period commencing at 12:00 am on Monday and ending immediately prior to 12:00 am on the following Sunday or such other period as expressly specified in the relevant System Rules.
Relevant Tax	Any tax, charge, levy, duty, impost, rate, royalty or imposition which is imposed on Aurizon Network by, or payable by Aurizon Network to, any Authority but does not include any fringe benefits tax, capital gains tax or any tax that replaces any of those taxes.
Relevant Year	The meaning given to that term under clause 8.2.1(b)(ii)(B).
Relinquishment Date	The meaning given to that term in clause 7.4.8(b)(ii) .
Relinquishment Fee	The relinquishment fee determined in accordance with clause 7.4.8(e) .
Renewal	The meaning given to that term under clause 7.3(a) .
Renewals Capex Claim	The meaning given to that term under clause 7A.11.6(a).
Renewals Strategy and Budget	<p>A document which sets out in reasonable detail for each Coal System for a Year and for a forecast period of not less than an additional 4 Years:</p> <ul style="list-style-type: none"> (a) the scope of Asset Replacement and Renewal work that Aurizon Network proposes to undertake or procure in the relevant Year on a Coal System basis and on an aggregate basis including any work that was regarded in the QCA's 2018 Decision as ballast undercutting (Renewals Scope of Work); (b) the high level practices used to carry out the Renewals Scope of Work; (c) a description of the forecast throughput impacts of the Renewals Strategy and Budget compared against: <ul style="list-style-type: none"> (i) for the Year commencing 1 July 2019, the throughput achieved and being achieved taking into account the Asset Replacement and Renewal Work that was conducted in the Year commencing 1 July 2018; and

- (ii) for each subsequent Year, the throughput achieved and being achieved taking into account the Asset Replacement and Renewal work that was conducted in accordance with the most recently Approved Renewals Strategy and Budget or if there has been no Approved Renewals Strategy and Budget, the Asset Replacement and Renewal Work that was conducted in the previous Year;
- (d) an indicative timetable for the Renewals Scope of Work;
- (e) the key deliverables for the Renewals Scope of Work;
- (f) the procurement strategy and methodology for the Renewals Scope of Work;
- (g) a high level description of the impact of the Renewals Strategy on the Coal Systems and Supply Chains; and
- (h) a budget for the Renewals Scope of Work, as determined by Aurizon Network.

Renewals Strategy and Budget for a Coal System The Renewals Strategy and Budget to the extent it relates to the Coal System.

Renewing Access Seeker The meaning given to that term under **clause 7.3(a)**.

Replacement The meaning given to that term under **clause 8.5(g)**.

Report Date The date on which the last of the following events has occurred:

- (a) the Independent Expert has provided the Initial Capacity Assessment Report to Aurizon Network and the Chair of the Rail Industry Group; and
- (b) Aurizon Network notifies the Chair of the Rail Industry Group of the proposed options for addressing any Existing Capacity Deficits identified in the Initial Capacity Assessment Report, provided that where the Initial Capacity Assessment Report does not identify any Existing Capacity Deficits, Aurizon Network will be deemed to have satisfied the notification requirement in this **paragraph (b)** on the date that the Initial Capacity Assessment Report has been provided in accordance with **paragraph (a)**.

Reset Date 1 July 2023.

Reset Debt Risk Premium	A forecast debt risk premium for the Reset Period calculated by applying the methodology referred to in Appendix F of the QCA's 2018 Decision (including the simple portfolio econometric estimation methodology (PwC methodology)) for BBB+ rated corporate bonds. This is calculated in a manner consistent with the way in which the debt risk premium was calculated in the QCA's 2018 Decision by an expert appointed by the QCA, using criteria consistent with that adopted to calculate the debt risk premium in the QCA's 2018 Decision, and using an average over the 20 Business Day period up to (and including) 30 June 2023.
Reset Debt Risk Premium Difference	An amount calculated in accordance with the following formula: (Reset Debt Risk Premium - 2.04%) x 0.55
Reset Inflation Rate	A forecast inflation rate for the Reset Period calculated as the arithmetic average of the midpoint of short-term Reserve Bank of Australia (RBA) inflation rate forecasts for the period from 1 July 2023 to the period that the RBA reports short-term inflation forecasts and the midpoint of the RBA target band for inflation for the years to the Terminating Date (if any) that short-term RBA inflation rate forecasts are not available.
Reset Period	The Years commencing 1 July 2023, 1 July 2024, 1 July 2025 and 1 July 2026 inclusive.
Reset Risk Free Rate	The average of the Risk Free Rate at the close of business on each of the 20 Business Days up to (and including) 30 June 2023.
Reset Risk Free Rate Difference	An amount calculated in accordance with the following formula: Reset Risk Free Rate - 1.90%
Reset Schedule F Preliminary Values	The meaning given to that term in clause 6A.2(a) .
Reset Schedule F Values	The meaning given to that term in clause 6A.5(a) .
Reset WACC	(a) Subject to paragraph (b), an amount calculated in accordance with the following formula: A + B + C Where: A is:

- (i) subject to **clause 7A.6(k)**, if the Report Date has occurred by the Reset Date, 6.3% p.a.; or
- (ii) if the Report Date has not occurred by the Reset Date, 5.9% p.a.

B is the Reset Risk Free Rate Difference; and

C is the Reset Debt Risk Premium Difference.

- (b) Where A(ii) applies, the Reset WACC that will apply from the Report Date will be:

$$A + B + C + D$$

Where:

A is 5.9% p.a.;

B is the Reset Risk Free Rate Difference;

C is the Reset Debt Risk Premium Difference; and

D is, subject to **clause 7A.6(k)**, 0.4%.

Resumed Access Rights	For a Train Service Type, the meaning given to that term in clause 7.6(e)(ii)(A) .
Resumption Date	The meaning given to that term in clause 7.6(e)(ii)(B) .
Resumption Notice	The meaning given to that term in clause 7.6(d) .
Resumption Trigger Event	The meaning given to that term in clause 7.6(a) .
Return of Capital (Depreciation)	The amount estimated as return of capital for assets included within the Regulatory Asset Base as described in Section 3 of the QCA's 2018 Decision
Return of Capital minus Inflation	The Return of Capital (Depreciation) for the year minus the inflationary gain from indexation of the asset base, based on CPI Forecast.
Return on Capital	The amount estimated as the weighted average cost of capital multiplied by the value of the Regulatory Asset Base as outlined within Section 1 of the QCA's 2018 Decision.
Revenue Adjustment Amounts	Collectively the AT ₂₋₄ Revenue Adjustment Amount and the AT ₅ Revenue Adjustment Amount and Revenue Adjustment Amount means one of them.
Review Event	The occurrence of any of the events listed in clause 5.3 of Schedule F .

Revised Standard Rail Connection Agreement	The standard form of Rail Connection Agreement approved by the QCA under clause 9.2(g) .
Risk Free Rate	The rate for Commonwealth of Australia Government nominal bonds using the RBA indicative mid-rate with a term of 4 years, estimated using methodologies consistent with those applied by the QCA in the development of the rate of 1.9% as set out in Appendix F of the QCA's Final Decision.
ROA	The meaning given to that term in clause 6.6.3(c) .
Rollingstock	Locomotives, carriages, wagons, rail cars, rail motors, light rail vehicles, light inspection vehicles, rail/road vehicles, trolleys and any other vehicle that operates on or uses the Track.
Rollingstock Configuration	The description of the combination of Rollingstock comprising a Train including identification number and gross mass of individual items of Rollingstock and the order in which those Rollingstock items are placed in the Train.
Rollingstock Interface Standards	The minimum standards relating to Rollingstock and Rollingstock Configurations specified in Aurizon Network's document entitled "Interface Standards" published on the Website (as amended and replaced from time to time).
rtp	The number of reference Train Paths used by the relevant Train Service calculated in accordance with clause 6.2.3(c) .
Safety Management System	Aurizon Network's safety management system as required under the Rail Safety Act.
Safety Regulator	The rail safety regulator as defined under the Rail Safety Act.
Safety Standards	All standards relating to safety, including occupational health and safety, established in published guidelines, industry practice or Aurizon Network policies and all standards relating to safety, including occupational health and safety, prescribed by any Laws.

Safeworking Procedures	<p>The procedures and systems, including supporting communications systems, for the safe operation of Trains and protection of worksites on the Infrastructure specified in Aurizon Network’s document entitled Safeworking Procedures as:</p> <ul style="list-style-type: none"> (a) notified by Aurizon Network to the relevant Train Operator; or (b) published on the Website, (as amended and replaced from time to time).
SAR Relinquishment Fee	<p>For the Surplus Access Rights for a Train Service Type means the amount calculated in accordance with clause 13.5 of the Standard Access Agreement for the Surplus Access Rights for the Train Service Type.</p>
Scheduled Train Path	<p>For a Timetabled Traffic, the entitlement of an Access Holder, as identified in its Train Service Entitlement, to use a specified portion of the Rail Infrastructure at the times and between the locations specified in the relevant MTP or Capability Train Plan referred to in clause 3A of Schedule G, so as to allow the passage of one Train.</p>
Second Year Allowable Revenue	<p>The meaning given to that term in clause 4.4(a)(i) of Schedule F.</p>
Segment	<p>Each segment of the Expansion specified as such in the Train Description for the Conditional Access Rights in the relevant Access Agreement which are conditional upon the completion and commissioning of the Expansion.</p>
Self-Insurance	<p>Any funds set aside by Aurizon Network for the purpose of allowing Aurizon Network to manage its own financial risks, including all claims that may be made against Aurizon Network or its relevant Access Holders for which Aurizon Network self-insures.</p>
Senior AN Employee	<p>For the purposes of Part 3:</p> <ul style="list-style-type: none"> (a) the Group Executive of Aurizon Network (or equivalent); and (b) any direct reports of the Group Executive of Aurizon Network (or equivalent).
Senior Related Competitor Employee	<p>For the purposes of Part 3:</p> <ul style="list-style-type: none"> (a) the Group Executive of the Related Competitor (or equivalent); and (b) any direct reports of the Group Executive of the Related Competitor (or equivalent).

Senior Related Operator Employee	<p>For the purposes of Part 3:</p> <p>(a) the Group Executive of the Related Operator (or equivalent); and</p> <p>(b) any direct reports of the Group Executive of the Related Operator (or equivalent).</p>
Short Term Transfer	The meaning given to that term in clause 7.4.1(d)(ii) .
Significant Electric Investment	<p>All capital projects for a Year for the:</p> <p>(i) enhancement (including by way of the replacement of life-expired, obsolete, less efficient, lost, damaged or destroyed infrastructure); or</p> <p>(j) expansion,</p> <p>of electric Rail Infrastructure on the Goonyella System or Blackwater System, in either case, where the aggregate anticipated costs are more than \$20 million in the applicable Coal System.</p>
Socialisation	The full or partial aggregation of the Expansion Costs of a new Expansion with the costs associated with one or more existing Reference Tariffs for the same Coal System in order to determine a common Reference Tariff.
Special Majority of End Users	<p>In respect of End Users with Access Rights in:</p> <p>(a) where a Special Majority of End Users for a Coal System is required, the relevant Coal System; or</p> <p>(b) where a Special Majority of End Users generally is required, any Coal System</p> <p>(Voting End Users):</p> <p>(c) a number of Voting End Users that in aggregate hold at least 75% of the End User Voting Rights (Coal System) or End User Voting Rights (Network) (as applicable) held by the Voting End Users for the Year; and</p> <p>(d) at least 60% of Voting End Users by number at the relevant time.</p>

Stand Alone Costs	<p>Those costs that Aurizon Network would incur if the relevant Train Service(s) was (were) the only Train Service(s) provided Access by Aurizon Network, where those costs are assessed:</p> <p>(a) as the Efficient Costs; and</p> <p>(b) on the basis of the assets reasonably required for the provision of Access,</p> <p>and includes an allowable rate of return expressed in nominal post tax terms (with the cost of debt expressed on a before tax basis), as agreed by Aurizon Network and the QCA or, failing such agreement, as determined by the QCA, and Stand Alone has a similar meaning.</p>
Standard Access Agreement	The standard form Access Agreement set out in Volume 3.
Standard Agreement	Any agreement that is in the form of a Standard Access Agreement, Revised Standard Rail Connection Agreement (if applicable), Standard Rail Connection Agreement, Standard Studies Funding Agreement or Standard Train Operations Deed.
Standard Rail Connection Agreement	The standard form of Rail Connection Agreement set out in Volume 3.
Standard Studies Funding Agreement	The standard form of Studies Funding Agreement set out in Volume 3.
Standard Train Operations Deed	The standard form of Train Operations Deed set out in Volume 3.
State	The State of Queensland.
Static Length	In respect of a Train, the length of that Train calculated as the aggregate of the lengths of each item of Rollingstock comprising or to comprise that Train (including the locomotive/s).
Stowage	<p>(a) Dwell; and</p> <p>(b) the short-term storage of Trains on the Rail Infrastructure at locations specified by Aurizon Network where an Access Holder cannot operate its Train Service in accordance with its Train Service Entitlement as the result of a breakdown or other temporary outage of the Access Holder, the loading facility or the unloading facility, and/or the unavailability of Rail Infrastructure, but does not</p>

include storage of individual items of Rollingstock or the long-term storage of Trains.

Studies Funding Agreement

In respect of a Pre-feasibility Study or a Feasibility Study, as applicable, an agreement with Aurizon Network in relation to the provision of funding to Aurizon Network for that Pre-feasibility Study or Feasibility Study.

Supply Chain

All aspects that affect the transportation of coal from a mine to the end customer, including loading facilities, Rail Infrastructure, Railway Operators, load out facilities and coal export terminal facilities. For clarity, a number of supply chains can exist within a Coal System and can be denoted by reference to the destination coal export terminal.

Supply Chain Coordination Entity

The meaning given to that term under **clause 7A.8.1(a)**.

Supply Chain Group

A group:

- (a) that has been established as a supply chain coordination group for the purpose of coordinating some or all aspects of the planning or operation of a Supply Chain;
- (b) which, other than in respect of the Hay Point Services Coal Terminal, has the support of sufficient participants in the Supply Chain to effectively perform that coordination purpose; and
- (c) which includes consideration of the service taken to be declared under section 250(1)(a) of the Act.

Supply Chain Master Plan

An integrated plan identifying feasible investment options for increasing the capacity of a Supply Chain (including variations to Supply Chain operating assumptions for the Supply Chain) and evaluating those investment options from a total cost, risk and timing perspective.

Supply Chain Participants

All participants in a Supply Chain including Access Holders, Customers, Railway Operators, port operators and Aurizon Network.

Supply Chain Proposal

The meaning given to that term under **clause 7A.8.1(a)**.

Supply Chain Rights

The following rights:

- (a) where any Supply Chain infrastructure is required to be accessed or used to operate Train Services, rights on the Rail Infrastructure;

- (b) in respect of Train Services that will operate on Supply Chain infrastructure prior to entering and/or after exiting the Rail Infrastructure as part of its journey, rights which are sufficient to allow the Train Services to enter or exit (as applicable) the Rail Infrastructure from or to (as applicable) that Private Infrastructure; and
 - (c) if the Train Services are to be operated to an unloading facility or loading facility, rights which are sufficient to allow:
 - (i) in relation to an unloading facility:
 - (A) access to the relevant unloading facility with a fully loaded Train which complies with the proposed Train Service Entitlement for the Train Services; and
 - (B) the unloading of all coal from the Train at the relevant unloading facility; and
 - (ii) in relation to a loading facility:
 - (A) access to the relevant loading facility with a Train which complies with the proposed Train Service Entitlement for the Train Services; and
 - (B) the loading of coal onto the Train at the relevant unloading facility,
- assuming, in either case, 100% utilisation of the Access Rights for the relevant Train Services in accordance with the proposed Train Service Entitlement.

Surplus Access Rights	Has the meaning given to that term in the Standard Access Agreement.
Suspension Period	The meaning given to that term in clause 4.5(k) .
System Capacity	The meaning given to that term in clause 7A.2(b) .
System Capacity Assessment	An assessment undertaken under clause 7A.4.3 .
System Discount	The amount specified as such, in Schedule F , for the relevant Reference Train Service.
System Forecast	The gtk forecast for the relevant Coal System that is specified in Schedule F .

System Operating Parameters	<p>(a) At any time prior to the Initial Capacity Assessment Report being published on the QCA's website, Aurizon Network's assumptions on the operation of each element of the coal Supply Chain and the interfaces between those elements including in relation to the Supply Chain operating mode, seasonal variations and live run losses, as published on its Website from time to time; and.</p> <p>(b) thereafter, the assumptions referred to in paragraph (a) of this definition as updated by the Independent Expert and as published on the QCA website from time to time.</p>
System Path	A path that can be taken by a Train Service from a specific origin to a Nominated Unloading Facility.
System Premium	The amount specified as such, in Schedule F , for the relevant Reference Train Service.
System Reference Tariff	The tariffs set out in clauses 7, 8, 9, 10 and 11 of Schedule F for a specified Reference Train Service in relation to a Coal System (as amended, varied or escalated in accordance with this Undertaking or the Act from time to time).
System Rules	<p>Rules specifying the way in which Aurizon Network will plan, schedule and control the operation of Train Services on a one or combination of Coal Systems:</p> <p>(a) which:</p> <ul style="list-style-type: none"> (i) are approved for a Coal System under clause 7A.7.5; or (ii) existed under the 2016 Undertaking immediately prior to the Approval Date, as amended from time to time under clause 7A.7.4; and <p>(b) which may include, for example:</p> <ul style="list-style-type: none"> (i) the declaration of System Paths for a Coal System; (ii) the procedures for Access Holders to submit Train Orders and for Aurizon Network to schedule Train Services in the ITP; (iii) the procedures for Aurizon Network to schedule the DTP from the ITP, provided that these procedures must be consistent with the

	<p>matters referred to in clauses 5.2 and 5.4(c) of Schedule G;</p> <p>(iv) the relevant critical objectives for Train Services operating in one or a combination of Coal Systems to assist decision-making for Network Control under clause 7 of Schedule G;</p> <p>(v) a methodology for defining path availability/use for the purpose of calculating TOP Charges; and</p> <p>(vi) the identification of any circumstances where an Initial Capacity Analysis or Capacity Analysis is not required for the purposes of clause 4.6(c) or clause 4.11.2(a)(v).</p>
Take or Pay	A charge payable to Aurizon Network in circumstances where contracted Train Services are not operated by or for the relevant Access Holder. For a Reference Tariff, the Take or Pay requirements and calculations are set out in clause 3 of Schedule F .
Target Capacity	The meaning given to that term in clause 8.3.3(b) .
Tariff Based Access Agreement	In relation to a Reference Tariff, an Access Agreement to the extent that the Access Charges under that Access Agreement are set by reference to that Reference Tariff.
Tariff Take or Pay	Take or Pay in relation to Train Service Entitlements for which Access Charges are set by reference to the same Reference Tariff.
Tax Allowance	An allowance to compensate Aurizon Network for tax expense as outlined within Section 1.5 of the QCA's 2018 Decision and applying the rate for Gamma.
Term	The period between the Approval Date and the Terminating Date.
Terminating Date	<p>The earlier of:</p> <p>(a) 30 June 2027;</p> <p>(b) the end of the day on which the service to which this Undertaking relates, ceases to be taken to be a service declared for the purposes of Part 5 of the Act but only where the relevant Minister has not made a declaration as referred to in clause 12.5 of this Undertaking; and</p> <p>(c) the date on which this Undertaking is withdrawn in accordance with the Act.</p>

Third Party	A person other than an Aurizon Party.
Third Party Access Seeker	A Third Party which is an Access Seeker and, for the purposes of Part 3 , includes a Third Party who wants Access, or increased Access whether or not an Access Application has been lodged.
TIA	Transport Infrastructure Act 1994 (Qld).
Timetabled Traffic	A traffic, the Train Service Entitlement in respect of which, is defined in terms of a specified Train Path on a particular day and/or week (but excluding any traffic that is a coal carrying Train Service).
TOP Charges	The charge for contracted Train Services where the contracted Train Services are not operated by, or by a Railway Operator for, the relevant Access Holder under the relevant Access Agreement and is the amount determined under clause 3.2 and 3.3 of Schedule F .
Total Actual Revenue	<p>(a) For AT₂₋₄ in relation to a Coal System, the amount calculated in accordance with clauses 4.3(d) to (i) of Schedule F; and</p> <p>(b) for the AT₅ component of Access Charges in relation to a Coal System, the amount calculated in accordance with clauses 4.3(j) to (k) of Schedule F.</p>
Track	That part of the Rail Infrastructure comprising the rail, ballast, sleepers and associated fittings.
Track Segment	A part of the Rail Infrastructure comprising a rail corridor shown as a specified "Track Segment" as shown in the Preliminary Information including all branch lines directly connecting coal mine loading facilities to that "Track Segment".
Train	Any configuration of Rollingstock operating as a unit on Track.
Train Description	The meaning given to that term in the relevant Access Agreement.
Train Movement	Any operation of a Train on the Rail Infrastructure by a Train Operator or any other Railway Operator.
Train Operations Deed	A train operations deed or agreement agreed (or otherwise entered into) between Aurizon Network and the relevant Train Operator under which the Train Operator is nominated by an Access Holder to operate Train Services for that Access Holder (including under a Train Operations Deed entered into under clause 5.3).

Train Operator	A person nominated by an Access Seeker or an Access Holder to operate Train Services for that Access Seeker or Access Holder under the terms of a Train Operations Deed.
Train Orders	Railing requests for a nominated period of time submitted to Aurizon Network, by or on behalf of an Access Holder or a Train Operator, after taking into account any restrictions on or unavailability of loading or unloading facilities, Private Infrastructure, Rollingstock or other Above Rail Services, to assist in the scheduling of Train Services.
Train Path	The occupation of a specified portion of Rail Infrastructure, which may include multiple sections in sequential order, for a specified time.
Train Service	A Train operating on the Rail Infrastructure from a specified origin to a specified destination.
Train Service Change	<p>A change to:</p> <p>(a) for Timetabled Traffic, the time or times at which; or</p> <p>(b) for Cyclic Traffic, the Train Path or Train Paths for which,</p> <p>one or more Train Services are planned or scheduled to operate, as applicable, (and not the other terms under which a person has an entitlement to run those Train Services, for example, the Rollingstock or Rollingstock Configuration for those Train Services or the Rail Infrastructure on which those Train Services may operate).</p>
Train Service Commitment Date	The date specified as such for a Train Service Type in the relevant Access Agreement.
Train Service Entitlement	An Access Holder's entitlement pursuant to an Access Agreement to operate or cause to be operated a specified number and type of Train Services over the Rail Infrastructure including within a specified time period, in accordance with specified scheduling constraints and for the purpose of either carrying a specified commodity or providing a specified transport service.
Train Service Type	In respect of an Access Holder, a 'Train Service Type' as defined in that Access Holder's Access Agreement.
Transfer	<p>(a) For the purposes of Part 3 only, employ, second or engage on a contract for service basis, on a permanent or temporary basis.</p> <p>(b) In all other circumstances, the meaning given to that term in clause 7.4.1(d).</p>

Transfer Cancellation Notice	The meaning given to that term in clause 7.4.6(e) .
Transfer Date	The meaning given to that term in clause 7.4.2(a)(i) .
Transfer Fee	An amount payable to Aurizon Network under clause 7.4.6.
Transfer Notice	The meaning given to that term in clause 7.4.2(a) .
Transfer Period	The period commencing on the Transfer Date and ending on the date on which the transfer of the Nominated Access Rights is terminated (if any).
Transferee	The meaning given to that term in clause 7.4.1(b) .
Transferor	The meaning given to that term in clause 7.4.1(b) .
Transferred Access Rights	The meaning given to that term in clause 7.4.2(a)(iii) .
Transitional Arrangements	The meaning given to that term in clause 7A.5(a)(ii).
Transmission Entities	The meaning given to that term in the <i>Electricity Act 1994</i> (Qld).
TUOS Charge	The transmission use of system charge payable by Aurizon Network as part of its connection costs.
Ultimate Holding Company	The holding company (as defined in the Corporations Act) of Aurizon Network, which is the ultimate owner of Aurizon Network – being as at the Approval Date, Aurizon Holdings.
Ultimate Holding Company Support Deed	The deed required under clause 2.5(a) .
Unallocated Delay	A delay to a Train Service from its Train Path scheduled in the DTP that is neither an Above Rail Delay nor a Below Rail Delay.
Undertaking	This document (including all volumes and schedules) which is an access undertaking for the purposes of the Act.
Unexpended Portion	The meaning given to that term under clause 8.2.1(b)(ii)(B) .
Unloading Time	The time between a Train Service arriving at a Nominated Unloading Facility and that same Train departing the Nominated Unloading Facility, and for the purpose of clarity, this time runs from when a Train Service arrives at the entry signal to the Nominated Unloading Facility until it has completed unloading, presented at the exit signal, is ready to depart the Nominated Unloading Facility and has advised the relevant Network Controller accordingly.

Urgent Possession	<p>A Possession:</p> <ul style="list-style-type: none"> (a) required to correct problems that Aurizon Network (acting reasonably) considers potentially dangerous to any person, or property; (b) notified to Access Holders less than twenty-one (21) days in advance of taking effect; and (c) that Aurizon Network, complying with the Possession Protocols, will use reasonable endeavours to carry out between seven (7) days and three (3) Months after the detection of the fault giving rise to the need for that Possession.
User Funded Expansion	An Expansion that is funded wholly or partly by Expansion Funders under a User Funding Agreement.
User Funding	The provision of funding to Aurizon Network by an Expansion Funder (including indirectly through a third party) in accordance with a User Funding Agreement.
User Funding Agreement	An agreement, or a number of related agreements, to which Aurizon Network is a party under which, among other things, Access Seekers (and/or their Customers) agree to provide funding for the construction of an Expansion .
User Funding Trust	The trust established under a User Funding Agreement.
User Funding Trustee	An entity that is the trustee of a User Funding Trust.
Users	Access Seekers, Access Holders and/or their Customers (if any).
Variable Connection Charge	Any variable charges associated with the connection of Aurizon Network's electrical traction system to an electricity transmission or distribution network billed on an energy consumed basis as approved each year by the QCA under clause 2.2(a) of Schedule F .
Variations	The meaning given to that term under clause 7A.7.4(e)(iii)(C) .
Varied WACC	A weighted average cost of capital different to that of the Approved WACC.
Volume Risk	The meaning given to that term in clause 6.4.4(a)(iv) .
Website	www.aurizon.com.au .
Working Capital Allowance	An allowance to compensate Aurizon Network for cash flow timing differences as outlined within Section 1.4 of the QCA's 2018 Decision.

Voting End Users	The meaning given in the definition of 'Audit Majority of End Users', 'Majority of End Users' or 'Special Majority of End Users', as applicable.
Yard Control	The control of Train Movements and other activities affecting Train Movements at those locations that are not under the direct control of a Network Controller.
Year	A period of twelve (12) Months commencing 1 July.

12.2 Interpretation

- (a) Unless expressed to the contrary, in this Undertaking:
- (i) a reference to:
- (A) a specified position name is a reference to that position name as it changes during the Term, provided that the position retains responsibility for the same or substantially the same tasks;
 - (B) a person includes a partnership, an unincorporated joint venture, an unincorporated association, a corporation, a government or statutory body or authority and any other entity recognised by law;
 - (C) 'dollars' or '\$' means a reference to Australian dollars;
 - (D) any parties by their defined terms includes that party's executors, administrators, permitted assigns or permitted subcontractors or, being a company, its successors, permitted assigns or permitted subcontractors and the obligation of any party extends to those persons;
 - (E) a right includes a benefit, remedy, discretion, authority or power;
 - (F) conduct includes any omission and any representation, statement or undertaking, whether or not in writing;
 - (G) 'includes' means includes without limitation;
 - (H) time is to local time in Brisbane, Queensland;
 - (I) this or any other document or agreement includes the document or agreement as varied, amended or replaced from time to time;
 - (J) any legislation includes subordinate legislation under it and includes that legislation and subordinate legislation as modified or replaced, amended, consolidated, re-enacted or codified;

- (K) this Undertaking includes this Undertaking as amended from time to time in accordance with the Act or this Undertaking;
 - (L) an input of a Reference Tariff or an Access Charge is reference to each amount that is a tariff or input which is applied in the calculation for that Reference Tariff or Access Charge – for example, the amounts for AT₁, AT₂, AT₃, AT₄, AT₅, EC, the QCA Levy and the IE Fee specified in **clauses 7.2, 8.2, 9.2, 10.2 and 11.2 of Schedule F**, as applicable for each Reference Tariff, are each inputs for the Reference Tariff; and
 - (M) a component of a Reference Tariff or an Access Charge is a reference to each sub-calculation for that Reference Tariff or Access Charge that involves an input being multiplied by an applicable multiplier – for example, in the formula under **clause 2.2(a) of Schedule F** each individual bracketed calculation comprised in that formula is a separate component of the Reference Tariff;
- (ii) words importing the singular number includes the plural number and vice versa;
 - (iii) words importing any gender include the other gender;
 - (iv) where a word or phrase is defined, its other grammatical forms have a corresponding meaning;
 - (v) clause headings are for reference purposes only and do not affect the interpretation of this Undertaking;
 - (vi) where:
 - (A) a group of persons are in a partnership, an unincorporated joint venture, an unincorporated association or other similar arrangement; and
 - (B) that group of persons together execute or seek to execute an agreement (including an Access Agreement or a rail haulage agreement) or such an agreement is executed or is sought to be executed for or on behalf of that group of persons,
 then:
 - (C) that group of persons is deemed to constitute a single person, Customer, Access Seeker or Access Holder (as applicable); and
 - (D) where a notification required to be given under this Undertaking is given by one member of that group

of persons it will be deemed to have been given on behalf of all members of that group persons;

- (vii) every agreement or undertaking expressed or implied by which more than one person agrees or undertakes any obligations or derives any benefit binds or ensures for the benefit of those persons jointly and each of them severally;
 - (viii) subject to **clause 12.2(a)(ix)**, a reference to:
 - (A) a part or clause is a reference to the corresponding part or clause found in **Part 1 to Part 12** of this Undertaking;
 - (B) a volume is a reference to the corresponding volume of this Undertaking; or
 - (C) a schedule is a reference to the corresponding schedule to this Undertaking,as amended or replaced from time to time;
 - (ix) in a schedule to this Undertaking, a reference to:
 - (A) a part or clause, is a reference to a part or clause of that schedule unless otherwise stated; and
 - (B) a part or clause of this Undertaking, is a reference to a part or clause found in **Part 1 to Part 12** of this Undertaking; and
 - (x) Subject to **clause 12.2(b)**, if there is any inconsistency between matters contained in a schedule and **Part 1 to Part 12** of this Undertaking, the provisions in **Part 1 to Part 12** of this Undertaking prevail.
- (b) A term that is used in this Undertaking but not defined in this **Part 12** and which is defined in a Standard Access Agreement, will have the meaning given to that term in the Standard Access Agreement.
 - (c) Where a provision of this Undertaking refers to the Access Rights held by an End User, the Access Rights held by the End User will be taken to be:
 - (i) if the End User is an Access Holder (other than an Access Holder that holds Access Rights for the purpose of providing Train Services for a Customer), the Access Rights held by that Access Holder; and
 - (ii) if the End User is a Customer, the Access Rights held by each relevant Access Holder for the purpose of providing Train Services for that Customer.
 - (d) Where a provision of this Undertaking includes a reference to preventing or hindering an Access Seeker's or Access Holder's Access:

- (i) that reference is solely a reflection of Aurizon Network's obligations under sections 104 and 125 of the Act (as applicable) and does not expand those obligations; and
 - (ii) must be given the same meaning as in sections 104 and 125 of the Act (as applicable).
- (e) To the extent that Aurizon Network's obligations under this Undertaking are or become inconsistent with Aurizon Network's obligations under any Law, this Undertaking does not apply to the extent of that inconsistency.
- (f) If this Undertaking obliges Aurizon Network to provide any information, reports, documents or other material (in whatever form) (**Information**) to the QCA or any other person (including an Auditor) then, despite any other provision in this Undertaking, Aurizon Network is not required to comply with that obligation if Aurizon Network claims:
- (i) on the ground of self-incrimination a privilege Aurizon Network would be entitled to claim against providing the Information were Aurizon Network a witness in a prosecution for an offence in the Supreme Court of Queensland; or
 - (ii) that legal professional privilege applies in respect of that Information.
- But if Aurizon Network does not comply with an obligation on that basis, Aurizon Network must notify the QCA of this and Aurizon Network or the QCA may apply to the Supreme Court of Queensland for a determination of the validity of such a claim of privilege.
- (g) Despite any other provision in this Undertaking, this Undertaking does not expressly or impliedly waive any claim that Aurizon Network may have to legal professional privilege in respect of any information, reports, documents or other material (in whatever form).
- (h) A reference to the 'members of the Rail Industry Group' is a reference to a members of the Rail Industry Group as notified by the Chair of the Rail Industry Group to Aurizon Network from time to time.

12.3 Notices

- (a) A notice, consent, approval, undertaking or any other communication or document (**Notice**) connected with this Undertaking has no legal effect unless it is in writing.
- (b) Where this Undertaking requires a Notice be given to a person, the Notice may, in addition to any other lawful means be given by being hand delivered, sent by pre-paid post, facsimile or, if agreed by Aurizon Network, email.

- (c) Unless a later time is specified in it, any Notice takes effect and, subject to **clause 12.3(d)**, is given from the earlier of the time it is actually given or is taken to be given.
- (d) A Notice is taken to be given, in the case of a Notice given by:
 - (i) hand delivery, at the time of delivery;
 - (ii) post:
 - (A) three Business Days after the date of posting – if posted within Australia to an Australian address; and
 - (B) 10 Business Days after the date of posting – in any other case;
 - (iii) facsimile, on the sender's facsimile machine producing a transmission report indicating that the facsimile was sent in full to the facsimile number of the addressee (and that report is conclusive evidence that the addressee received the facsimile in full at the time indicated on that report); and
 - (iv) email, on the next Business Day after being sent (as recorded on the device from which the sender sent the email) unless the sender receives an automated message that the email has not been delivered.
- (e) If a Notice is given:
 - (i) after 5:00 pm in the place of receipt; or
 - (ii) on a day which is not a Business Day in the place of receipt,
 it is taken as having been given at 9:00 am on the next Business Day in the place of receipt.

12.4 Transitional

- (a) All acts, applications, approvals, approval processes, arrangements, circumstances, conduct, decisions, determinations, dispute resolution processes, events, Force Majeure Events, matters, negotiations, notices, omissions, queues, registers, requests, time periods, votes, warranties or any other process or thing whatsoever (**Matter**) done, agreed, arising, given, received, undertaken, commenced or established (**Done**) or deemed to be Done under the 2016 Undertaking are deemed to be Done and, as applicable, continue under this Undertaking as though the Matter was Done under this Undertaking to the extent that this Undertaking provides for equivalent Matters to be Done.
- (b) For the purposes of this Undertaking, the date of execution for an Access Agreement executed in accordance with Subparagraph 2.5.2(f) of the 2008 Undertaking is deemed to be the date when the Internal Access Agreement (as defined under the 2008 Undertaking) it replaced was put in place.

- (c) If this Undertaking requires Aurizon Network to report to the QCA on a Quarter or a Year that began prior to the Approval Date, then:
 - (i) the relevant report will include information in respect of the period prior to the Approval Date; and
 - (ii) Aurizon Network is only obliged to provide information for the period prior to the Approval Date as would have been required to be provided under the 2016 Undertaking in respect of that same type of report.
- (d) If the Approval Date is not the first day of a Year, then this Undertaking will apply in respect of any calculation of Revenue Adjustment Amounts, adjustments to Second Year Allowable Revenue and other relevant revenue cap calculations in relation to the whole of the Year within which the Approval Date falls.
- (e) If the Approval Date occurs prior to the calculation of Revenue Adjustment Amounts, adjustments to Second Year Allowable Revenue and other revenue cap calculations for the preceding Year being undertaken and submitted to the QCA for approval, then those calculations may still be undertaken, and submitted to the QCA, by Aurizon Network as though the provisions under the 2016 Undertaking still applied in respect of those calculations and their approval by the QCA.
- (f) If a transitional matter is not otherwise dealt with under clauses **12.4(a) – (e)**, the QCA and Aurizon Network may agree in writing the arrangements that apply to manage the transition between the undertaking in place on the day immediately prior to the Approval Date and this Undertaking.

12.5 New declaration

If the service to which this Undertaking relates ceases to be taken to be declared under section 250(1)(a) of the Act, and, if the relevant Minister makes a declaration in relation to that service or part of the service which is itself a service, under Part 5 of the Act which is to start with effect from the expiry date referred to in section 87A(1) of the Act, then, from that date:

- (a) subject to **paragraph (c)** below, this Undertaking will continue to apply to any service (or part thereof) which was originally declared by section 250(1)(a) of the Act and which service (or part thereof) is later declared by the Minister under Part 5 of the Act;
- (b) subject to paragraph **(c)** below, any reference in this Undertaking to “service taken to be declared under section 250(1)(a) of the Act” (and words having similar effect) will be taken to also refer to a service to which this Undertaking continues to apply pursuant to **paragraph (a)** above;

- (c) **paragraphs (a) and (b)** above apply only where the declaration by the Minister under Part 5 of the Act takes effect from the expiry date (referred to in section 87A(1) of the Act) of the declaration under section 250(1)(a) of the Act.

12.6 End User DAAU

- (a) This **clause 12.6** applies where:
- (i) a material change in circumstances within the meaning of **clause 12.6(b)** occurs after the Approval Date;
 - (ii) that material change in circumstances results in or will result in a material adverse impact on more than one End User;
 - (iii) the material adverse impact relates to a matter that is properly the subject of an access undertaking;
 - (iv) a draft amending access undertaking is prepared by or on behalf of an End User or End Users which addresses the relevant material adverse impact and is otherwise on the terms of this Undertaking (**End User DAAU**);
 - (v) the End User DAAU does not change:
 - (A) the WACC and any of the matters referred to in **Part 6A**;
 - (B) the mechanism for calculating any rebate payable by Aurizon Network to Access Holders and Customers in relation to the non-provision of Train Service Entitlements;
 - (C) the process for determining operation and maintenance costs;
 - (D) Aurizon Network's obligation to fund Expansions;
 - (E) the duration of the Undertaking;
 - (F) the process described in **clause 7A.8.1** (Proposal for Supply Chain Coordination Entity); or
 - (G) **Part 11** (Dispute Resolution and Decision Making);
 - (vi) the End User DAAU, and details of the material change in circumstance and the actual or reasonably likely material adverse impact that the End User DAAU intends to address have been provided to Aurizon Network and all affected End Users;
 - (vii) no earlier than 60 days following the provision of the information referred to in **clause 12.6(a)(vi)**, a vote is called by the party responsible for the preparation of the End User DAAU for all End Users (across all Coal Systems) for the submission of the proposed End User DAAU to the QCA;

- (viii) a Special Majority of End Users vote in favour of the submission of the End User DAAU to the QCA; and
 - (ix) Aurizon Network has been notified in writing of the outcome of the vote set out in **clause 12.6(a)(vii)** and the process by which it was conducted.
- (b) A material change in circumstances will only occur if:
 - (i) it relates to an actual change in the circumstances that existed as at the Approval Date; and
 - (ii) the change in circumstances was not known or expressly contemplated by the parties in the negotiations for, or express terms of, this Undertaking.
- (c) Where each of the circumstances in **clause 12.6(a)** have been met, Aurizon Network must submit any End User DAAU approved by a Special Majority of End Users under **clause 12.6(a)(viii)** for consideration by the QCA in accordance with section 142 of the Act. In making such a submission Aurizon Network must confirm to the QCA that Aurizon Network does not have an objection to the QCA considering and making a decision in respect of the End User DAAU, but is not required to support the substance of the End User DAAU.

Schedule A

Preliminary, Additional and Capacity Information

1 Preliminary Information

The following preliminary information will be made available on the Website for Access Seekers:

- (a) **(Introduction)** The criteria for the use of data and the purpose of the preliminary information.
- (b) **(Civil Infrastructure)** A description of the railway and Track and any operational constraints, e.g. grades and curves.
- (c) **(Telecommunications)** A description of the communication system used.
- (d) **(Electric Traction)** A general system description.
- (e) **(Interface Requirements)** Information on track gauge, axle loads, train speeds, Rollingstock gauge and noise limits.
- (f) **(Locality Information)** Terrain information and climatic conditions and resultant system disruptions.
- (g) **(Committed Corridor Upgrades)** Identification of any relevant committed corridor upgrades.
- (h) **(Maps and Drawings)** Corridor maps and Line Diagrams including plans specifying Track Segments and Mainline Paths.
- (i) **(Level Crossings)** The number of public and occupational level crossings and the type of protection used.
- (j) **(Train Operations)** Sectional running times (calculated based on the projected average sectional running times), maximum Train lengths incident recovery times, crew change locations and facilities forming part of the Rail Infrastructure² and stowage infrastructure locations.
- (k) **(Systems)** A description of operational, safeworking and signalling systems.
- (l) **(Rollingstock Interface Standards)** A copy of the relevant Rollingstock Interface Standards.
- (m) **(Description of entitlements)** Information relating to the description of, and calculations in respect of, Train Service Entitlements and Capacity.

² For example, safety matting next to Track to help people safely walk on the ballast.

- (n) **(Commercial Information)** The applicable Reference Tariffs and Standard Access Agreement and System Rules together with a sample IRMP listing Interface Risks and Environmental Risks that should, at a minimum, be addressed during an Interface Risk Assessment, along with suggested control measures that are at least industry standard or otherwise required by Aurizon Network's accreditation requirements under the Rail Safety Act.

However, the sample IRMP is not exhaustive of the matters that should be considered as part of an Interface Risk Assessment. An IRMP may set out additional or different matters depending on the circumstances (including additional safety and/or Rollingstock issues and associated controls) as long as those additional matters are industry standard or otherwise required by Aurizon Network's accreditation requirements under the Rail Safety Act.

2 Additional Information

For the purpose of **clause 4.11.2(a)(ii)** of this Undertaking, Aurizon Network is required to provide the following information to an Access Seeker:

<p>Access to rail corridor</p>	<p>Where Aurizon Network does not have authority to authorise the Access Seeker to access land on which Rail Infrastructure on a route nominated by the Access Seeker is situated, the following information in relation to access to that land:</p> <ul style="list-style-type: none"> (a) the name, address and contact details of the person (Landholder) that the Access Seeker needs approval from to access that land, where this information is reasonably available to Aurizon Network without breaching its confidentiality obligations under this Undertaking, an Access Agreement or any lease, licence or other agreement with the Landholder; (b) advice as to the nature and extent of the rights, if any, that Aurizon Network holds in relation to the relevant land without breaching its confidentiality obligations under this Undertaking, an Access Agreement or any lease, licence or other agreement with the Landholder; and (c) a notice that may be provided to that person indicating that Aurizon Network has no objection to the Access Seeker negotiating for access to that land.
--------------------------------	--

Compliance information	Subject to the Access Seeker having entered into an applicable confidentiality agreement with Aurizon Network, the protocols, standards and procedures an Access Holder is required to comply with under the terms of the relevant Standard Access Agreement.
Other information	<p>(a) Information required under section 101(2) of the Act, to the extent not already provided.</p> <p>(b) Other information that is reasonably required by the Access Seeker in accordance with Aurizon Network's obligation under section 101(1) of the Act, provided such information cannot reasonably be obtained from another source.</p>

3 Capacity Information

- (a) This **clause 3** only applies in respect of information which can be provided by Aurizon Network without breaching either Aurizon Network's obligations under **Part 3** of this Undertaking, an Access Agreement or any relevant confidentiality agreement.
- (b) In addition to the Preliminary Information and the Additional Information, the Daily Train Plan (as assessed under **clause 3(c)** for the relevant part of the Rail Infrastructure) will be provided to an Access Seeker by Aurizon Network on request by that Access Seeker subject to:
- (i) the identity of other Access Holders not being detailed; and
 - (ii) the terms of other Access Holders' Train Service Entitlements not being detailed.

In addition, the Intermediate Train Plan and the Daily Train Plan may not show all parts of the Rail Infrastructure, and as such may not show all Train Services that may impact on the Existing Capacity detailed. However, Aurizon Network will note those other parts of the Rail Infrastructure where interaction with other Train Services is most likely to impact on the Existing Capacity detailed.

- (c) The relevant current Daily Train Plan will be assessed as, for an Access Application in respect of:
- (i) a Timetabled Traffic, the current Daily Train Plan for the relevant day (or days) of the week; or
 - (ii) a Cyclic Traffic, the current Daily Train Plans for a week, unless Aurizon Network reasonably believes that provision of Daily Train Plans for a longer period of time is required in order that the Daily Train Plans show a use of Existing Capacity that is representative of current utilisation.

- (d) Aurizon Network will also provide access to Network Control diagrams, indicating actual running of Train Services against the relevant Daily Train Plan, for those days for which the Daily Train Plan has been provided under **clause 3(b)**.

Schedule B

Access Application information requirements

1 Application

- (a) Without limiting the information requirements that an Access Application must satisfy in accordance with this Undertaking, an Access Application must satisfy the information requirements set out in this **Schedule B**.
- (b) This **Schedule B** applies as follows:
 - (i) where the proposed Access Application is solely for a Transfer in respect of Transferred Access Rights, **clause 6** applies (and, except as expressly referred to in **clause 6**, **clauses 2 to 5** and **clause 7** do not apply);
 - (ii) where the proposed Access Application is solely for a Renewal, **clause 7** applies (and, except as expressly referred to in **clause 7**, **clauses 2 to 6** do not apply); and
 - (iii) subject to **clauses 1(b)(i)** and **(ii)**, for all other proposed Access Applications, **clauses 2 to 5** apply.

2 Access Seeker and Customer

Relevant contact details including:

- (a) the Access Seeker's name and contact details;
- (b) if the Access Seeker has a Customer (or prospective Customer), that Customer's (or prospective Customer's) name and contact details; and
- (c) if the Access Seeker or its Customer (or prospective Customer) is an unincorporated joint venture, the names and contact details for all joint venture participants.

3 Ability to use Access Rights

Information needed to assess matters referred to in **clause 4.13(c)** of this Undertaking, including the following information about matters to be taken in account under **clause 4.13(c)** of this Undertaking:

- (a) where an Access Seeker is seeking Access Rights that will be used for a person other than the Access Seeker (that is, a person who is the Access Seeker's Customer or prospective Customer), the identity of the Customer or prospective Customer for those Access Rights are sought is to be confirmed along with information evidencing that the Access Seeker has or is reasonably likely to have such a Customer,

and that the Customer or prospective Customer has authorised the Access Seeker to apply for the relevant Access Rights. Aurizon Network will disregard for this purpose the effect that granting the Access Rights to the Access Seeker will have on the Access Seeker's ability to attract a Customer in the future;

- (b) for a Train Operator, the identity of the relevant Access Seeker or Access Holder for whom they are the Train Operator;
- (c) whether the Access Seeker has secured, or is reasonably likely to secure, Supply Chain Rights;
- (d) whether the Access Seeker, or its Customer (if any), has secured or is reasonably likely to secure a rail haulage agreement for the operation of the proposed Train Services within the timeframes and in the manner contemplated by the Access Application, if applicable;
- (e) whether the Access Seeker or its Railway Operator is reasonably likely to have facilities (including Rollingstock, provisioning facilities, maintenance facilities and storage facilities) to enable it to run Train Services to fully utilise the Access Rights sought;
- (f) where the Access Rights are sought to transport the output of a mine, whether the anticipated output of the mine is sufficient to support full utilisation of the Access Rights sought and all relevant existing Access Rights relevant to that mine; and
- (g) where the Access Rights sought require a Customer Specific Branch Line for the relevant Train Services, whether the Customer Specific Branch Line has been constructed and commissioned or is reasonably likely to be constructed and commissioned prior to the date on which the relevant Train Services are to commence.

4 Coal and freight Train Services

4.1 Train Service description

Information describing the Train Services, including:

- (a) the route of operation (including a diagram if necessary) including origin, destination, loading facility, unloading facility and depot;
- (b) the proposed commencement date for Train Services;
- (c) the proposed term of the Access Agreement;
- (d) the method of transporting freight (e.g. containers, louvered wagons, bulk wagons);
- (e) a description of freight/ commodity;
- (f) the Coal System(s) in which the Train Service will operate;
- (g) the net tonnes of product per annum each Year of operation, represented on a Monthly basis, or where Monthly railings are not even, the proposed distribution of the net tonnes;

- (h) the proposed sectional run times;
- (i) the proposed maximum Dwell times, time at loading facility, time at unloading facility and time at depot;
- (j) the proposed non-standard operating modes or methods (if applicable); and
- (k) the proposed Stowage requirements.

4.2 Timetable requirements

Information setting out the timetabling requirements, including:

- (a) whether the Access Rights sought are for a new Train Service, or a variation to an existing Train Service, for the Access Seeker;
- (b) whether the Access Rights sought are for a new Train Service or variation to an existing Train Service on the Rail Infrastructure;
- (c) the required frequency of Train Services, including weekly requirements, seasonality variations and any trends over the proposed Access Agreement term;
- (d) the preferred departure and arrival windows on preferred days of operation, separately for forward and return journeys, where relevant; and
- (e) the requirements for shunting or Dwell times en route, separately for forward and return journeys.

4.3 Rollingstock details

For all Access Seekers, information describing the Rollingstock and Rollingstock Configurations, including:

- (a) the proposed number of locomotives per Train;
- (b) the proposed number of wagons per Train;
- (c) the type and class of locomotive;
- (d) the mass of each locomotive (includes full sand and fuel load);
- (e) the type and class of wagons;
- (f) the nominal gross mass of wagons;
- (g) the tare mass of each wagon;
- (h) the tare mass per container;
- (i) the average number of containers per wagon;
- (j) the average proposed load (of product) per wagon;
- (k) the maximum proposed gross tonnes per wagon;
- (l) the maximum axle load of locomotives and wagons;
- (m) locomotive traction type;

- (n) where the traction type is electric traction, the regenerative braking capability and relevant details relating to that regenerative braking capability including electricity metering;
- (o) the gross tonnes per Train Service, separately for forward and return journeys;
- (p) the nominal payload per Train Service, separately for forward and return journeys; and
- (q) the Static Length and Comparative Length for the proposed Train.

4.4 Infrastructure requirements

Details of any Expansions or Customer Specific Branch Lines that may be necessary for operation of service, where known.

5 Passenger Train Services

5.1 Train Service description

Information describing the Train Services, including:

- (a) the route of operation (including a diagram, if necessary);
- (b) the proposed term of the Access Agreement; and
- (c) the type of passenger traffic (e.g. long distance, commuter, tourist).

5.2 Timetable requirements

Information setting out the timetabling requirements, including:

- (a) whether the Access Rights sought are for a new Train Service, or a variation to an existing Train Service, for the Access Seeker;
- (b) whether the Access Rights sought are for a new Train Service, or a variation to an existing Train Service, for the Rail Infrastructure;
- (c) the required frequency of Train Services, including weekly requirements, seasonality variations and any trends over the proposed Access Agreement term;
- (d) the preferred departure and arrival windows on preferred days of operation, separately for forward and return journeys; and
- (e) the requirements for shunting or Dwell times en route, separately for forward and return journeys.

5.3 Rollingstock details

Information describing the Rollingstock, including:

- (a) the total number of locomotives per Train;
- (b) the total number of carriages per Train;
- (c) the total number of passenger multiple units (**PMU**) per Train;
- (d) the type and class of locomotive;

- (e) the mass of each locomotive (including full sand and fuel load);
- (f) the type and class of carriage;
- (g) the nominal gross mass of each carriage;
- (h) the type and class of PMU;
- (i) the average gross mass of PMU;
- (j) the maximum number of vehicles including locomotives, wagons or units within PMU;
- (k) the maximum axle load of locomotives and wagons;
- (l) locomotive traction type;
- (m) the total length of Train (including locomotives);
- (n) the gross tonnes per Train Service, separately for forward and return journeys; and
- (o) the maximum operation speed separately for loaded and empty Trains.

5.4 Infrastructure requirements

Details of any Expansions or Customer Specific Branch Lines that may be necessary for operation of service, where known.

6 Transfers

Information relating to the Transfer including:

- (a) relevant contact details including:
 - (i) the Transferee's name and contact details;
 - (ii) if the Transferee has a Customer, that Customer's name and contact details;
 - (iii) if the Transferee or its Customer is an unincorporated joint venture, the names and contact details for all joint venture participants; and
 - (iv) the relevant Access Agreement (if applicable) held by the Transferee;
- (b) where the Transferee is not the current Access Holder (**Transferor**) who intends to undertake the relevant Transfer, relevant contact details for the Transferor including:
 - (i) the Transferor's name and contact details;
 - (ii) if the Transferor has a Customer, that Customer's name and contact details; and
 - (iii) if the Transferor or its Customer is an unincorporated joint venture, the names and contact details for all joint venture participants;

- (c) details identifying the Transferor's Access Agreement, and the Access Right under it (including by reference to origin and destination), to which the Transfer relates;
- (d) details referred to in **clause 3** with reference to the proposed Transfer;
- (e) the proposed date and term for the Transfer;
- (f) the information referred to in **clauses 3, 4.1 to 4.3** or **clauses 5.1 to 5.3** (as applicable);
- (g) evidence that the Transferor's Customer and the Transferee's Customer have been notified of, and have agreed to, the Transfer (except where the Transferor's Customer initiated the Transfer by notice to Aurizon Network); and
- (h) except to the extent that the Non-availability Circumstances exist, any other information that:
 - (i) it is necessary to provide under this Undertaking; or
 - (ii) is otherwise necessary and has been notified to the Access Seeker by Aurizon Network.

7 Renewals

Information relating to the Renewal including:

- (a) relevant contact details including:
 - (i) the Renewing Access Seeker's name and contact details;
 - (ii) if the Renewing Access Seeker has a Customer, that Customer's name and contact details; and
 - (iii) if the Renewing Access Seeker or its Customer is an unincorporated joint venture, the names and contact details for all joint venture participants;
- (b) where the Renewing Access Seeker is not the current Access Holder, relevant contact details for the current Access Holder including:
 - (i) the current Access Holder's name and contact details;
 - (ii) if the current Access Holder has a Customer, that Customer's name and contact details; and
 - (iii) if the current Access Holder or its Customer is an unincorporated joint venture, the names and contact details for all joint venture participants;
- (c) a description identifying the current Access Agreement to which the Renewal relates;
- (d) details referred to in **clause 3** with reference to the proposed Renewal;

- (e) whether the Renewal is for all or part of the relevant existing Access Rights and, where for part only, details of the relevant part;
- (f) details of all changes (if any) in:
 - (i) the information referred to in **clauses 3, 4.1 to 4.3** or **clauses 5.1 to 5.3** (as applicable)³; and
 - (ii) the Operating Plan,from that relating to the relevant existing Access Agreement.

³ A Renewal will not require any Expansion or Customer Specific Branch Line therefore **clauses 4.4** and **5.4**, as applicable, are not relevant.

Schedule C

Operating and other plan requirements

1 Operating Plan

- (a) The following matters must, amongst others, be included in an Operating Plan.
- (b) An Operating Plan will adopt a three tiered presentation of information with information for the following categories:
 - (i) whole of network information that applies generally to the Train Services of the Access Seeker or the Access Holder (see **clause 1.1**);
 - (ii) Coal System specific information that applies to the Train Services of the Access Seeker or the Access Holder operating in that Coal System (see **clause 1.2**) but was not provided under **clause 1.3**; and
 - (iii) origin/destination pair specific information that applies to the Train Services of the Access Seeker or Access Holder for that origin/destination pair (**clause 1.3**) but was not provided under **clauses 1.1** or **1.2**.

1.1 Umbrella Central Queensland Coal Network information

The following information must be provided in an Operating Plan on a whole of network basis.

Area of Operation	<ul style="list-style-type: none">• Depot locations
Operation	<ul style="list-style-type: none">• Type of service (passenger, freight) or commodity• Dangerous goods details• Overload management system• Stowage locations held by the operator• Timing of scheduled servicing/provisioning activities• The maximum Rollingstock operational speed separately for loaded and empty Trains
Train Information	<ul style="list-style-type: none">• Safety systems• Communication systems
Information in compliance with	<ul style="list-style-type: none">• Rollingstock Interface Standard

- | | |
|--------------------------------|---|
| standards and protocols | <ul style="list-style-type: none"> • Rollingstock and Rollingstock configuration details (number of wagons, locomotives, carriages/self-propelled units) • Overload management standard • Load tables (including loads for Train Services and all relevant requirements and information in relation to the specification of those loads) |
| Crewing Plan | <ul style="list-style-type: none"> • Train Service crew requirements: • Location of crew depots • Crew change points • Dwell times at change points (minimum and maximum) |
| Recovery Methods | <ul style="list-style-type: none"> • Recovery of marked off Rollingstock at loading/unloading locations/en route • Recovery of derailments • Recovery of failed locomotive |
| Environmental impacts | <ul style="list-style-type: none"> • Profiling and veneering |

1.2 Coal System specific information

- (a) The requirement for the information under this **clause 1.2** is in addition to **clause 1.1**.
- (b) The following information must be provided in an Operating Plan on Coal System basis, so that the information is provided separately for each relevant Coal System (as applicable).
- (c) For clarity, it is not necessary to repeat information already provided under **clause 1.1**.

- | | |
|--------------------------|--|
| Area of operation | <ul style="list-style-type: none"> • Origin and destination • Cycle description (including nominated stops en route) • Entry and exit points onto or off of Rail Infrastructure • Details regarding repositioning of Rollingstock (prior to, during and after operation of the Train Service) • Authority from Private Infrastructure manager to enter and/or exit the Private Infrastructure to enable use of Access Rights (where applicable) |
| Operation | <ul style="list-style-type: none"> • Description of any activities that may negatively impact main line running (e.g. shunting and reversing) • Dwell times at loading facility (minimum and maximum) |

- Dwell times at unloading facility (minimum and maximum)
 - Dwell times en route and operational requirements (minimum and maximum)
 - Indicative timetable requirements or sectional running times
- Train information**
- Type, class and number of locomotives per Train
 - Maximum and average gross tonnage of loaded Train (including locomotives)
 - Tare of empty Train
 - Method of operation
 - Traction type
 - Train length
 - Rollingstock and Rollingstock Configuration details (number of wagons/locomotives/carriages/self-propelled units)

1.3 Origin/destination pair specific information

- (a) The requirement for the information under this **clause 1.3** is in addition to **clauses 1.1** and **1.2**.
- (b) The following information must be provided in an Operating Plan on an origin/destination pair basis, so that the information is provided separately for each origin/destination pair of the relevant Train Services (as applicable).
- (c) For clarity, it is not necessary to repeat information already provided under **clauses 1.1** or **1.2**.

- Area of operation**
- Authority from Private Infrastructure manager to enter and/or exit the Private Infrastructure to enable use of Access Rights (where applicable)

- Operation**
- Special operating parameters (e.g. key arrival and departure windows)
 - Any critical timings at specified locations
 - Description of any activities that may negatively impact main line running (e.g. shunting and reversing)
 - Load tables (including the loads for Train Services and all relevant requirements and information in relation to the specification of those loads)

- Additional information applying to the requested Train Service which differs from other Train Services on the same Coal System

2 Interface Risk Management Plan

2.1 General

- (a) As a Railway Manager, Aurizon Network is responsible for ensuring that the Interface Risks associated with the operation of Train Services on the Rail Infrastructure are managed appropriately.
- (b) For the purpose of identifying the Interface Risks posed by the operation of a particular Train Service on the Rail Infrastructure, and agreeing an IRMP for managing those Interface Risks, Aurizon Network, the Access Holder and the Train Operator must participate in a process that commences with an Interface Risk Assessment and culminates in an IRMP (**Interface Risk Management Process**).
- (c) In progressing the Interface Risk Management Process, Aurizon Network, the Access Holder and the Train Operator must:
 - (i) ensure that their representatives involved in the process have the appropriate competence to conduct the process in a diligent manner;
 - (ii) ensure that all relevant information, that is reasonably available, is provided to the other party on a timely basis to facilitate the process; and
 - (iii) ensure that all information provided is accurate.
- (d) The Interface Risk Management Process must be conducted for all new Train Services and for any variation to Train Services (including changes in the Operating Plan or Rollingstock specification). For the avoidance of doubt, a variation to an existing Train Services will not require a new IRMP and varying the existing IRMP for those Train Services will satisfy the Interface Risk Management Process.
- (e) The IRMP must reflect the outcome of the Interface Risk Assessment. In particular, the IRMP will detail the controls agreed between Aurizon Network, the Access Holder and the Train Operator for the Interface Risks identified and assessed during the Interface Risk Assessment.
- (f) The IRMP must incorporate the audit, inspection and review regime under **clause 4** and must specify:
 - (i) the Safeworking Procedures and Safety Standards are applicable to the proposed operation;
 - (ii) the additional controls, including Rollingstock Interface Standards, agreed between the parties for the proposed operation; and

- (iii) the particular party responsible for ensuring that the various elements of the IRMP are implemented and that the IRMP remains effective in addressing the Interface Risks it was developed to address.
- (g) The IRMP must be a schedule to the Train Operator's Train Operations Deed. If a Train Operations Deed has been negotiated before the finalisation of the IRMP, the implementation of the IRMP may require changes to the terms and conditions of the Train Operations Deed, and the parties must agree those changes.
- (h) If Aurizon Network and an Access Holder or a Train Operator agree that training of the Access Holder's or Train Operator's personnel (as applicable) is required as a control, or part of a control, for a particular Interface Risk identified in the Interface Risk Assessment, and the Access Holder or Train Operator (as applicable) can only obtain that training from Aurizon Network, Aurizon Network must provide the Access Holder or Train Operator (as applicable) with that training (and Aurizon Network may recover its reasonable costs for providing such training).

2.2 Environmental matters

- (a) General
 - (i) The matters identified in this **clause 2.2** are the minimum environmental matters that must be addressed by the parties in an Interface Risk Assessment. The parties' assessment of Environmental Risks in an Interface Risk Assessment should not be restricted to an assessment of the matters referred to in this **clause 2.2**.
- (b) Water quality management
 - (i) The Train Operator must comply with all relevant water quality standards when carrying out activities under or in connection with the Train Operations Deed.
 - (ii) The Interface Risk Assessment must include an assessment of the impact of the Train Operator's proposed activities under or in connection with the Train Operations Deed on stormwater systems and natural waterways.
- (c) Air pollution management
 - (i) The Train Operator must consider the impact of its operations on air quality. In doing so, all relevant air quality standards and regulations should be met.
 - (ii) The Train Operator must undertake an Interface Risk Assessment which must consider the impact of the proposed operations on air quality. In doing so, all relevant air quality standards and regulations (including all requirements for

coal train operators in Aurizon Network's 'Coal Dust Management Plan' (as published on the Website from time to time) must be met.

- (iii) The Interface Risk Assessment must assess the likelihood:
 - (A) for dust and/or exhaust emissions from the proposed operations (including by reference to the type and chemical composition of the commodity being transported); and
 - (B) of those dust and/or exhaust emissions causing nuisance at any dwelling or home, library, childcare centre, kindergarten, school, college, university or other educational institution and hospital surgery or other medical institution.
- (d) Management of land contamination
 - (i) The Train Operator must comply with all relevant Laws, standards and guidelines in relation to land contamination when carrying out activities under or in connection with the Train Operations Deed.
 - (ii) The Interface Risk Assessment must include an assessment of the likelihood that the Train Operator's proposed activities under or in connection with the Train Operations Deed (including the Train Operator's activities during accidents, incidents and emergencies) will cause or contribute to land contamination.⁴
 - (iii) The Interface Risk Assessment must include all practicable control measures to prevent and manage land contamination.
- (e) Nature conservation
 - (i) The Interface Risk Assessment must include an assessment of:
 - (A) the impact of the Train Operator's proposed activities under or in connection with the Train Operations Deed on flora and fauna, including sensitive receptors in the vicinity of the Train Operator's proposed activities; and
 - (B) the risks and controls associated with wildfires being caused by exhaust or sparks from the Train Operator's Rollingstock.

⁴ Land contamination is a reference to the 'contamination' of land by a 'hazardous contaminant' as those terms are defined under the EP Act.

- (f) Management of dangerous goods
 - (i) The Train Operator must comply with Aurizon Network's requirements for the management of hazardous contaminants (as defined in the EP Act) and Dangerous Goods.
 - (ii) The Interface Risk Assessment must include an assessment of the risks associated with the management of "Dangerous Goods" (as defined in the Standard Train Operations Deed) by the Train Operator.
 - (iii) The Interface Risk Assessment must address any risks associated with the management of Dangerous Goods that are not specifically addressed by the requirements of **clause 22.7** of the Standard Train Operations Deed.
- (g) Waste management
 - (i) The Train Operator must comply with all relevant Laws and the requirements of any Authority in relation to the collection, removal, transport and disposal of any waste generated by the activities of the Train Operator under or in connection with the Train Operations Deed.
 - (ii) The Interface Risk Assessment must include an assessment of the impact of any waste produced by the Train Operator's proposed activities under or in connection with the Train Operations Deed.
- (h) Environmental noise management
 - (i) The Interface Risk Assessment must include an assessment of:
 - (A) The likely noise impacts attributable to the Train Operator's proposed activities under or in connection with the Train Operations Deed; and
 - (B) Whether the Train Operator's proposed activities under or in connection with the Train Operations Deed will comply with the "Noise Code" (as defined in the Train Operations Deed) or cause or contribute to any non-compliance with the Noise Code and detail all measures that will be taken to ensure that the Train Operator's proposed activities under or in connection with the Train Operations Deed do not cause or contribute to any non-compliance with the Noise Code.
- (i) Complaint management
 - (i) The Interface Risk Assessment must detail the Train Operator's procedure for handling complaints that are

received by the Train Operator as per the requirements of **clause 24.9** of the Standard Train Operations Deed.

- (j) Refuelling
 - (i) The Interface Risk Assessment must include an assessment of the impacts associated with refuelling activities (including mobile refuelling) undertaken in connection with the Train Operator's proposed activities under or in connection with the Train Operations Deed.

3 Environmental Management Plan

The Environmental Management Plan must specify (as a minimum):

- (a) the Environmental Risks identified in the IRMP from time to time and the measures in respect of those Environmental Risks specified in the IRMP from time to time of which the Train Operator is responsible for implementing, complying with, ensuring compliance with and/or ensuring the ongoing effectiveness;
- (b) processes for ensuring that the Train Operator at all times complies with all requirements imposed on it under Environmental Laws from time to time;
- (c) processes for ensuring that the Train Operator at all times complies with any requirements of the Environmental Authorities held by Aurizon Network from time to time that are notified by Aurizon Network to the Train Operator as relevant to the Train Operator's Train Services;
- (d) processes for ensuring that the Train Operator, its Rollingstock, Rollingstock Configurations and Train Services at all times comply with the requirements of this Agreement, including the IRMP and the Emergency Response Plan;
- (e) systems (including audit systems) and procedures to address and monitor all relevant Environmental Risks identified in the IRMP and to ensure compliance with all Environmental Laws;
- (f) the relevant roles, responsibilities and training of the Train Operator's staff involved in the implementation of the Environmental Management Plan; and
- (g) the following sections:

Introduction

- (i) Description of Operational Activities
- (ii) Purpose and Objectives of the Environmental Management Plan
- (iii) Description of Environmental Management Plan
- (iv) Operator's Environmental Policy

Environmental Management

- (v) Environmental Risks identified in the Interface Risk Assessment
- (vi) Legislation and Other Requirements
- (vii) Target/s

Implementation and Operation

- (viii) Responsibilities, Accountabilities & Authorities
- (ix) Competence, Training and Awareness
- (x) Internal and External Communication (including liaison with regulatory agencies)
- (xi) Document Control and Information / Record Management
- (xii) Emergency Preparedness and Management
- (xiii) Specific Procedures for identified environmental risks

Operational Activities Review Process

- (xiv) Monitoring and Measurement
- (xv) Evaluation of Compliance / Audit
- (xvi) Management Review

Environmental Complaints & Incidents

- (xvii) Managing Environmental Incidents
- (xviii) Notification of Environmental Incidents
- (xix) Managing Environmental Complaints

4 Inspection and Audit Provisions

4.1 Rights of inspection and audit

- (a) The IRMP must include a right for a party to conduct, or require the conduct of, an inspection or audit in accordance with this **clause 4** to assess the other party's compliance with the IRMP, the "Applicable Safeworking Procedures" and "Applicable Safety Standards" (each as defined by the Train Operations Deed) periodically as specified in the IRMP.
- (b) If a party reasonably believes that the other party has not complied, or is not complying, with any aspect of the IRMP, then that party may conduct, or require the conduct of, an inspection or audit in accordance with this **clause 4** and the process in the IRMP to assess the other party's compliance with the IRMP.
- (c) The party conducting, or requiring the conduct of, an inspection or audit (**Inspecting Party**) must give the other party at least five (5) Business Days prior notice of such inspection or audit (except that

such notice is not required in the case of emergencies) and that notice must include:

- (i) details of the inspection or audit to be carried out;
- (ii) the name of the person conducting the inspection or audit;
- (iii) the timing and expected duration of the inspection or audit;
- (iv) the location of the inspection or audit;
- (v) the grounds upon which the party requires the inspection or audit; and
- (vi) the party's requirements of the other party in relation to the inspection or audit.

4.2 Conduct of inspection or audit

- (a) Any inspection or audit may be conducted by the Inspecting Party, its appointed representative or by a suitably qualified person reasonably acceptable to both parties, but if the inspection or audit requires access to commercially sensitive information, then:
 - (i) person conducting the inspecting or audit must be independent of both parties; and
 - (ii) that person must, prior to being given access to the commercially sensitive information by the party the subject of the inspection or audit, execute a confidentiality deed on terms similar to the document in **Schedule I** in favour of the party the subject of the inspection or audit.
- (b) Aurizon Network, the Access Holder and/or the Train Operator (as applicable) must use reasonable endeavours to ensure that the Inspecting Party, its appointed representative or the person appointed to conduct an inspection or audit are entitled to enter and be upon its land and premises (whether or not owned or leased) for the purposes of carrying out any inspection or audit.
- (c) In exercising any inspection or audit, the Inspecting Party:
 - (i) must not interfere unreasonably with the Rail Infrastructure and the other party's Trains and Rollingstock or Train Movements on the Nominated Network; and
 - (ii) must use its reasonable endeavours to avoid damage or injury and to minimise any disruption to the other party's business activities.
- (d) The Inspecting Party is not liable for any delays or cancellation of Train Services or Claims suffered or incurred by or made or brought by or against the other party as a result of conducting the inspection or audit provided the Inspecting Party complies with this **clause 4.2**.
- (e) Aurizon Network, the Access Holder and/or the Train Operator (as applicable) must provide all reasonable assistance to the Inspecting

Party in conducting any inspection or audit including allowing the Inspecting Party, its appointed representative or person appointed to conduct an inspection or audit to discuss any relevant matter with its staff. A member of the "Staff" (as defined in the Train Operations Deed) of the party the subject of the inspection or audit may be present at the inspection or audit.

- (f) The parties must provide each other with a copy of any report of any inspection or audit in respect of its compliance with the IRMP.

4.3 Costs of inspection or audit

- (a) The Inspecting Party bears the reasonable costs of conducting the inspection or audit unless the inspection or audit confirms the stated grounds for the conduct of an inspection or audit of a party's operations have been demonstrated to exist, in which case the party whose operations are inspected or audited (**Audited Party**) must:
 - (i) bear the reasonable costs of conducting such inspection or audit; and
 - (ii) to the extent that the Inspecting Party has paid any costs of conducting such inspection or audit, reimburse the Inspecting Party such reasonable amounts paid by the Inspecting Party in conducting the inspection or audit.
- (b) Unless otherwise agreed, where the Inspecting Party requires the conduct of an inspection or an audit, the Inspecting Party is liable to the other party in respect of any reasonable loss or damage suffered or incurred by the audited party arising from the conduct of the inspection or audit if, and only if, no reasonable person in the position of the Inspecting Party could have formed the view that the stated grounds for such inspection or audit existed.
- (c) The Inspecting Party bears the burden of establishing that a reasonable person in its position could have formed that view.
- (d) Notwithstanding **clauses 4.3(b)** and **4.3(c)** Aurizon Network will not be liable to a Train Operator for any third party claims (including a claim for Consequential Loss) made against the Train Operator in relation to an inspection or audit where the third party is the Access Holder and the Access Holder has a direct contractual relationship with Aurizon Network in respect to the Access Rights to which the inspection or audit relates.

Schedule D

Ultimate Holding Company Deed

Aurizon Holdings Limited

Ultimate Holding Company Support Deed

Date:

2019

Party

Aurizon Holdings Limited ACN 146 335 622 of Level 15, 175 Eagle Street, Brisbane in the State of Queensland (**Aurizon Holdings**)

Background

- A Aurizon Network is the railway manager of certain rail transport infrastructure, access to which is provided in accordance with the Undertaking.
- B In order to comply with certain obligations imposed on Aurizon Network in accordance with the Access Undertaking, Aurizon Network seeks the cooperation of members of the Aurizon Corporate Group.
- C As required by **clause 2.5** of the Undertaking and the QCA's decision to approve the Undertaking, Aurizon Network has requested that Aurizon Holdings, as Aurizon Network's ultimate holding company, enter into this Deed in favour of the QCA. Aurizon Holdings has agreed to do so.
-

Agreed terms

1 Definitions

In this Deed the following terms will have the meanings set out below. All other terms have the meaning ascribed to them in the Access Undertaking.

Access Undertaking	The current access undertaking submitted by Aurizon Network to the Queensland Competition Authority and approved by the Queensland Competition Authority under the <i>Queensland Competition Authority Act 1997</i> (Qld) as at the date of this Deed and as amended or replaced from time to time.
Aurizon Corporate Group	Aurizon Holdings and each of its related bodies corporate (as that term is defined in the <i>Corporations Act 2001</i> (Cth)).
Aurizon Network	Aurizon Network Pty Ltd (ACN 132 181 116).
QCA	Queensland Competition Authority.

2 Term

Aurizon Holdings' obligations under this Deed will terminate upon the earlier of:

- (a) any new ultimate holding company of Aurizon Network providing a deed poll in substantially similar form to this Deed; or

- (b) expiry of the Access Undertaking.

3 Procuring Compliance by Aurizon Corporate Group

3.1 Procuring compliance with Access Undertaking

- (a) Aurizon Holdings must, and must use reasonable endeavours to procure that each other member of the Aurizon Corporate Group:
 - (i) take such reasonable steps as required to enable Aurizon Network to comply with the arrangements prescribed in **Part 3** of the Undertaking;
 - (ii) not direct or request Aurizon Network to act in contravention of **Part 3** of the Undertaking;
 - (iii) does not otherwise engage in any conduct which may prevent or hinder Aurizon Network from complying with **Part 3** of the Undertaking;
 - (iv) in relation to Confidential Information, not disclose Confidential Information received from Aurizon Network to any Third Party other than as permitted by the Undertaking or with the consent of the Access Seeker or Access Holder to which the Confidential Information belongs or relates;
 - (v) has the authority to provide or authorise access to land that an Access Seeker or Access Holder requires access to in accordance with the provision of Access under the Undertaking, where that land is owned by a member of the Aurizon Corporate Group, or where a member of the Aurizon Corporate Group has a lease, licence or other arrangement with the owners of the land or in accordance with the TIA (except that if a member of the Aurizon Corporate Group has entered into a lease, licence or other arrangement that does not permit Aurizon Network or Access Seekers onto the land, and access is otherwise required to provide the service taken to be declared under section 250(1)(a) of the Act, that member of the Aurizon Corporate Group may provide the QCA with details of the specific provisions and seek a waiver of this requirement);
 - (vi) takes steps required to allow Aurizon Network to sell or supply electric energy; and
 - (vii) enable or assist Aurizon Network to comply with its obligations in respect of the Undertaking.
- (b) No Aurizon Corporate Group member, including Aurizon Holdings, will take any action that would cause Aurizon Network to be in breach of its obligations in the Undertaking.

3.2 Benefit of Deed

This Deed is provided in favour of the QCA.

3.3 Non-compliance

The consequences of non-compliance with the obligations in **clause 3.1** of this Deed will be limited to those described in **clause 2.5(b)** of the Access Undertaking.

4 New Ultimate Holding Company

To the extent that Aurizon Holdings ceases to be the ultimate holding company of Aurizon Network, Aurizon Holdings will use its best endeavours to procure that the new ultimate holding company of Aurizon Network enters a deed poll in substantially similar form to this Deed as soon as reasonably practicable.

Execution

Executed as a deed.

**Executed by Aurizon Holdings
Limited**

.....
Director Signature

.....
Company Secretary Signature

.....
Name of Director (print)

.....
Name of Company Secretary (print)

Schedule E

Regulatory Asset Base

1 Maintenance of Regulatory Asset Base

1.1 Roll-forward principles

On an annual basis, Aurizon Network will roll forward the asset values in its Regulatory Asset Base applying the following principles:

- (a) the opening asset value, being for:
 - (i) the first Year of the Term, the value in the Regulatory Asset Base at the expiry of the 2016 Undertaking; and
 - (ii) each other Year in the Term, the value in the Regulatory Asset Base at the end of the immediately prior Year,
will be indexed for the Year using the change in the CPI between the June Quarter of the previous Year and the June Quarter for that Year;
- (b) depreciation of the assets will be calculated for the Year using asset lives and a depreciation profile as endorsed by the QCA;
- (c) if an asset is disposed of during the Year, the value of that asset recorded in the Regulatory Asset Base will be removed from the Regulatory Asset Base unless:
 - (i) the disposal necessarily results from an Expansion of, or Maintenance Work on, the Rail Infrastructure, in which case the Regulatory Asset Base will be reduced only by the net proceeds, if any, of the sale (on an arm's length basis) by Aurizon Network of the disposed asset; or
 - (ii) if **clause 1.1(c)(i)** does not apply, Aurizon Network can demonstrate to the QCA's satisfaction that less than that amount should be removed from the Regulatory Asset Base (in which case the amount approved by the QCA will be removed from the Regulatory Asset Base);
- (d) prudent and efficient capital expenditure for an asset will be added to the Regulatory Asset Base, where that expenditure has been approved by the QCA for inclusion into the Regulatory Asset Base in accordance with **clause 2**; and
- (e) the value of the assets in the Regulatory Asset Base will be adjusted in accordance with **clauses 1.2** and **1.4**, but only where that adjustment is approved by the QCA in accordance with those clauses.

1.2 Adjusting the value of assets in the Regulatory Asset Base

- (a) Subject to Aurizon Network obtaining the QCA's approval, the value of assets contained in the Regulatory Asset Base may be increased by including:
- (i) all or part (as appropriate) of the value of assets previously removed from the Regulatory Asset Base as a result of the operation of **clause 1.2(b)(ii)** if Aurizon Network can show to the QCA's satisfaction that demand for the declared service utilising those assets has increased sufficiently, or the factors giving rise to the removal have been sufficiently reduced or modified by new circumstances to justify including the value of the assets in the Regulatory Asset Base;
 - (ii) all or part (as appropriate) of the value of assets previously removed from the Regulatory Asset Base as a result of the operation of **clause 1.2(b)(iii)** where the deterioration of the Rail Infrastructure has been successfully addressed by Aurizon Network to the satisfaction of the QCA,

In making its determination, the QCA may:

- (iii) consult with, or seek submissions from, persons in relation to any consideration by the QCA of increasing the value of assets contained in the Regulatory Asset Base;
 - (iv) consider any relevant submissions made to the QCA; and
 - (v) request additional information from Aurizon Network that is reasonably required to make its determination in accordance with **clause 2.3(b)**
- (b) The QCA may require the value of assets contained in the Regulatory Asset Base to be reduced if:
- (i) the QCA made its decision to approve the relevant capital expenditure into the Regulatory Asset Base on the basis of information provided by Aurizon Network that was inaccurate or misleading, but only to the extent that were the information not inaccurate or misleading, the QCA's decision would have been different;
 - (ii) where the QCA determines that:
 - (A) actual demand for the declared service utilising an asset has deteriorated and that deterioration will be long term and sustained; and
 - (B) applying existing regulated pricing to those reduced volumes utilising that asset will result in a further material deterioration in demand for the declared service utilising that asset (including, without

limitation, by reason of mine closures, curtailing of mine production, or long term suspension of mine operations); but

- (C) the reduction in the Regulatory Asset Base may be made only to the extent necessary to address the circumstances set out in **clause 1.2(b)(ii)(A) and (B)**; and

(iii) where:

- (A) a Condition Based Assessment demonstrates that:

- (1) the Rail Infrastructure has deteriorated as a result of Aurizon Network's failure to implement good operating practice and pursue prudent and effective maintenance and asset replacement policies and practices; and
- (2) the deterioration of the Rail Infrastructure will be long term and sustained; and

- (B) Aurizon Network has no plan to remedy that deterioration; but

- (C) The reduction in the Regulatory Asset Base may be made only to the extent of the deterioration of the Rail Infrastructure described in **clause 1.2(b)(iii)(A)**.

(c) Where the QCA requires the value of the assets in the Regulatory Asset Base to be reduced:

(i) it must have regard to section 138(2) of the Act in:

- (A) considering any proposal that may be provided by Aurizon Network (including a draft amending access undertaking) to address a deterioration in demand; and
- (B) acting reasonably, determining whether the proposal will be effective to avoid a reduction in the Regulatory Asset Base;

(ii) it must identify those specific assets including the class and location of those assets;

(iii) in reaching its decision it:

- (A) must consult with, or seek submissions from, persons affected or likely to be affected by the decision;

- (B) may disclose any relevant information in respect of the specific assets to persons while seeking submissions;
 - (C) must consider all submissions made to it in relation to a reduction of the Regulatory Asset Base including any alternative proposal submitted by Aurizon Network that would avoid a Regulatory Asset Base reduction;
 - (D) may request any additional information from Aurizon Network that is reasonably required to make its determination; and
 - (E) may consider asset removal only if it determines, acting reasonably, that no other alternative mechanism which is appropriate having regard to the factors in s138(2) of the Act will be effective in addressing the circumstances set out in **clause 1.2(b)(ii)**.
- (iv) it must publish its draft decision and consult with, or seek submissions from persons in relation to its draft decision and consider all submissions made to it;
 - (v) it must have regard to section 138(2) of the Act in making its decision; and
 - (vi) it must publish its decision.

1.3 Reports on capital expenditure and Regulatory Asset Base roll-forward

- (a) Unless otherwise agreed between Aurizon Network and the QCA, Aurizon Network will, as soon as reasonably practicable and no later than four Months after the end of each Year in the Term, provide to the QCA the details for capital expenditure that Aurizon Network considers should be included in the Regulatory Asset Base with sufficient supporting evidence that the QCA may require to determine the prudence and efficiency of the capital expenditure under **clause 2**, including, as applicable:
 - (i) any relevant business case or Feasibility Study;
 - (ii) evidence of actual expenditure of the capital expenditure and commissioning of the associated asset; and
 - (iii) capacity modelling, if any, undertaken as part of the business case or Feasibility Study and on commissioning of the asset.
- (b) Unless otherwise agreed between Aurizon Network and the QCA, to the extent that the QCA, under **clause 2.2**, has accepted the capital expenditure in the report under **clause 1.3(a)** into the Regulatory

Asset Base, Aurizon Network (as soon as reasonably practicable and no later than one Month after the QCA's acceptance of the capital expenditure report under **clause 1.3(a)**) will provide to the QCA for approval Aurizon Network's roll-forward of the Regulatory Asset Base under **clause 1.1**, subject to **clause 1.2**, including details of:

- (i) the opening value of the Regulatory Asset Base for the relevant Year;
- (ii) indexation of the Regulatory Asset Base;
- (iii) depreciation of the Regulatory Asset Base;
- (iv) capital expenditure that is included in the Regulatory Asset Base;
- (v) disposals and transfers from the Regulatory Asset Base; and
- (vi) the closing value of the Regulatory Asset Base for the relevant Year (which will be the opening value of the Regulatory Asset Base for the following Year),

separately reported for each Coal System (including for each Reference Tariff and each User Funded Expansion).

- (c) If the information set out in a report provided to the QCA under this **clause 1.3** is insufficient, the QCA may request additional relevant information in accordance with **clause 2.3(b)**.
- (d) Information provided to the QCA under this **clause 1.3**:
 - (i) will be accompanied by a statement signed by Aurizon Network's Executive Officer confirming that, to the best of their knowledge, information is, in all material respects, correct; and
 - (ii) in respect of the report referred to in **clause 1.3(e)**, must be based on the roll forward principles in **clause 1.1**.
- (e) The QCA must approve the roll-forward of the Regulatory Asset Base submitted to it by Aurizon Network in accordance with **clause 1.3(b)**, if the QCA is satisfied that it has been conducted in accordance with the roll-forward principles in **clause 1.1**.

1.4 Equity raising costs

- (a) During or after the end of the Term, the value of assets contained in the Regulatory Asset Base may be increased by Aurizon Network by including an amount for any equity raising costs for the Approved Capital Expenditure over the Term which are reasonably required to maintain the benchmark capital structure of 55% debt and 45% equity (**Reasonable Equity Raising Costs**). Aurizon Network may increase the value of assets contained in the Regulatory Asset Base if the Reasonable Equity Raising Costs are calculated in accordance with this **clause 1.4** and approved by the QCA.

- (b) The amount approved by the QCA in **clause 1.4(a)** will be allocated amongst the Coal Systems (including allocations amongst Reference Tariffs), on a pro-rated basis by reference to Aurizon Network's Approved Capital Expenditure over the Term that will, subject to the QCA's approval, be applied in determining Reference Tariffs for the next regulatory period.
- (c) If the Expansion is a User Funded Expansion, references to Aurizon Network in this **clause 1.4** will be deemed to be references to Expansion Funders.

2 Approval of capital expenditure by the QCA

2.1 Overview

- (a) This **clause 2** refers to various determinations that the QCA may be requested to make for capital expenditure to be included in the Regulatory Asset Base.
- (b) These determinations may be made:
 - (i) in response to a report provided to it under **clause 1.3**; or
 - (ii) in advance of the capital expenditure being incurred.
- (c) Aurizon Network must obtain the QCA's approval under this **clause 2** of any capital expenditure prior to including that capital expenditure in the Regulatory Asset Base.
- (d) Failure by Aurizon Network to obtain the QCA's approval of any matters under this **clause 2** in relation to a capital expenditure project or part of the capital expenditure for a project, does not affect its right to seek approval under this **clause 2** at a later time in respect of part or all of that capital expenditure.
- (e) Subject to **clause 2.1(f)**, Aurizon Network must promptly seek approval of capital expenditure for a project under this **clause 2** following receipt of a request to do so by:
 - (i) an Access Seeker (or its Customer) requiring the capital expenditure project to be able to secure Access Rights;
 - (ii) an Expansion Funder for the Expansion; or
 - (iii) an Interested Participant,
 who requires Aurizon Network to obtain the QCA's approval of capital expenditure for a project or part of the capital expenditure for a project prior to incurring expenditure on the construction of that project.
- (f) Aurizon Network must promptly seek approval of capital expenditure for a project under this **clause 2** following acceptance of a Voting Proposal in respect of that capital expenditure project under **clause 4**. For clarity, Aurizon Network must also seek QCA pre-approval under this **clause 2** in respect of a Significant Electric Investment project.

- (g) If the capital expenditure for an Expansion is pre-approved for inclusion into the Regulatory Asset Base by the QCA:
 - (i) the actual expenditure of the Expansion up to the total of the pre-approved proposed expenditure under this **Schedule E** will be included into the Regulatory Asset Base if the process in **clause 2.2(e)** is complied with; and
 - (ii) the amount of any actual expenditure above the pre-approved proposed expenditure must be approved by the QCA prior to it being included into the Regulatory Asset Base.
- (h) For the purpose of **clause 2.2(a)** and related provisions in this **Schedule E**, a reference to capital expenditure includes expenditure for a Concept Study, Pre-feasibility Study, Feasibility Study or other study in connection with a capital expenditure project.

2.2 Prudency and efficiency

- (a) The QCA must approve including capital expenditure into the Regulatory Asset Base if that capital expenditure is for the prudent and efficient value of the assets that are used or intended to be used by Aurizon Network to provide the service taken to be declared under section 250(1)(a) of the Act.
- (b) In determining the prudency and efficiency of capital expenditure, the QCA must have regard to the following:
 - (i) the scope of works for the project (including whether the requirement for the works is prudent and efficient) which must include having regard, where relevant, to:
 - (A) any relevant Network Development Plan;
 - (B) the need to accommodate what is reasonably required to comply with Access Agreements and Train Operations Deeds;
 - (C) the need for new capital expenditure projects to accommodate the current contracted demand and potential future demand that Aurizon Network, acting reasonably, considers is required within a reasonable timeframe;
 - (D) the age and condition of existing assets, the need for asset replacement capital expenditure projects and the extent of consistency with the Asset Management Plan;
 - (E) the extent to which the capital expenditure project promotes the economically efficient operation of, use of or investment in the Rail Infrastructure, whether present or future (for example, in relation

- to extending the life of assets whose economic and/or functional life would otherwise have expired, reducing future operating and maintenance costs or improving the capability or capacity of existing assets, systems and processes);
- (F) Aurizon Network's legislative and tenure requirements, including relating to rail safety, workplace health, safety and environmental requirements;
 - (G) the outcomes of consultation (if any) about the capital expenditure project, with Access Seekers and Access Holders whose Access Charges (or likely Access Charges) would be affected by including the amount of capital expenditure for the capital expenditure project into the Regulatory Asset Base;
 - (H) the Renewals Strategy and Budget; and
 - (I) any other matters in submissions to the QCA by Aurizon Network or Expansion Funders;
- (ii) the standard of works for the project (including whether the standard could be expected to deliver the requirements for that project without it being overdesigned or likely to deliver a capital works project which is beyond the requirements of its scope) which must include having regard, where relevant, to:
- (A) the requirements of Railway Operators and what is reasonably required to comply with Access Agreements and Train Operations Deeds;
 - (B) current and likely future usage levels;
 - (C) the requirements of relevant Australian design and construction standards;
 - (D) if applicable, the extent of consistency with the Asset Management Plan;
 - (E) Aurizon Network's design standards contained within the Safety Management System;
 - (F) all relevant Laws and the requirements of any Authority (including the Safety Regulator);
 - (G) the Renewals Strategy and Budget; and
 - (H) any other matters in submissions to the QCA by Aurizon Network or Expansion Funders; and
- (iii) whether the costs of that project are prudent and efficient, having regard to the scope and standard of work undertaken

or to be undertaken for the project which must include having regard, where relevant, to:

- (A) any relevant Network Development Plan;
 - (B) the level of such costs relative to the scale, nature, cost and complexity of the project;
 - (C) the circumstances prevailing in the markets for:
 - (1) engineering, equipment supply and construction;
 - (2) labour; and
 - (3) materials;
 - (D) the Asset Management Plan;
 - (E) Aurizon Network's actions, or proposed actions, in relation to:
 - (1) safety during construction and operation;
 - (2) compliance with environmental requirements during construction and operation;
 - (3) compliance with Laws and the requirements of Authorities;
 - (4) minimising disruption to the operation of Train Services during construction;
 - (5) accommodating reasonable requests of Access Holders and End Users to amend the scope and sequence of works undertaken to suit their needs;
 - (6) minimising total project cost which may at times not be consistent with minimisation of individual contract costs;
 - (7) aligning other elements in the Supply Chain; and
 - (8) meeting contractual timeframes and dealing with external factors;
 - (F) the Renewals Strategy and Budget; and
 - (G) any other matters in submissions to the QCA by Aurizon Network or Expansion Funders.
- (c) When Aurizon Network submits information to the QCA for the QCA's assessment of whether capital expenditure is prudent and efficient, nothing in **clause 2** obliges Aurizon Network to submit such information to address all of the requirements of scope of work,

standard of work and costs set out at **clauses 2.2(b)(i) to (iii)**, but where one of those requirements is addressed by Aurizon Network, it must submit all of the information set out in **clauses 2.2(b)(i) to (iii)**, as applicable, as is reasonably relevant to the submission.

- (d) The QCA's acceptance of the prudence and efficiency of any of the scope of works, standard of works or costs of the capital expenditure project does not imply that it accepts other aspects of that project or approves of the inclusion of the capital expenditure in the Regulatory Asset Base.
- (e) If the QCA is requested to determine the prudence and efficiency of capital expenditure before the capital expenditure is incurred, the QCA may include as conditions of its approval for any capital expenditure for a project:
 - (i) the assumptions relevant to its approval including:
 - (A) cost to construct;
 - (B) time for completion of, and
 - (C) estimated capacity to be delivered by, the project;
 - (ii) other matters considered by the QCA to be material to its approval; and
 - (iii) the period of time in which the approval has effect (and if the project is not completed within the nominated time, the QCA may decide the approval ceases to have effect).
- (f) Despite **clause 2.3(d)**:
 - (i) if the QCA approves capital expenditure under this **clause 2** prior to that capital expenditure is incurred (**pre-approval capital expenditure**), that capital expenditure must not be included in the Regulatory Asset Base until it is incurred; and
 - (ii) once pre-approval capital expenditure is incurred, then Aurizon Network must obtain the QCA's approval under this **clause 2** prior to including the capital expenditure in the Regulatory Asset Base, and the QCA must approve the capital expenditure if the QCA confirms the capital expenditure has been incurred and Aurizon Network has satisfied the conditions required by the QCA as part of its pre-approval under **clause 2.2(e)**.
- (g) The QCA must, in assessing under **clause 2.2(b)** whether capital expenditure is prudent and efficient, consider only the circumstances relevant at the time of making the decision to incur the capital expenditure (or in relation to assessing prudence of costs, at the time when the costs were incurred or the capital expenditure project was undertaken, as applicable).

- (h) In assessing the prudence of capital expenditure on the basis of those circumstances, the QCA may take advice as it considers necessary from independent advisors using appropriate benchmarks and experience, and consult as it considers necessary with relevant stakeholders.
- (i) If Interested Participants vote in respect of whether to accept capital expenditure under **clause 4**:
 - (i) Aurizon Network must provide the QCA with the outcome of that vote promptly after the completion of the vote;
 - (ii) the QCA must take that vote into account when approving whether the capital expenditure is prudent and efficient; and
 - (iii) the vote by the Interested Participants under **clause 4** does not limit the QCA's review of the prudence and efficiency of the capital expenditure.
- (j) If Interested Participants accept a Voting Proposal under **clause 4** in respect of capital expenditure:
 - (i) the QCA may audit Aurizon Network's compliance with **clause 4** in accordance with **clause 10.6.3** of the Undertaking;
 - (ii) if that audit identifies any non-compliance with **clause 4** then:
 - (A) the QCA may require Aurizon Network to remedy the non-compliance; or
 - (B) if the non-compliance cannot be remedied, the QCA must deem the Interested Participants' vote to be invalid;
 - (iii) the QCA must take that vote into account when approving whether the capital expenditure is prudent and efficient; and
 - (iv) if the Interested Participant's vote is found or deemed to be invalid, Aurizon Network may elect to:
 - (A) withdraw its request to the QCA to approve the capital expenditure project under this **clause 2** and commence a new Voting Proposal in respect of that capital expenditure project under **clause 4**; or
 - (B) not commence a new Voting Proposal but to seek the approval of the QCA under this **clause 2** in respect of the capital expenditure project.
- (k) References to "Voting Proposal" in **clause 2.2** are to that term as defined in **clause 4**.

2.3 Approval by the QCA

- (a) To make its determination under **clause 2.2**, the QCA:

- (i) must consult with, or seek submissions from, persons in relation to any consideration by the QCA of the prudence and efficiency of capital expenditure;
 - (ii) may disclose any Feasibility Study in respect of a capital expenditure project or the Asset Management Plan provided to it under **clause 3** to persons while seeking submissions; or
 - (iii) must consider any relevant submissions made to the QCA, provided that without limiting the principles in **clause 11.2** of this Undertaking, the QCA must provide Aurizon Network with a reasonable opportunity to respond to any such submissions.
- (b) The QCA may request additional information from Aurizon Network that is reasonably required to make any determination under this **clause 2**.
- (c) The QCA must notify Aurizon Network if it approves capital expenditure for inclusion into the Regulatory Asset Base.
- (d) If the QCA is considering refusing to approve all or part of any capital expenditure into the Regulatory Asset Base:
- (i) the QCA must give Aurizon Network (and the User Funding Trustee and User Funders, if the capital expenditure is a User Funded Expansion) a draft of the QCA's decision (including a statement of reasons for reaching its decision);
 - (ii) Aurizon Network may, within twenty (20) Business Days after being given that draft decision (or such longer period as agreed by the QCA), revise the capital expenditure and/or provide additional information supporting its view that the capital expenditure or the revised amount should be included in the Regulatory Asset Base; and
 - (iii) the QCA must consider that revision and/or additional information when deciding whether to approve or refuse to approve the inclusion of the capital expenditure into the Regulatory Asset Base.
- (e) If the QCA refuses to approve all or part of any capital expenditure for inclusion in the Regulatory Asset Base, the QCA must give Aurizon Network (and the User Funding Trustee and User Funders, if the capital expenditure is a User Funded Expansion) a notice of the QCA's decision (including a statement of reasons and the clear identification of the capital expenditure project and the capital expenditure to which its decision relates).
- (f) Subject to **clause 2.1(g)** and **clause 2.1(h)**, Aurizon Network must promptly seek capital expenditure approval from the QCA prior to incurring capital expenditure on an Expansion which is reasonably likely to involve an amount of more than:

- (i) \$10 million in respect of a single Expansion project; or
 - (ii) where, with the proposed Expansion project, there will be more than one Expansion project within the same Coal System within a Year, a cumulative total of \$20 million.
- (g) Aurizon Network must:
- (i) by written notice at least 20 Business Days prior to seeking the QCA's approval under **clause 2.3(f)**, notify all:
 - (A) Access Seekers requiring the proposed Expansion project to be able to secure Access Rights;
 - (B) Customers in the relevant Coal System;
 - (C) Access Holders in the relevant Coal System; and
 - (D) Expansion Funders for the Expansion,
 of Aurizon Network's intention to seek QCA approval under **clause 2.3(f)**;
 - (ii) at least 20 Business Days prior to seeking the QCA's approval under **clause 2.3(f)**, give the parties referred to in **clause 2.3(g)(i)** a copy of the Independent Expert report referred to in **clause 2.3(h)**; and
 - (iii) promptly give such other information as the parties referred to in **clause 2.3(g)(i)** may, acting reasonably, require so as to enable those parties to make submissions to the QCA in relation to Aurizon Network's application for approval of capital expenditure on the Expansion.
- (h) Prior to making an application to the QCA for pre-approval of a capital expenditure project in accordance with **clause 2.3(f)** or proceeding with a Voting Proposal under **clause 4** in relation to such a project, Aurizon Network must obtain and provide to:
- (i) the QCA as part of the application for pre-approval; and
 - (ii) the parties referred to in **clause 2.3(g)(i)** prior to a vote under **clause 4**,
 - (iii) the Independent Expert report confirming:
 - (A) that an Expansion is required to provide Access Rights to which the proposed Expansion relates;
 - (B) that there will be sufficient Available Capacity in that Coal System following the Expansion to grant the Access Rights the subject of the relevant Access Application; and
 - (C) whether the Expansion proposed by Aurizon Network will deliver the Capacity required to meet

the Access Rights to which the proposed Expansion relates.

- (i) For the avoidance of doubt, the Capital Indicator does not imply any acceptance by the QCA of that level of capital expenditure into the Regulatory Asset Base.
- (j) Unless Aurizon Network otherwise elects to do so under **Part 8** of this Undertaking, Aurizon Network does not have an obligation to construct or fund a capital expenditure project as a result of seeking or obtaining any approval of the scope, standard or cost of a capital expenditure project under this **Schedule E**.
- (k) For clarity, this **clause 2.3** does not apply where:
 - (i) The QCA has already accepted the scope of the capital expenditure project as prudent;
 - (ii) The QCA accepts the scope of the capital expenditure project as prudent in accordance with **clause 2.2**; or
 - (iii) The scope of the capital expenditure project has been accepted as prudent by Interested Participants by a vote in accordance with **clause 4** of this **Schedule E**.

3 Asset Management Plan

- (a) Aurizon Network may prepare a proposed Asset Management Plan describing the standards that Aurizon Network will apply in determining whether to incur capital expenditure by replacing assets within the Regulatory Asset Base rather than maintaining those assets and submit that proposed Asset Management Plan to the QCA for approval.
- (b) To the extent that a capital expenditure project includes Asset Replacement and Renewal Expenditure and there is an Asset Management Plan, Aurizon Network may request the QCA's acceptance of the capital expenditure for that Asset Replacement and Renewal Expenditure as prudent and efficient.
- (c) If a request is made under **clause 3(b)**, the QCA may take into account whether the Asset Replacement and Renewal Expenditure is consistent with the Asset Management Plan.
- (d) **Clause 2** applies to any decision by the QCA in respect of the Asset Management Plan which, for clarity, includes refusing to approve the Asset Management Plan if it does not adequately assess the prudence and efficiency of the scope and standard of any Asset Replacement or Renewal Expenditure.

4 Acceptance of capital expenditure projects by Interested Participants

4.1 Application and purpose

(a) This **clause 4** is for the purpose of informing Aurizon Network and the QCA of the views of a broad range of Interested Participants in relation to capital expenditure projects, but (other than as described in **clause 2.1(f)** of this **Schedule E**) it does not bind either Aurizon Network or the QCA to accept those views. It therefore sets out a voting process for Access Holders, Customers and Access Seekers to provide their views on:

- (i) the prudence and efficiency of the scope of a capital expenditure project of any kind;
- (ii) the prudence and efficiency of the standard of works of a capital expenditure project of any kind;
- (iii) the prudence and efficiency of the costs of a capital expenditure project of any kind; or
- (iv) a material change to the scope, standard of works or costs of a capital expenditure project previously accepted by Interested Participants.

For clarity, Aurizon Network:

- (v) can seek a vote on any one or more of the matters listed in this clause; and
 - (vi) must, subject to **clause 4.1(b)**, seek a vote on all Significant Electric Investment projects.
- (b) Aurizon Network is not obliged to seek a vote of Interested Participants in relation to a Significant Electric Investment that involves funding from a third party and Aurizon Network is prevented by the confidentiality obligations owed to that third party from disclosing financial or other information necessary for an appropriately informed vote by Interested Participants. In those circumstances, Aurizon Network must still seek pre-approval by the QCA for the Significant Electric Investment as required by **clause 2.1(f)** of this **Schedule E**.
- (c) Aurizon Network may not seek a vote under this **clause 4** in relation to the matters set out in **clause 4.1(a)** unless:
- (i) it has completed the Feasibility Study for that project and provides the results of the Feasibility Study to the QCA and the Interested Participants (unless the Interested Participants agree that a Pre-feasibility Study is sufficient, in which case, it provides the results of the Pre-feasibility Study to the QCA and Interested Participants); and

- (ii) the Voting Proposal includes (either by reference to the results of the Feasibility Study or Pre-feasibility Study, if agreed by the Interested Participants, or as part of the proposal):
 - (A) the timeframe (including milestones (if any) and anticipated completion date) for constructing the capital expenditure project; and
 - (B) the cost tolerance for the capital expenditure project that is to be accepted as part of the Voting Proposal.
- (d) An unsuccessful vote does not prevent Aurizon Network from seeking the QCA's acceptance on the same matter or a future vote.
- (e) Aurizon Network must promptly notify the QCA:
 - (i) that it is seeking a vote; and
 - (ii) of the outcome of a vote,under this **clause 4**.
- (f) Aurizon Network is not obliged to seek acceptance of the matters set out in **clause 4.1(a)**, unless:
 - (i) an Access Seeker (or its Customer) requiring the capital expenditure project to be able to secure Access Rights;
 - (ii) an Expansion Funder for the Expansion; or
 - (iii) an Interested Participant,requires Aurizon Network to obtain a vote from Interested Participants, in which case Aurizon Network must promptly (and in any event within 20 Business Days of completion of the Feasibility Study for the relevant project) seek acceptance under this **clause 4**.
- (g) Promptly (and in any event within twenty (20) Business Days) after Interested Participants accept a Voting Proposal in respect of the matters set out in **clause 4.1(a)**, Aurizon Network must, unless otherwise agreed with the QCA, seek the approval of the QCA to include that capital expenditure into the Regulatory Asset Base.
- (h) In this **clause 4**:
 - (i) **Affected Train Path** means a Train Path:
 - (A) where the applicable Reference Tariff for a Train Service using that Train Path would be affected by including the amount of capital expenditure for the relevant capital expenditure project into the Regulatory Asset Base; or

- (B) that will be impacted by the proposed capital expenditure project after construction of the proposed Expansion is completed;
- (ii) **Interested Participants** means persons who satisfy the criteria set out in **clause 4.2(a)**;
- (iii) **Voting Period** means:
 - (A) the period specified in the notice under **clause 4.4(a)(i)**, being at least six weeks after the notice is given; or
 - (B) where the Interested Participants for at least 60% of the aggregated Affected Train Paths for all Interested Participants notify Aurizon Network request a specified extension to the period specified in the notice under **clause 4.4(a)(i)**, that extended period; and
- (iv) **Voting Proposal** means a proposal by Aurizon Network that Interested Participants accept by a vote relating to:
 - (A) any one or more of the following:
 - (1) the prudence and efficiency of scope of a capital expenditure project of any kind;
 - (2) the prudence and efficiency of standard of works of a capital expenditure project of any kind; and
 - (3) the prudence and efficiency of costs of a capital expenditure project of any kind;
 - (B) a material change to:
 - (1) the scope, standard or works or costs of; or
 - (2) the timeframe or cost tolerances for, a capital expenditure project previously accepted by Interested Participants; or
 - (C) a capital expenditure project commencing greater than two (2) years after the date that capital expenditure project was previously accepted by the Interested Participants.

4.2 Identification of Interested Participants

- (a) The Interested Participants for a Voting Proposal are Customers, and Access Holders and Access Seekers without Customers, where:
 - (i) the Access Charges (or likely Access Charges) relevant to the person:

- (A) are (or will be) determined by reference to a Reference Tariff; and
 - (B) would be affected by including the amount of capital expenditure for a capital expenditure project into the Regulatory Asset Base; or
 - (ii) the proposed capital expenditure project will impact on the person's contracted Capacity or Train Paths after construction of the proposed Expansion is completed.
- (b) A Customer who is an Interested Participant may (by notice to Aurizon Network) nominate its Access Seeker or Access Holder, as applicable, (**Nominee**) to vote on its behalf in which case:
- (i) the Nominee is taken to be the Customer's agent for the purposes of the vote; and
 - (ii) if requested by the Customer, Aurizon Network must provide the Customer with a copy of notices given to the Nominee under this **clause 4** contemporaneously with the giving of that notice to the Nominee.
- (c) Despite **clause 4.2(a)**:
- (i) Aurizon Network may not include a person as an Interested Participant if that would result in any 'double counting' of votes (for example, if two Access Seekers are competing to provide rail haulage services to a prospective Customer that Customer will not be treated as a Customer for each Access Seeker which would double its Affected Train Paths and consequential voting power); and
 - (ii) if a person has not been invited to participate as an Interested Participant but that person believes that it is entitled to participate, then that person:
 - (A) may notify Aurizon Network and the QCA together with its reasons for believing it is entitled to participate; and
 - (B) is an Interested Participant if the person satisfies the criteria set out in **clause 4.2(a)**,

and Aurizon Network must promptly notify the person and the QCA of its determination as to whether the person is an Interested Participant.

4.3 Voting rights

- (a) Each Interested Participant's vote will be that Interested Participant's Affected Train Paths determined by Aurizon Network (acting reasonably) as the Interested Participant's Access Rights (whether under an Access Agreement or the subject of an Access Application) as follows:

- (i) where the Access Agreement:
 - (A) will be in force five years after the first day of the Voting Period; or
 - (B) is subject to a legally binding commitment (even if conditional on the completion of an Expansion or Customer Specific Branch Line or other conditions which are Aurizon Network's responsibility to satisfy or can be waived by Aurizon Network),

the Affected Train Paths must be determined based on the Access Rights specified in that Access Agreement for a 12 Month period starting five years after the first day of the Voting Period;

- (ii) where:
 - (A) the Access Agreement is due to expire within five years after the first day of the Voting Period; and
 - (B) Aurizon Network reasonably expects that a Renewal will occur in relation to the relevant Access Rights under that Access Agreement,

the Affected Train Paths must be determined based on the Access Rights specified in that Access Agreement for the last period of twelve (12) Months of that Access Agreement;

- (iii) to the extent that the Interested Participant is (or is also) an Access Seeker or an Access Seeker's Customer:
 - (A) where the Available Capacity, plus the Capacity expected to be created by the capital expenditure project, that may potentially be used for Affected Train Paths (**Total Available Capacity**) is less than that needed by Aurizon Network to provide all of the Access Rights sought by Access Seekers (who, or whose Customers, are Interested Participants) for Affected Train Paths (**Requested Capacity**), the Affected Train Paths must be calculated as the Access Seeker's proportion of the Total Available Capacity calculated on a pro-rated basis by reference the Access Seeker's proportion of the Requested Capacity; or
 - (B) where the Total Available Capacity is greater than the Requested Capacity, the Affected Train Paths sought by the Access Seeker,

in either case, for a 12 Month period starting five years after the first day of the Voting Period; and

- (iv) if more than one of **clauses 4.3(a)(i) to (iii)** apply in respect of an Interested Participant, then the Affected Train Paths

calculated under those clauses will be aggregated for that Interested Participant except that an Affected Train Path may not be counted more than once.

4.4 Acceptance process

- (a) If Aurizon Network intends to put forward a Voting Proposal, then Aurizon Network must:
 - (i) identify the Interested Participants and notify each identified Interested Participant of the Voting Proposal; and
 - (ii) make available information the information set out in this **clause 4.4** to those Interested Participants.
- (b) During the Voting Period:
 - (i) Aurizon Network must use reasonable endeavours to provide information, forums and engage in discussions with Interested Participants in relation to the relevant Voting Proposal if requested by any Interested Participants; and
 - (ii) Interested Participants are to notify Aurizon Network of whether they accept or do not accept the Voting Proposal by voting 'yes' or 'no'.
- (c) If an Interested Participant votes:
 - (i) "no", the Interested Participant must provide its reasons for that vote so that the QCA may understand the Interested Participant's reasons; and
 - (ii) "yes", the Interested Participant may but is not required to provide any reasons for its decision.
- (d) If an Interested Participant does not respond within the Voting Period or does not respond in a way that is a clear 'yes' or 'no' vote, then the Interested Participant is deemed to have accepted the relevant Voting Proposal – that is, voted 'yes'.
- (e) The Interested Participants are deemed to have accepted the relevant Voting Proposal if Interested Participants for at least 60% of the aggregated Affected Train Paths for all Interested Participants have voted 'yes'.
- (f) Aurizon Network must notify each of those Interested Participants of the results of the vote within five (5) Business Days after Aurizon Network has determined those results.

4.5 Information and materials relating to acceptance votes

- (a) Aurizon Network must make available information, when it considers it relevant or necessary to do so, to Interested Participants relating to proposed capital expenditure projects relevant to Coal Systems.
- (b) Aurizon Network must make available to Interested Participants and the QCA information on the relevant capital expenditure project,

including the report prepared as a result of the Pre-feasibility Study (if agreed by Interested Participants) and the Feasibility Study (unless the Interested Participants agree to access the Pre-feasibility Study) for the relevant capital expenditure project.

- (c) Aurizon Network may require an Interested Participant to sign a confidentiality agreement substantially in the form set out in **Schedule I** prior to providing it information under this **clause 4.5**.

4.6 Compliance

- (a) Any person who is an Interested Participant in respect of a Voting Proposal who has any concerns about Aurizon Network's compliance with this **clause 4** in respect of the proposed vote may notify Aurizon Network and the QCA of those concerns in writing including providing reasons or other information in support of those concerns prior to the end of the Voting Period.
- (b) Aurizon Network must take whatever action is reasonably required to address any concerns notified to it under **clause 4.6(a)** to achieve compliance with this **clause 4**.
- (c) An audit of Aurizon Network's compliance with this **clause 4** in relation to a vote must be procured by Aurizon Network:
 - (i) prior to Aurizon Network relying on that vote for the purposes of the QCA's acceptance of prudence and efficiency of a capital expenditure project; and
 - (ii) subject to **clauses 4.6(d)** to **4.6(f)**, in accordance with **clause 10.6.4** of the Undertaking.
- (d) Where an audit is commenced under **clause 4.6(c)**:
 - (i) Aurizon Network must provide to the auditor copies of all concerns notified to it under **clause 4.6(a)** in relation to the relevant vote for the purpose of the audit certificate's preparation; and
 - (ii) the auditor will compile an audit report identifying:
 - (A) whether Aurizon Network has complied in all material respects with this **clause 4** and, if not, details as to the relevant non-compliance; and
 - (B) the process adopted for the conduct of the audit.
- (e) If, in preparing an audit certificate, the auditor identifies flaws in the calculation of the Affected Train Paths, then:
 - (i) Aurizon Network must recalculate the Affected Train Paths and recount the votes in a manner consistent with the auditor's findings;
 - (ii) the auditor will take that recalculation and recount into account in preparing the audit certificate; and

- (iii) to the extent that the Aurizon Network has already notified Interested Participants of the outcome of the vote, Aurizon Network will notify the Interested Participants as soon as reasonably practicable of the recounted vote.
- (f) If in preparing an audit certificate, the auditor identifies a material discrepancy in a vote of Interested Participants under this **clause 4**, then Aurizon Network must redo the voting process.

5 Capital expenditure reconciliation

- (a) Aurizon Network will maintain a register in which it records, in respect of each Year, all Approved Capital Expenditure for the Year including identifying:
 - (i) the relevant capital expenditure:
 - (A) by project;
 - (B) by whether it relates to electrification assets;
 - (C) by Coal System; and
 - (ii) whether the capital expenditure has been funded under a User Funding Agreement or by Aurizon Network.
- (b) The Allowable Revenues for the Year after the Year in which the QCA approves capital expenditure under **clause 2.2** will be adjusted by an amount which includes:
 - (i) a return on capital component, calculated as the difference between the return on capital assumed for the Capital Indicator for the Year in which that relevant capital expenditure was incurred and the return on capital that should have applied for the Approved Capital Expenditure for that same Year;
 - (ii) a depreciation component, calculated as the difference between the depreciation assumed for the Capital Indicator for the Year in which that relevant capital expenditure was incurred and the depreciation that should have applied for the Approved Capital Expenditure for the same Year; and
 - (iii) a tax depreciation component, calculated as the difference between the tax depreciation assumed for the Capital Indicator for the Year in which that relevant capital expenditure was incurred and the tax depreciation that should have applied for the Approved Capital Expenditure for the same Year,

and will be calculated using the modelling parameters and assumptions used to determine the Reference Tariffs accrued at the Discount Rate (**Capital Expenditure Allowable Revenue Adjustment**).

Schedule F

Reference Tariff

1 General provisions

1.1 Purpose

This **Schedule F** will be used for the following purposes:

- (a) Aurizon Network's formulation of Access Charges for a Train Service to which a Reference Tariff applies; and
- (b) where Access Charges, and related provisions, in an Access Agreement that were originally determined based on this **Schedule F** or Schedule F of an Applicable Undertaking, to allow for the adjustment of those Access Charges, and related provisions, in accordance with that Access Agreement for consistency with this **Schedule F** (as amended or replaced from time to time).

1.2 Application of Reference Tariffs

The Reference Tariffs in this **Schedule F** (including as updated in respect of the Reset Period):

- (a) apply to coal carrying Train Services from the Commencing Date to the Terminating Date; and
- (b) are based on a Reference Train Service.

1.3 General characteristics of Reference Train Services

The Reference Train Service in respect of the Reference Tariffs:

- (a) **(Commodity)** carries only bulk coal;⁵
- (b) **(Operational characteristics)** meets the following criteria:
 - (i) the additional Reference Train Service criteria listed in relation to the applicable Reference Tariff (for example, in **clauses 7.1, 8.1, 9.1, 10.1, and 11.1**);
 - (ii) complies with the maximum speeds permitted on the Nominated Infrastructure as specified in the relevant Preliminary Information;
 - (iii) complies with Aurizon Network's Rollingstock Interface Standards applicable to the Nominated Infrastructure;
 - (iv) is otherwise compatible with the Nominated Infrastructure described in the relevant Preliminary Information and

⁵ In defining bulk coal, no differentiation is to be made between coal qualities or types, or between the end use markets of the coal.

- requires no additional expenditure by Aurizon Network to implement varied Below Rail controls identified in the IRMP;
- (v) operates in accordance with nominated sectional running times specified in the relevant Preliminary Information;
 - (vi) uses bottom dump wagons with the “KWIK DROP” door operating mechanism; and
 - (vii) uses measures to minimise coal spillage and leakage and coal dust emissions en route that are consistent with the Coal Loss Mitigation Provisions in **Schedule J**;
- (c) **(Below Rail Services)** only requires services from Aurizon Network that are Below Rail Services and that Below Rail Services comprised in Access are provided in accordance with this Undertaking;
 - (d) **(Conditions of Access)** operates in accordance with an Access Agreement on substantially the same terms as a Standard Access Agreement applicable to coal carrying Train Services, where the differences from the Standard Access Agreement do not give rise to a material increase in cost or risk; and
 - (e) **(Train Service Entitlement)** has a Train Service Entitlement:
 - (i) based on Trains being available for operation 24 hours per day and 360 days per year; and
 - (ii) specified in terms of Cyclic Traffic which will:
 - (A) operate in accordance with the distribution set out in the MTP, Capability Train Plan or ITP (as applicable);
 - (B) have regard to Planned Possessions and any other matters agreed between Aurizon Network and other service providers in the relevant Supply Chain; and
 - (C) comply with the applicable scheduling procedures as set out in the Network Management Principles.

2 Reference Tariff

2.1 Composition of Reference Tariff

The Reference Tariff is a charge in relation to Train Services that have operated, calculated in accordance with **clause 2.2** and, if applicable, **clause 2.3** (including Adjustment Charges) with specified Reference Tariff inputs and, if applicable, any System Premiums or System Discounts.

2.2 Calculations for Reference Train Services

- (a) Subject to **clause 2.3**, a charge for Reference Train Services is calculated as:

$$\left(AT_1 \times \frac{gtk}{1000} \right) + (AT_2 \times rpt) + \left(AT_3 \times \frac{ntk}{1000} \right) + (AT_4 \times nt) + \left(AT_5 \times \frac{egtk}{1000} \right) + \left(EC \times \frac{egtk}{1000} \right) + (QCA Levy \times nt) + (IE Fee \times nt)$$

where:

AT₁ is the incremental maintenance tariff specified as the AT₁ input for the nominated Reference Train Service as specified for the relevant Reference Tariff (for example, as specified in **clauses 7.2, 8.2, 9.2, 10.2 and 11.2**, as applicable);

AT₂ is the incremental capacity tariff specified as the AT₂ input for the nominated Reference Train Service as specified for the relevant Reference Tariff (for example, as specified in **clauses 7.2, 8.2, 9.2, 10.2 and 11.2**, as applicable);

AT₃ is an allocative tariff specified as the AT₃ input for the nominated Reference Train Service as specified for the relevant Reference Tariff (for example, as specified in **clauses 7.2, 8.2, 9.2, 10.2 and 11.2**, as applicable);

AT₄ is an allocative tariff specified as the AT₄ input for the nominated Reference Train Service as specified for the relevant Reference Tariff (for example, as specified in **clauses 7.2, 8.2, 9.2, 10.2 and 11.2**, as applicable);

AT₅ is the electric access tariff specified as the AT₅ input for the nominated Reference Train Service as specified for the relevant Reference Tariff (for example, as specified in **clauses 7.2 and 8.2**, as applicable);

EC is the electric energy charge and includes the Variable Connection Charge which is initially (from the Commencing Date) as specified as the EC input for the nominated Reference Train Service as specified for the relevant Reference Tariff (for example, as specified in **clauses 7.2 and 8.2**, as applicable), and after the Approval Date as otherwise published by Aurizon Network on the Website on or about each 31 May during the Term after Aurizon Network seeks and obtains the QCA's approval for a new electric energy charge and Variable Connection Charge (taking into account any over or under recovery in the previous Year); and

IE Fee is the IE Fee for the following Year,

provided that the above calculation is subject to the addition of any applicable Adjustment Charge from time to time (including, if necessary, on a pro rata basis with other Train Services that have the same origin and destination and Access Holder and are run during same Billing Period, as the nominated Reference Train Service).

For clarity, the rtp for a Reference Train Service equals one.

- (b) The amounts of the AT₁, AT₂, AT₃, AT₄, AT₅, EC, IE Fee and the QCA Levy inputs (including the System Discounts and System Premiums, if

applicable) specified for the relevant Reference Tariff and any Adjustment Charge are GST exclusive.⁶

- (c) For the purposes of this **Schedule F**, a Train Service is a one way Train Service, that is, the journey from the Nominated Loading Facility to the Nominated Unloading Facility is one Train Service, and the return journey from the Nominated Unloading Facility to the Nominated Loading Facility is a second Train Service.
- (d) To the extent that the calculation of gtk and nt for a Train Service require a weight for the relevant Train or any Rollingstock comprised in that Train, weights may be nominal or actual weights, or a combination of nominal and actual weights provided that, unless otherwise agreed by Aurizon Network:
 - (i) any nominal weights will be as set out or calculated in the relevant Access Agreement or, otherwise, as agreed or approved by Aurizon Network, in relation to the calculation of gtk or nt, as applicable; and
 - (ii) actual weight will only be used where:
 - (A) the gross weight (in tonnes) of loaded or partly loaded wagons needs to be determined;
 - (B) there is a functioning weighbridge or weightometer (verified under the *National Measurement Act 1960* (Cth)) located en route between the origin and destination for the Train Service;
 - (C) Aurizon Network has agreed that the weighbridge or weightometer can be used to weigh wagons for the purpose of calculating Access Charges; and
 - (D) the relevant wagons can actually be weighed by that weighbridge or weightometer.
- (e) When Aurizon Network publishes the EC, it must separately identify the level of the Environment Compliance Charge and Variable Connection Charge within the EC.
- (f) In obtaining and seeking approval for the Variable Connection Charge discussed in **clause 2.2(e)** Aurizon Network shall provide to the QCA supporting invoices and calculation sheets clearly demonstrating the cost items and amounts that will be included in the Variable Connection Charge along with underlying assumptions used in identifying these cost components and how they are consistent with the definition of a Variable Connection Charge.

⁶ An amount for GST will be added to the total calculated Access Charge, in accordance with the provisions of the applicable Access Agreement, at invoicing.

2.3 Calculations for a Cross System Train Service

- (a) For a Cross System Train Service, the Reference Train Service description for each applicable Reference Tariff for each relevant Coal System will be applied to the extent that the Train Service is using that Coal System and the calculation under **clause 2.2** will be adjusted by applying the following:
- (i) AT_1 will be the AT_1 component of the Reference Tariff for:
 - (A) the Origin Tariff, for the gtk attributable to the Origin System; and
 - (B) the Destination Tariff, for the gtk attributable to the Destination System;
 - (ii) AT_2 will be determined as follows:
 - (A) the AT_2 component of the Reference Tariff in the Origin System will be applicable to the Train Paths used in the Origin System, but only if the Train Service operates on capacity constrained corridors of the Origin System as identified in **clause 2.3(b)**; and
 - (B) the AT_2 component of the Reference Tariff in the Destination System will be applicable in accordance with **clause 2.2**;
 - (iii) AT_3 will be the AT_3 input for the relevant Reference Tariffs for:
 - (A) the Origin Tariff, for the ntk attributable to the Origin System; and
 - (B) the Destination Tariff, for the ntk attributable to the Destination System; and
 - (iv) AT_4 will be the AT_4 input for the Origin Tariff;
 - (v) AT_5 and EC will be determined as the AT_5 and EC components of the Reference Tariff for:
 - (A) the Origin System, for the egtk attributable to the Origin System; and
 - (B) the Destination System, for the egtk attributable to the Destination System; and
 - (vi) the QCA Levy and IE Fee components of the Reference Tariff in the Destination System will be applicable in accordance with **clause 2.2**, applied to the nt for the Train Service.
- (b) For the purposes of **clause 2.3(a)(ii)**, unless otherwise approved by the QCA, the Rail Infrastructure comprising railways between:

- (i) Coppabella and the Hay Point Junction;
- (ii) Newlands and Abbot Point; and
- (iii) Burngrove and the port of Gladstone (including domestic coal terminals in the vicinity of Gladstone),

is regarded as capacity constrained Rail Infrastructure.

- (c) For the purpose of **clause 2.3(a)**, if a Cross System Train Service loads in the Blackwater System and unloads in the Newlands System, then the Goonyella to Abbot Point System is deemed to be the Destination System for that Cross System Train Service.

3 Calculations for Take or Pay

3.1 Overview

- (a) The Take or Pay payable to Aurizon Network will be calculated in a manner consistent with this **clause 3**.

3.2 Application of historical Take or Pay arrangements

- (a) A different manner of calculation may apply to a Take or Pay depending on the Applicable Undertaking in force at the time that the relevant Access Agreement was entered into.
- (b) This **clause 3.2** describes the application of the Take or Pay obligations contained in Access Agreements that were originally entered into in accordance with the 2001 Undertaking, 2005 Undertaking and/or 2008 Undertaking, given that the Take or Pay obligations reference the undertaking in force at the time of their application.
- (c) Where the Access Holder has a Take or Pay with Aurizon Network under an Access Agreement named in Column 1 (**2001/05/08 Access Agreement**), the Take or Pay will be calculated in accordance with Column 2, subject to the adjustments made in Column 3 of the corresponding row in the following table:

Column 1	Column 2	Column 3
<p>An Access Agreement that was executed or renewed on or after 20 December 2001 but prior to 30 June 2006.</p> <p>A New Access Agreement where the relevant Old Access Agreement was executed or renewed on or after 20</p>	<p>Clause 3.2, Part A, Schedule F of the 2001 Undertaking</p>	<p>Where the calculation refers to:</p> <ul style="list-style-type: none"> (a) the System Gtk; or (b) gtk in circumstances where that gtk relates to Train Services other than solely those under the relevant Access Agreement, <p>then exclude any gtk attributable to any Train Services where the Access Charges for those</p>

Column 1	Column 2	Column 3
December 2001 but prior to 30 June 2006.		<p>Train Services are set based on an Expansion Tariff.⁷</p> <p>The references to System GtK, System Forecast, and gtk in this row have the meanings given to those terms under the 2001 Undertaking.</p> <p>Where the calculation refers to the System Forecast, then that System Forecast is a reference to the Monthly System Forecast for the relevant Coal System set out in clause 12 of Schedule F.</p>
<p>An Access Agreement that was executed or renewed on or after 30 June 2006 but prior to 23 October 2008.</p> <p>A New Access Agreement where the relevant Old Access Agreement was executed on or after 30 June 2006 but prior to 23 October 2008.</p>	Clause 2.2, Part B, Schedule F of the 2005 Undertaking	<ol style="list-style-type: none"> 1. A reference in that calculation to the “System GtK”, or to gtk in circumstances where that gtk relates to Train Services other than solely those under the relevant Access Agreement, excludes any gtk attributable to any Train Services where the Access Charges for those Train Services are set based on an Expansion Tariff⁸. 2. A reference in that calculation to the “System Forecast” is a reference to the GtK Forecast for the relevant System Reference Tariff. 3. A reference to “Paragraph 7.4.4(f) of the Undertaking” is a reference to clause 12.4(f) of this Undertaking.
<p>An Access Agreement that was executed or renewed on or after 23 October 2008 but prior to 1 October 2010.</p> <p>A New Access Agreement where the relevant Old Access Agreement was executed on or 23 October 2008 but</p>	Clause 2.2, Part B, Schedule F of the 2008 Undertaking	<ol style="list-style-type: none"> 4. A reference to “Total Actual Revenue” is a reference to Total Actual Revenue as defined under this Undertaking. 5. A reference to “Individual Coal System Infrastructure” is a reference to the System Reference Tariff that is used to set the Access Charges for the relevant Train Services, subject to item 7 below. 6. A reference to “System Allowable Revenue” is a reference to Allowable Revenue as defined under this Undertaking.

⁷ Access Agreements for coal carrying Train Services executed or renewed on or after 20 December 2001 but prior to 30 June 2006 (**UT1 Access Agreements**) will have Access Charges for Train Services in a Coal System set based on the relevant System Reference Tariff for that Coal System. Train Services under a UT1 Access Agreements will not have Access Charges set based on any Expansion Tariff for that Coal System. The relevant System GtK or gtk should be limited to those Train Services whose Access Charges are set based on the same System Reference Tariff as the relevant Train Services for which a Take or Pay is being calculated. In the same way, the Monthly System Forecasts for each Coal System only relate to Train Services whose Access Charges are set by based on the relevant System Reference Tariff.

⁸ Access Agreements for coal carrying Train Services executed or renewed under the 2005 Undertaking or 2008 Undertaking (except for a Customer initiated transfers of UT1 Access Agreements) (**UT2 Access Agreements**) will have Access Charges for Train Services in a Coal System set based on the relevant System Reference Tariff for that Coal System. Train Services under UT2 Access Agreements will not have Access Charges set based on any Expansion Tariff for that Coal System. The relevant System GtK or gtk should be limited to those Train Services whose Access Charges are set based on the same System Reference Tariff as the relevant Train Services for which a Take or Pay is being calculated.

Column 1	Column 2	Column 3
prior to 1 October 2010.		<p>7. A reference to “Access Agreements in relation to that Individual Coal System Infrastructure” is a reference to Tariff Based Access Agreements in relation to the relevant System Reference Tariff.</p> <p>8. A reference to “the Total Revenue for that Individual Coal System Infrastructure” is a reference to “the Total Revenue” in relation to the relevant System Reference Tariff.</p>

3.3 Application of new Take or Pay arrangements

- (a) This **clause 3.3** describes the application of the Take or Pay obligations contained in Access Agreements that were originally entered into in accordance with the 2010 Undertaking, the 2016 Undertaking and this Undertaking. Nothing in this **clause 3.3** applies to a 2001/05/08 Access Agreement. (Note: Take or Pay in the context of new Expansions is addressed in **clause 3.3(n)** below.)
- (b) Subject to **clause 3.3(n)** which applies to Take or Pay in the context of Expansions, where the Access Holder has a Take or Pay with Aurizon Network under an Access Agreement that is not a 2001/05/08 Access Agreement, the Take or Pay will be calculated as follows:
- (i) first, the maximum potential Take or Pay will be calculated based on **clauses 3.3(d) to (f)**; and
 - (ii) second, **clause 3.3(h)** will be applied to determine whether any Take or Pay liability exists; and
 - (iii) third, if Take or Pay liability exists, for the purpose of calculating Tariff Take or Pay in relation to a System Reference Tariff and to that extent only, the maximum potential Take or Pay will be adjusted by applying each of:
 - (A) **clause 3.3(j) (Mine capping)**; and
 - (B) **clause 3.3(k) to (m) (Tariff capping)**,
as applicable and in that order to determine the actual Take or Pay payable to Aurizon Network.
- (c) In relation to Take or Pay charges in the context of a Pre-Approval Date Coal Access Agreement where the Access Holder is not a Train Operator, Take or Pay charges will be payable under that Access Agreement (including in relation to the non-operation of Train Services under any relevant train operations agreement). Take or Pay charges will not be payable to Aurizon Network by a Train Operator under a train operations agreement relevant to that Access Holder.
- (d) Subject to **clauses 3.3(h) to (m)**, Take or Pay charges applicable to an Access Holder will be:
- (i) determined for each Year;

- (ii) invoiced for each Year following completion of that Year; and
- (iii) calculated as the amount which is 100% of the amount calculated as:

$$\left(AT_2 \times rtp \times NTS \right) + \left(AT_3 \times \frac{ntk}{1000} \right) + \left(AT_4 \times nt \right)$$

where:

- (A) each of AT₂, AT₃ and AT₄ inputs for that Access Holder's Access Charges at the rate applicable in that Year;
- (B) the nt and ntk (as applicable) are calculated by:
- (1) the aggregate nt and ntk (as applicable) that would have been achieved for the relevant Year had the full contracted entitlement been railed for the relevant Train Services; less
 - (2) the aggregate nt and ntk (as applicable) not railed for the relevant Year due to the non-operation of Train Services for an Aurizon Network Cause; less
 - (3) the aggregate nt and ntk (as applicable) railed for the relevant Year; and
- (C) NTS is calculated as:
- (1) the number of Train Services that the Access Holder would have operated for the relevant Year had the full contracted entitlement been railed for the relevant Train Services; less
 - (2) the number of those Train Services that either:
 - were not able to be operated solely as a result of an Aurizon Network Cause; or
 - were operated (whether loaded or empty) during that Year,

provided always that the amount of Take or Pay for a relevant Year must not be less than zero.

- (e) To calculate nt and ntk for the purpose of **clause 3.3(d)(iii)(B) (1) and (2)**, Aurizon Network must:

- (i) identify from the Access Agreement the number of Train Services that would have operated had the full contracted entitlement been used; and
- (ii) determine the number of Train Services that did not operate under that contracted entitlement due to an Aurizon Network Cause, provided that if an Access Holder has more than one Access Agreement for the same origin to destination pair, Aurizon Network must allocate those Train Services as between the relevant Access Agreements in the order in which those Access Agreements were executed (unless the relevant Access Holder has nominated a different order, in which case that order must be applied),

and calculate the n_t and n_k by using a train payload as reasonably determined by Aurizon Network in respect of the relevant Reference Tariff.

- (f) For the purpose of calculating Take or Pay charges, the calculation will be based on the origin and destination specified in the relevant Train Service Entitlement .
- (g) For the purpose of calculating Take or Pay charges, an Access Holder's entitlement to operate Train Services is, without limitation, determined by reference to the Train Services that could have been operated in accordance with the Access Holder's Train Service Entitlement including even if:
 - (i) where the Access Holder is not a Train Operator:
 - (A) the Access Holder has not nominated a Train Operator to utilise Access Rights relevant to all or any of the Train Services;
 - (B) either:
 - (1) the Access Holder must ensure a Train Operator does not operate; or
 - (2) Aurizon Network suspends the right of the Access Holder to have a Train Operator operate,
 all or any of the Train Services; or
 - (C) under the relevant Train Operations Deed, either:
 - (1) the relevant Train Operator must not operate; or
 - (2) Aurizon Network suspends the right of the relevant Train Operator to operate,
 all or any of the Train Services; or

- (ii) where the Access Holder is a Train Operator, the Access Holder must not operate, or Aurizon Network suspends the right of the Access Holder to operate, all or any of the Train Services,

except to the extent of any express exceptions specified in the Access Holder's Access Agreement for the purpose of calculating Take or Pay charges where the Access Holder is taken to not have an entitlement to operate Train Services.

Take or Pay trigger

- (h) For the purpose of calculating Tariff Take or Pay in relation to a System Reference Tariff and to that extent only, the Tariff Take or Pay for a Year is not payable for that Year where the aggregate of the gtk for all coal carrying Train Services, to the extent that the Access Charges for those Train Services are set by reference to the relevant Reference Tariff, operated for that Year exceeds the amount calculated as:
 - (i) 100% of the Gtk Forecast identified for that Year for that Reference Tariff; less
 - (ii) the gtk not achieved due to the non-operation of Train Services for an Aurizon Network Cause.
- (i) Where Tariff Take or Pay for a System Reference Tariff is being determined, **clauses 3.3(j)** and **(m)** only apply where Tariff Take or Pay is payable after **clause 3.3(h)** has been applied.

Mine capping

- (j) If:
 - (i) Train Services operated in relation to an origin to destination in respect of a person (**End User**) who is either the Customer for those Train Services or the Access Holder for those Train Services (but who has no Customer) under an Access Agreement, exceed the Train Service Entitlement in that Access Agreement (**Exceeded Agreement**); and
 - (ii) there is another Access Agreement (excluding Access Agreements executed or renewed prior to 1 October 2010, and New Access Agreements where the relevant Old Access Agreement was executed or renewed within the same period) (**Other Agreement**) with Train Service Entitlements for that same origin to destination and that End User that have not been exceeded,

then the Take or Pay liability under the Other Agreement will be reduced by the amount of the additional revenue from Access Charges for AT₂₋₄ from those excess Train Services under the Exceeded Agreement but only to the extent that both that Take or Pay

liability and those Access Charges are set by reference to the same Reference Tariff. For clarity:

- (iii) where the additional revenue is greater than the Take or Pay liability under one or more Other Agreements, that additional revenue may be used to reduce the Take or Pay liability under those Other Agreements (where there is more than one Other Agreement, the reduction will be pro-rated, on the basis of the total revenue from AT₂₋₄ that Aurizon Network is entitled to earn over the relevant Year under each of those Other Agreements, assuming Train Services were operated with a Nominal Train Payload); and
- (iv) the additional revenue from an Exceeded Agreement can only be used for a reduction of Take or Pay liability under this **clause 3.3(j)** in respect of the Year in which that additional revenue arose and cannot be accrued, rolled over or otherwise used to reduce a Take or Pay liability for any other Year.

Tariff capping

- (k) **Clause 3.3(l)** must only be applied after **clause 3.3(j)** (if applicable) has been applied.
- (l) Subject to **clause 3.3(m)**, and to **clause 3.3(j)** (if applicable) having first been applied, where the Total Actual Revenue for AT₂₋₄ in relation to Access Charges set by reference to the relevant Reference Tariff less the aggregate amount of Tariff Take or Pay that Aurizon Network is entitled to earn from all Access Agreements executed or renewed on or after 30 June 2006 (other than any new or varied Access Agreement to the extent entered or varied as part of transferring Access Rights from existing Access Agreements in place on the day immediately prior to 30 June 2006 under a provision of the Access Agreement which permits the transfer of Access Rights) (Total Revenue) is:
 - (i) greater than or equal to the Allowable Revenue for AT₂₋₄ in relation to the relevant Reference Tariff, Tariff Take or Pay is not payable for that Year under those Access Agreements (**Full Take or Pay Agreements**); or
 - (ii) less than the Allowable Revenue for AT₂₋₄ in relation to that Reference Tariff:
 - (A) Aurizon Network must calculate the aggregate amount of Tariff Take or Pay that Aurizon Network is entitled to earn from all Full Take or Pay Agreements (**Total Actual Take or Pay**); and
 - (B) if the Total Actual Take or Pay exceeds the amount by which the Allowable Revenue for AT₂₋₄ in relation to the relevant Reference Tariff exceeds

the Total Revenue from Access Charges set by reference to the relevant Reference Tariff (**Maximum Take or Pay Amount**), then:

- (1) Aurizon Network must calculate for each relevant Access Holder, the proportion that the Access Holder's Tariff Take or Pay amount bears to the Total Actual Take or Pay (**Proportion**); and
 - (2) each relevant Access Holder's Tariff Take or Pay amount will be reduced to equal that Access Holder's Proportion of the Maximum Take or Pay Amount.
- (m) In determining what Aurizon Network would be entitled to earn for the purposes of **clause 3.3(l)**, Aurizon Network is deemed to have contracted on the terms of the relevant Standard Access Agreement (as defined under the Applicable Undertaking) that applied on the date of execution or renewal of an Access Agreement, except for:
- (i) those Access Agreements which have been altered by agreement from that form in a manner consistent with the terms of any Approved Undertaking or approval of the QCA, in which case Aurizon Network's entitlement will be calculated in accordance with the terms of such Access Agreements; and
 - (ii) a New Access Agreement to the extent entered into as part of transferring Access Rights from an Old Access Agreement executed under the 2001 Undertaking, under a provision of the Access Agreement which permits the transfer of Access Rights, in which case Aurizon Network's entitlement to Tariff Take or Pay amounts will be calculated on the basis that Aurizon Network has contracted on the terms of the relevant Standard Access Agreement (as defined under the 2001 Undertaking) that applied on the date of execution of that Old Access Agreement.

Take or Pay for Expansions

- (n) In relation to Take or Pay in the context of an Expansion Tariff:
- (i) The Take or Pay amount for an Access Holder that is required to pay an Expansion Tariff will be calculated in accordance with:
 - (A) the formulae in **clause 3.3(d)(iii)**; plus
 - (B) $AT5 \times egtk / 1000$;where the egtk is calculated by:
 - (C) the aggregate egtk that would have been achieved for the relevant Year had the full contracted

- entitlement been railed for the relevant Train Services; less
- (D) the aggregate egtk not railed for the relevant Year due to the non-operation of Train Services for an Aurizon Network Cause; less
- (E) the aggregate egtk railed for the relevant Year; provided always that the amount of Take or Pay for the Year must not be less than zero.
- (ii) In order to calculate egtk for the purposes of this clause, Aurizon Network will:
 - (A) identify from the Access Agreement the number of Train Services that would have operated had the full contracted entitlement been used;
 - (B) determine the number of Train Services that did not operate under that contracted entitlement due to an Aurizon Network Cause; and
 - (C) convert this to egtk by using the Nominal Train Payload for the relevant Reference Tariff as reasonably determined by Aurizon Network.
- (iii) For the avoidance of doubt:
 - (A) there is no Take or Pay trigger test – ie, **clause 3.3(h)** does not apply; and
 - (B) there are no capping mechanisms – ie, **clauses 3.3(j) to (m)** do not apply.

4 Annual review of Reference Tariffs

4.1 Requirement for annual review of Reference Tariffs

- (a) Prior to the beginning of each Year during the Term (except for the first Year) each Reference Tariff will be adjusted by Aurizon Network to reflect the variations to the applicable Allowable Revenue:
 - (i) for the relevant Year due to an adjustment to Second Year Allowable Revenue under **clause 4.4**;
 - (ii) for the relevant Year due to an adjustment for Capital Expenditure Allowable Revenue Adjustment under **clause 5(b) of Schedule E**; and
 - (iii) for the relevant Year and each subsequent Year during the Term in accordance with **clause 4.1(b)**.
- (b) Aurizon Network will submit to the QCA by 28 February of each Year during the Term:

- (i) a revised Gtk Forecast for each Reference Tariff for the next Year;
- (ii) details of the methodology, data and assumptions used to estimate the revised Gtk Forecast; and
- (iii) either:
 - (A) the Approved Maintenance Strategy and Budget for the next Year if by 28 February there is an Approved Maintenance Strategy and Budget for the next Year; or
 - (B) if by 28 February there is no Approved Maintenance Strategy and Budget for the next Year:
 - (1) the proposed final Maintenance Strategy and Budget referred to in **clause 7A.11.3(k)(iii)** of the Undertaking; and
 - (2) subject to confidentiality restrictions, all information provided to Aurizon Network by the Chair of the Rail Industry Group in relation to next Year's Maintenance Strategy and Budget,

for the Year commencing 1 July 2020 and each subsequent Year;
- (iv) either:
 - (A) the Approved Renewals Strategy and Budget for the next Year if by 28 February there is an Approved Renewals Strategy and Budget for the next Year; or
 - (B) if by 28 February there is no Approved Renewals Strategy and Budget for the next Year:
 - (1) the proposed final Renewals Strategy and Budget referred to in **clause 7A.11.3(m)(iii)** of the Undertaking; and
 - (2) subject to confidentiality restrictions, all information provided to Aurizon Network by the Chair of the Rail Industry Group in relation to next Year's Renewals Strategy and Budget,

for the Year commencing 1 July 2020 and each subsequent Year;
- (v) the value of the proposed Maintenance Indicator for the next Year as specified or determined under **clause 7A.11.4(a)**, **clause 7A.11.4(b)** or **clause 7A.11.4(e)** of the Undertaking

- (as applicable) for the Year commencing 1 July 2020 and each subsequent Year;
- (vi) the value of the proposed Capital Indicator for the next Year as specified or determined under **clause 7A.11.4(c)**, **clause 7A.11.4(d)** or **clause 7A.11.4(e)** of this Undertaking (as applicable) for the Year commencing 1 July 2020 and each subsequent Year;
 - (vii) the proposed adjustments, for each Reference Tariff, to:
 - (A) the Allowable Revenue for the Reference Tariff for each subsequent Year during the Term; and
 - (B) the Reference Tariff for the next Year,arising from any difference between:
 - (C) the relevant revised GtK Forecast and the GtK Forecast used for the purpose of determining the Allowable Revenue for that Reference Tariff;
 - (D) for the Year commencing 1 July 2020 and each subsequent Year, the proposed Maintenance Indicator for the next Year and the forecast maintenance costs used for the purpose of determining the Allowable Revenue for that Reference Tariff;
 - (E) for the Year commencing 1 July 2020 and each subsequent Year, the proposed Capital Indicator for the next Year and the forecast capital expenditure used for the purpose of determining the Allowable Revenue for that Reference Tariff; and
 - (F) for the Year commencing 1 July 2018 and each subsequent Year, the proposed Tax Allowance (applying Gamma) for the next Year and the forecast Tax Allowance used for the purpose of determining the Allowable Revenue for that Reference Tariff.
 - (viii) with effect from 28 February 2020, the value of the forecast IE Pass Through Cost for the next Year and the IE Fee for that Year.
- (c) For clarity, for the period from 1 July 2017 to 30 June 2023:
- (i) there will be no Reference Tariff adjustments pursuant to **clause 4.1(b)** in respect of:
 - (A) the Non-Electric Operating Expenditure Allowance;
 - (B) Indirect Maintenance Costs;

- (C) the return on capital as described in Section 5 of the QCA's 2018 Decision; and
 - (D) the return of capital as described in Section 3 of the QCA's 2018 Decision;
 - (E) the Capital Carryover; and
- (ii) any change in Electric Operating Expenditure Allowance will be treated as an Endorsed Variation Event.
- (d) If, after receiving a submission under **clause 4.1(b)** or **clause 4.1(h)**, the QCA considers that:
- (i) an error has been made in the proposed revised Gtk Forecast or the proposed revised Gtk Forecast is not reasonable;
 - (ii) the Maintenance Indicator is not consistent with the Maintenance Indicator approved by the QCA following submission of Maintenance Indicator by Aurizon Network under either **clause 7A.11.4(a)** or **clause 7A.11.4(b)** of the Undertaking (as applicable) ;
 - (iii) the Capital Indicator is not consistent with the Capital Indicator approved by the QCA following submission of Capital Indicator by Aurizon Network under either **clause 7A.11.4(c)** or **clause 7A.11.4(d)** of the Undertaking (as applicable);
 - (iv) an error has been made in the adjustments to Allowable Revenue for any Reference Tariffs;
 - (v) an error has been made in the adjustments to any Reference Tariff,
- then:
- (vi) the QCA will endeavour to notify Aurizon Network within forty (40) Business Days, providing details of the:
 - (A) error of the kind referred to in **clause 4.1(d)(i)**, **4.1(d)(iv)** or **4.1(d)(v)**;
 - (B) lack of reasonableness of the kind referred to in **clause 4.1(d)(i)**; or
 - (C) inconsistency of the kind referred to in **clause 4.1(d)(ii)** or **4.1(d)(iii)**,
 in order for the QCA to approve it; and
 - (vii) after receiving that notice, Aurizon Network must within ten (10) Business Days either:
 - (A) show why it does not consider the QCA's view with respect to the:

- (1) error of the kind referred to in clause **4.1(d)(i), 4.1(d)(iv) or 4.1(d)(v)**;
 - (2) lack of reasonableness of the kind referred to in **clause 4.1(d)(i)**; or
 - (3) inconsistency of the kind referred to in **clause 4.1(d)(ii) or 4.1(d)(iii)**,

is correct; or

 - (B) resubmit a corrected or amended (as applicable) version of the submission.
- (e) The QCA will, in respect of the matters submitted under **clause 4.1(b) or clause 4.1(h)**, approve:
 - (i) the revised Gtk Forecast, if it considers that the revised Gtk Forecast is reasonable;
 - (ii) subject to **clause 7A.11.4(a)(ii)** and **clause 7A.11.4(b)** of the Undertaking, the Maintenance Indicator;
 - (iii) subject to **clause 7A.11.4(c)(ii)** and **clause 7A.11.4(d)** of the Undertaking, the Capital Indicator;
 - (iv) the revised Tax Allowance if it has been calculated correctly; and
 - (v) the consequential adjustments to Allowable Revenues and Reference Tariffs if they are calculated properly.
- (f) To the extent that Aurizon Network does not make a submission under **clause 4.1(b)** in respect of the Gtk Forecast, Maintenance Indicator, Capital Indicator, Tax Allowance, Allowable Revenues or Reference Tariffs for a Year by 28 February, then no adjustments to the Gtk Forecast, Maintenance Indicator, Capital Indicator, Tax Allowance, Allowable Revenues or Reference Tariffs (as applicable) for that Year will be made under this **clause 4.1**.
- (g) **Schedule K** has been included for the purposes of transparency as to the forecast Maximum Allowable Revenue for the period from 1 July 2017 to 30 June 2023.
- (h) Within 30 days of the QCA approving the Reset Schedule F Preliminary Inputs, Aurizon Network will submit to the QCA an update of **Schedule K** to include forecast Maximum Allowable Revenue for the period of 1 July 2023 to 30 June 2027 by including the amounts set out in **Schedule K** for each of those Years applying the amounts approved by the QCA under **Part 6A** of this Undertaking and otherwise applying the following principles:
 - (i) Maintenance Indicator and the Capital Indicator will be for each of those Years that amount applicable in the Year commencing 1 July 2023 as determined under **clause 7A.11** of this Undertaking; and

- (ii) Non-Electric Operating Cost Allowance will be for each of those Years that amount applied for the Non-Electric Operating Cost Allowance in the calculation of the Reference Tariffs for the Year commencing 1 July 2023.

4.2 Allowable Revenue

- (a) Subject to **clause 4.2(b)**, the Allowable Revenue:
 - (i) for AT₂₋₄ in relation to a Reference Tariff for a Year, is the total revenue from AT₂₋₄ arising from all Tariff Based Access Agreements in relation to that Reference Tariff that Aurizon Network is entitled to earn over the relevant Year as specified in the Reference Tariff (for example, as specified in **clauses 7.3, 8.3, 9.3, 10.3 and 11.3 of Schedule F**, as applicable), as amended from time to time, and as adjusted or varied in accordance with this **Schedule F** (but, for clarity, excluding any Adjusted Allowable Revenue); and
 - (ii) for the AT₅ component of Access Charges in relation to a Reference Tariff for a Year, is the total revenue from the AT₅ component of Access Charges arising from all Tariff Based Access Agreements in relation to that Reference Tariff that Aurizon Network is entitled to earn over the relevant Year as specified in the Reference Tariff (for example, as specified in **clauses 7.3 and 8.3 of Schedule F**, as applicable) as amended from time to time, and as adjusted or varied in accordance with this **Schedule F**.
- (b) Unless otherwise agreed with the QCA, when calculating Allowable Revenue in relation to the Origin Tariff and the Destination Tariff for a Cross System Train Service, regardless of when the Cross System Train Service commenced:
 - (i) for the Allowable Revenue for AT₂₋₄:
 - (A) the sum of the following components of Access Charges that Aurizon Network would be expected to earn in respect of a forecast Cross System Train Service:
 - (1) the AT₂ components calculated based on the relevant Destination Tariff and on **clause 2.3(a)(ii) of Schedule F**; and
 - (2) 50% of the AT₃ components calculated based on the relevant Destination Tariff,will be allocated to Allowable Revenue for the Destination Tariff; and
 - (B) all other Access Charges attributable to AT₂₋₄ which Aurizon Network would be expected to earn in respect of a forecast Cross System Train Service

calculated based on the Origin Tariff applicable to that Cross System Train Service, will be allocated to the Allowable Revenue of the Origin Tariff; and

- (ii) for the Allowable Revenue for AT₅, the AT₅ component of Access Charges that Aurizon Network would be expected to earn in respect of a forecast Cross System Train Service, calculated based on:
 - (A) the Origin Tariff and the egtk in the Origin System, will be allocated to the Allowable Revenue for the Origin Tariff; and
 - (B) the Destination Tariff and the egtk in the Destination System, will be allocated to the Allowable Revenue for the Destination Tariff.

4.3 Calculation of Revenue Adjustment Amounts

Obligation to calculate Revenue Adjustment Amounts

After the end of each Year, Aurizon Network will calculate for that Year for each Reference Tariff:

- (a) an AT₂₋₄ Revenue Adjustment Amount for that Reference Tariff by subtracting:
 - (i) the Adjusted Allowable Revenue for AT₂₋₄ (calculated under **clause 4.3(c)**) for that Reference Tariff; from
 - (ii) the Total Actual Revenue for AT₂₋₄ (calculated under **clause 4.3(d)**) in relation to that Reference Tariff, for that Year less, where **clause 4.3(l)** applies, the Electric Revenue Adjustment; and
- (b) an AT₅ Revenue Adjustment Amount for that Reference Tariff by subtracting:
 - (i) the Adjusted Allowable Revenue for AT₅ (calculated under **clause 4.3(c)**) for that Reference Tariff; from
 - (ii) the Total Actual Revenue for AT₅ (calculated under **clause 4.3(j)**) in relation to that Reference Tariff, for that Year, except where **clause 4.3(l)** applies, the AT₅ Revenue Adjustment Amount must be adjusted by adding the Electric Revenue Adjustment.

Calculation of Adjusted Allowable Revenue

- (c) The Adjusted Allowable Revenue for AT₂₋₄ or the AT₅ component of Access Charges in relation to a Reference Tariff is the sum of the following components of the applicable Allowable Revenue (as relevant to the applicable Allowable Revenue):

- (i) the components relating to the Approved WACC that apply during the relevant Year, adjusted to reflect the difference between:
- (A) the actual Approved WACC; and
 - (B) the Approved WACC that was used for the purpose of determining the relevant Reference Tariff for the relevant Year;
- (ii) the component relating to the recovery of Aurizon Network's maintenance costs, adjusted to reflect:
- (A) for the Years commencing 1 July 2017, 1 July 2018 and 1 July 2019, where the actual maintenance costs are lower than the Maintenance Indicator for that Year, that difference; and
 - (B) for the Year commencing 1 July 2020 and each subsequent Year, the difference between:
 - (1) actual maintenance costs approved by the QCA under **clause 7A.11.5** of the Undertaking; and
 - (2) the sum of:
 - the Maintenance Indicator for the relevant Year; and
 - the variable maintenance cost adjustment calculated by multiplying the relevant AT1 Reference Tariff (actual gtk – Gtk Forecast);
- (iii) for the Year commencing 1 July 2021 and each subsequent Year, a component relating to the recovery of Aurizon Network's Non-Electric Operating Expenditure Allowance, excluding those costs referred to in **clause 4.3(c)(ii) (NOEA Component)** for the Year calculated in accordance with the following formula:

$$\text{NOEA Component} = \text{NOEA} + \text{NOEA Adjustment}$$

Where:

NOEA means the Non-Electric Operating Expenditure Allowance used for the purpose of determining the applicable Allowable Revenue for the Year; and

NOEA Adjustment means:

- (a) if the actual CPI value for the Year (**Actual CPI**) is equal to or less than 2.37%, zero; or
- (b) if the Actual CPI exceeds 2.37%, an amount calculated in accordance with the following formula:

(Actual CPI – 2.37%) x NOEA

- (iv) the components relating to the recovery of Aurizon Network's costs associated with the connection of Aurizon Network's electrical traction system to an electricity transmission or distribution network, adjusted to reflect the difference between:
 - (A) the actual costs for the relevant Year; and
 - (B) the forecast costs used for the purpose of determining the relevant Reference Tariff for the relevant Year which includes the allocated Variable Connection Costs;
- (v) the components relating to the recovery of Aurizon Network's costs for the cost of audits required under this Undertaking (whether at the request of the QCA or End Users) for the relevant Year, but only to the extent that the QCA has approved in writing the relevant audit costs as efficiently incurred and such costs are not already recoverable by Aurizon Network elsewhere in this Undertaking;
- (vi) the components relating to the recovery of Aurizon Network's costs for the cost of any Condition Based Assessment required under this Undertaking by the QCA for the relevant Year, but only to the extent that the QCA has approved in writing the relevant Condition Based Assessment costs as efficiently incurred and such costs are not already recoverable by Aurizon Network elsewhere in this Undertaking;
- (vii) the component relating to the recovery of Aurizon Network's costs for ground penetrating radar measurement, but only to the extent that these costs have been prudently and efficiently incurred and are not already recoverable by Aurizon Network elsewhere in this Undertaking;
- (viii) the components relating to the payment by Aurizon Network of rebates relating to the capital components of Access Charges attributable to the use of all or part of specified assets relating to the relevant Reference Tariff (other than under a User Funding Agreement), adjusted to reflect the difference between:
 - (A) the actual payment of rebates made under those agreements for the applicable assets; and
 - (B) the forecast payments of those rebates used for the purpose of determining the relevant Reference Tariff for the relevant Year;

- (ix) the components relating to the recovery of Aurizon Network's costs relating to, or arising out of compliance with this Undertaking that were not allowed for in the determination of the relevant Reference Tariff, but only to the extent that the QCA has approved in writing the relevant costs as efficiently incurred and such costs are not already recoverable by Aurizon Network elsewhere in this Undertaking; and
 - (x) all components excluding those costs referred to in any of **clauses 4.3(c)(i) to (ix)**.
- (ca) Adjusted Allowable Revenue for the Year commencing 1 July 2023 and any subsequent Year in which the Preliminary Limited Update Inputs applied will also take into account:
- (i) the extent to which the Limited Update Inputs are different to the corresponding Preliminary Limited Update Inputs for the period that the Preliminary Limited Update Inputs applied; and
 - (ii) the extent to which the Tax Allowance for that relevant Year would also have been different as a consequence of the difference referred to in **clause 4.3(ca)(i)**.

Calculation of Total Actual Revenue for AT₂₋₄

- (d) Subject to **clause 4.3(i)**, the Total Actual Revenue for AT₂₋₄ in relation to the relevant Reference Tariff is the sum of:
- (i) total revenue from AT₂₋₄, including all revenue from Overload Charges and any Ancillary Revenues relating to maintaining connections to Private Infrastructure (except to the extent that costs associated with maintaining connections to any Private Infrastructure are not specifically allowed for in the relevant Reference Tariff), for coal carrying Train Services, in relation to the relevant Reference Tariff that operated in the Year, that Aurizon Network would have earned (regardless of what it actually earned or collected), if that revenue were calculated consistent with the following:
 - (A) for a Train Service that is:
 - (1) consistent with the relevant Reference Train Service; and
 - (2) is not a Cross System Train Service, the AT₂, AT₃ and AT₄ components of the relevant Reference Tariff;
 - (B) for a Cross System Train Service that is consistent with the relevant Reference Train Service (to the extent that the relevant Reference Tariff applies), that part of the AT₂, AT₃ and AT₄ components of the relevant Reference Tariff allocated consistently

- with the method used in the calculation of the relevant Allowable Revenue under **clause 4.2(b)**;
- (C) for a Train Service that varies from the relevant Reference Train Service due to it not complying with:
- (1) **clause 1.3(b)(v)**, the AT₂ component of the Access Charge (where the Access Charge varies from the Reference Tariff under **clause 6.2.3(c)** of this Undertaking) and the AT₃ and AT₄ components of the relevant Reference Tariff; or
 - (2) any other part of **clause 1.3(b), (d) or (e)** (other than **clause 1.3(b)(v)** – with which it complies), the AT₂, AT₃ and AT₄ components of the relevant Reference Tariff; or
- (D) for a Train Service where the QCA has otherwise approved an Access Charge that differs from the relevant Reference Tariff, the amount of the AT₂, AT₃ and AT₄ components of the relevant Access Charge;
- (ii) the amount of all Take or Pay and, subject to **clause 4.3(f) and 4.3(h)**, Relinquishment Fees and Transfer Fees which Aurizon Network would be entitled to be paid in the relevant Year under Tariff Based Access Agreements, for coal carrying Train Services, in relation to the relevant Reference Tariff (or, for a Cross System Train Service, to the extent the relevant Reference Tariff applies to the setting of Access Charges for that Cross System Train Service) calculated on the basis that Aurizon Network is deemed to have contracted on the terms of the relevant Standard Access Agreement (as defined under the Applicable Undertaking) that applied on the date of execution or renewal of an Access Agreement, except for:
- (A) those Access Agreements which have been altered from the relevant Standard Access Agreement in accordance with any Approved Undertaking or as approved by the QCA, for which Aurizon Network's entitlement to Take or Pay amounts, Relinquishment Fees or Transfer Fees will be calculated in accordance with the terms of those Access Agreements; and
 - (B) a New Access Agreement to the extent entered into as part of transferring Access Rights from an Old Access Agreement executed under the 2001

Undertaking, under provisions of the Access Agreement which permits the transfer of Access Rights, which has not been renewed after 30 June 2006, for which Aurizon Network's entitlement to Take or Pay amounts, Relinquishment Fees and Transfer Fees will be calculated on the basis that Aurizon Network has contracted on the terms of the relevant Standard Access Agreement (as defined under the 2001 Undertaking) that applied on the date of execution of that Old Access Agreement; and

- (iii) subject to **clause 4.3(e)**, all revenue from AT₂₋₄ that Aurizon Network would have been entitled to earn under a Tariff Based Access Agreement in relation to the relevant Reference Tariff during the relevant Year but for

Aurizon Network's breach of that Access Agreement or negligence in the provision of Below Rail Services to the extent that such events of breach or negligence resulted in the non-provision of 5% or more of the total number of Train Services for any single origin-destination pair during the relevant Year (provided that, where Access Rights are held by a party that is not a Train Operator, the 5% threshold is measured across the number of Train Services for each single origin to destination pair under that Access Agreement, not any relevant Train Operations Deed), less any interest comprised in those amounts representing interest paid or payable to Aurizon Network in relation to Access Charges (including any Adjustment Charges).

- (e) Where, for an origin-destination pair, Aurizon Network can demonstrate that, for an origin-destination pair:
- (i) it has paid a Rebate under **clause 7A.6** of this Undertaking in respect of an event of breach or negligence which is also an event of breach or negligence that results in the non-provision of Train Services for the purposes of the calculation referred to in **clause 4.3(d)(iii)** for a Year (**Relevant Event**); and
- (ii) the Rebate paid for the Relevant Event related to the non-provision of more than 5% of the total number of Train Services for the origin-destination pair during the relevant Year (provided that, where Access Rights are held by a party that is not a Train Operator, the 5% threshold is measured across the number of Train Services for each single origin to destination pair under that Access Agreement, not any

relevant Train Operations Deed) (**Non-provision Percentage**),

the 5% threshold specified in **clause 4.3(d)(iii)** will, in respect to the origin-destination pair be taken to be increased to the Non-provision Percentage.

- (f) Subject to the QCA's approval, Aurizon Network may reduce the amount of any Relinquishment Fee or Transfer Fee used to calculate Total Actual Revenue for a Year if its inclusion will have a material effect on the AT₂₋₄ Revenue Adjustment Amount.
- (g) If Aurizon Network reduces the amount of any Relinquishment Fee or Transfer Fee under **clause 4.3(f)**, then the amount of the reduction must be carried forward to a following Year, including a return on capital amount, calculated by reference to the Discount Rate over the period starting on the first day of the Year in which the Relinquishment Fee or Transfer Fee is received and ending on the first day of the Year in which the Relinquishment Fee or Transfer Fee is included in the calculation of Total Actual Revenue.
- (h) Where an Access Holder is not required to pay a Relinquishment Fee under **clause 7A.5(a)(iii)** of the Undertaking, the Relinquishment Fee that would have otherwise been payable but for **clause 7A.5(a)(iii)** of the Undertaking, will not be included in the calculation under **clause 4.3(d)(ii)**.
- (i) If in a Coal System Aurizon Network delivers (and End Users utilise) more than the Committed Capacity (ignoring any relief which Aurizon Network may be entitled to (such as force majeure)), any payment of a Rebate under **clause 7A.6** of this Undertaking in respect of a Coal System will be deducted from the Total Actual Revenue (but only to the extent of the revenue that Aurizon Network earns as a result of Aurizon Network delivering more than the Committed Capacity for the Coal System). For clarification, any payment of a Rebate will not otherwise be deducted from Total Actual Revenue.

Calculation of Total Actual Revenue for the AT₅ component of Access Charges

- (j) Subject to **clause 4.3(i)**, the Total Actual Revenue for the AT₅ component of Access Charges in relation to the relevant Reference Tariff is the sum of:
 - (i) total revenue from the AT₅ component of Access Charges arising from all Tariff Based Access Agreements, for coal carrying Train Services, in relation to the relevant Reference Tariff that Aurizon Network has actually earned over the relevant Year (whether or not actually collected by Aurizon Network), calculated using:

- (A) for a Train Service for which **clause 6.9.1(b)** of this Undertaking applies, the amount of the AT₅ component of the relevant Access Charges; or
- (B) if **paragraph (A)** does not apply:
 - (1) for a Cross System Train Service that is consistent with the relevant Reference Train Service, the AT₅ component of the relevant Reference Tariff allocated consistently with the method used in the calculation of the relevant Allowable Revenue under **clause 4.2(b)**; or
 - (2) where **paragraph (1)** does not apply, the AT₅ component of the relevant Reference Tariff; and
- (ii) subject to **clause 4.3(k)**, all revenue from the AT₅ component of Access Charges that Aurizon Network would have been entitled to earn under a Tariff Based Access Agreement in relation to the relevant Reference Tariff during the relevant Year but for Aurizon Network's breach of that Access Agreement or negligence in the provision of Below Rail Services to the extent that such events of breach or negligence resulted in the non-provision of 5% or more of the total number of Train Services for any single origin-destination pair during the relevant Year (provided that, where Access Rights are held by a party that is not a Train Operator, the 5% threshold is measured across the number of Train Services for each single origin to destination pair under that Access Agreement, not any relevant Train Operations Deed),

less any interest comprised in those amounts representing interest paid or payable to Aurizon Network in relation to Access Charges (including any Adjustment Charges).

- (k) Where, for an origin-destination pair, Aurizon Network can demonstrate that, for an origin-destination pair:
 - (i) it has paid a Rebate under **clause 7A.6** of this Undertaking in respect of an event of breach or negligence which is also an event of breach or negligence that results in the non-provision of Train Services for the purposes of the calculation referred to in **clause 4.3(d)(iii)** for a Year (**Relevant Event**); and
 - (ii) the Rebate paid for the Relevant Event related to the non-provision of more than 5% of the total number of Train Services for the origin-destination pair during the relevant Year (provided that, where Access Rights are held by a party

that is not a Train Operator, the 5% threshold is measured across the number of Train Services for each single origin to destination pair under that Access Agreement, not any relevant Train Operations Deed) (**Non-provision Percentage**),

the 5% threshold specified in **clause 4.3(d)(iii)** will, in respect to the origin-destination pair be taken to be increased to the Non-provision Percentage.

Calculation of Electric Revenue Adjustment

- (l) Where:
- (i) the relevant Reference Tariff is a System Reference Tariff;
 - (ii) there is a Decline in Electric Utilisation for the relevant Year; and
 - (iii) there is an AT₅ Revenue Shortfall for the relevant Year,
- the Electric Revenue Adjustment is the lesser of:
- (A) the amount calculated by multiplying the following amounts together:
 - (1) the amount calculated by subtracting the Electric Utilisation Level from the Electric Utilisation Floor for the relevant Reference Tariff;
 - (2) the aggregate actual gtk for the relevant Coal System that was used to calculate the Electric Utilisation Level; and
 - (3) the relevant AT₅ Reference Tariff; and
 - (B) the AT₅ Revenue Shortfall Amount.

Approval of Revenue Adjustment Amounts

- (m) Aurizon Network will submit to the QCA by 31 October after the end of each Year of the Term details of the methodology, data and assumptions used to calculate the Revenue Adjustment Amounts for that Year under this **clause 4.3** and **clause 4.4** provided that if, in that October, Adjustment Charges have not yet been approved relating to the relevant Year, then Aurizon Network is only required to submit the relevant information within thirty (30) days after those Adjustment Charges have been approved.
- (n) The QCA may give Aurizon Network a notice requiring Aurizon Network to submit the Revenue Adjustment Amounts, if Aurizon Network fails to do so under **clause 4.3(m)**.
- (o) The QCA may grant Aurizon Network an extension of the time for submitting, or resubmitting, the Revenue Adjustment Amounts if:

- (i) Aurizon Network provides a written request to the QCA for an extension of time; and
- (ii) the extension of time is reasonable or necessary.

If an extension of time is granted, Aurizon Network will submit the Revenue Adjustment Amounts within the time specified by the QCA.

- (p) The QCA may calculate Revenue Adjustment Amounts that are consistent with the requirements specified in this **clause 4.3**:
 - (i) if Aurizon Network does not comply with a notice from the QCA under **clause 4.3(n)** or **4.3(s)(ii)**; or
 - (ii) if the QCA, under **clause 4.3(s)(ii)**, refuses to approve the Revenue Adjustment Amounts resubmitted by Aurizon Network.
- (q) Where Aurizon Network submits the Revenue Adjustment Amounts under **clause 4.3(m)**, the QCA may, to the extent it considers it appropriate to do so:
 - (i) publish details of the Revenue Adjustment Amounts; and
 - (ii) invite and consider comments from stakeholders regarding the Revenue Adjustment Amounts.

To the extent that such comments are provided, the QCA must give Aurizon Network a reasonable period to respond to those comments.
- (r) The QCA will approve any Revenue Adjustment Amounts if the QCA is reasonably satisfied that they have been calculated in accordance with this **clause 4.3**.
- (s) If the QCA:
 - (i) approves the Revenue Adjustment Amounts, the QCA will give Aurizon Network a notice stating the reasons for the QCA's decision; or
 - (ii) refuses to approve the Revenue Adjustment Amounts, the QCA will give Aurizon Network a notice:
 - (A) stating the reasons for its refusal and the way in which it considers that the Revenue Adjustment Amounts should be amended; and
 - (B) requiring Aurizon Network to amend the Revenue Adjustment Amounts in that way and to resubmit the Revenue Adjustment Amounts to the QCA within thirty (30) days after Aurizon Network receives that notice.
- (t) Aurizon Network must comply with a notice under **clause 4.3(s)(ii)**.

- (u) The QCA may approve Revenue Adjustment Amounts resubmitted by Aurizon Network or developed by the QCA under **clause 4.3(p)**, if it is satisfied that they:
 - (i) are consistent with the matters specified under **clause 4.3(q)**; and
 - (ii) if a notice has been issued under **clause 4.3(s)(ii)**, have been amended or developed in accordance with that notice.
- (v) Despite any other provision of this Undertaking, to the extent that:
 - (i) Adjustment Charges have been approved for a Year;
 - (ii) Aurizon Network is entitled or obliged to recover or reimburse those Adjustment Charges from or to Access Holders;
 - (iii) Aurizon Network is obliged under this Undertaking to calculate Revenue Adjustment Amounts in respect of that Year; and
 - (iv) in recovering or reimbursing the Adjustment Charges, the Adjustment Charges are included in an invoice relating to a Billing Period in the Year in which the relevant Revenue Adjustment Amounts are required to be calculated,

then, the Total Actual Revenue for AT₂₋₄ or AT₅ for each relevant Coal System for that Year and the Year in which the relevant Revenue Adjustment Amounts are required to be calculated must be adjusted to take account of the Adjustment Charges (but excluding the interest component of those Adjustment Charges).

4.4 Revenue adjustment

- (a) Where a Revenue Adjustment Amount has been approved by the QCA under **clause 4.3**:
 - (i) the equivalent Allowable Revenue to that used in the calculation of that Revenue Adjustment Amount for the relevant Reference Tariff for the Year after the Year in which that Revenue Adjustment Amount was calculated (that is, the **Second Year Allowable Revenue**) must be adjusted in accordance with this **clause 4.4**; and
 - (ii) the Allowable Revenue for all subsequent Years must also be adjusted to reflect the actual change in the , CPI as used in the calculation of the approved Revenue Adjustment Amount.
- (b) A Second Year Allowable Revenue will be adjusted as follows:
 - (i) for an AT₂₋₄ Revenue Adjustment Amount, by subtracting from the relevant Second Year Allowable Revenue:
 - (A) that AT₂₋₄ Revenue Adjustment Amount; and

- (B) a return on capital amount, calculated by reference to the Discount Rate as applied to the AT₂₋₄ Revenue Adjustment Amount over the period starting on the first day of the Year in which the Revenue Adjustment Amount is calculated and ending on the last day of the Year following that Year; and
- (ii) for an AT₅ Revenue Adjustment Amount, by subtracting from the relevant Second Year Allowable Revenue:
 - (A) that AT₅ Revenue Adjustment Amount; and
 - (B) a return on capital amount, calculated by reference to the Discount Rate as applied to the AT₅ Revenue Adjustment Amount over the period starting on the first day of the Year in which the Revenue Adjustment Amount is calculated and ending on the last day of the Year following that Year.
- (c) Where a Second Year Allowable Revenue is adjusted under this **clause 4.4**, Aurizon Network must vary the relevant Reference Tariff as part of the adjustment of the relevant Reference Tariff under **clause 4.1(a)**.

5 Reference Tariff variations

5.1 Obligation to submit Reference Tariff variations

- (a) Aurizon Network:
 - (i) may submit a Reference Tariff variation to the QCA, where Aurizon Network considers that the variation will promote efficient investment by either Aurizon Network or another person in the Supply Chain; or
 - (ii) must submit a Reference Tariff variation to the QCA, subject to **clause 5.6**:
 - (A) within sixty (60) days after:
 - (1) Aurizon Network becomes aware that an Endorsed Variation Event has occurred or a Review Event has occurred or will occur; or
 - (2) a notice being given to Aurizon Network by the QCA under **clause 5.1(b)**; or
 - (B) by 28 February prior to each Year of the Term, in accordance with **clause 4.1(a)** (if applicable).
- (b) The QCA may give Aurizon Network a notice requiring Aurizon Network to submit a Reference Tariff variation if Aurizon Network fails to submit a Reference Tariff variation within sixty (60) days, subject to

clause 5.6, after the QCA determines, and notifies Aurizon Network, that an Endorsed Variation Event or a Review Event has occurred.

- (c) The QCA may develop a Reference Tariff variation that is consistent with the requirements specified in this **clause 5**:
 - (i) if Aurizon Network does not comply with a written notice given by the QCA under **clause 5.1(b)** or **clause 5.5(e)(ii)** for it to submit, or resubmit, a Reference Tariff variation; or
 - (ii) if the QCA refuses to approve a Reference Tariff variation resubmitted by Aurizon Network in accordance with a notice given by the QCA under **clause 5.5(e)(ii)**.
- (d) A Reference Tariff variation under this **clause 5** will include a revised GtK Forecasts and Allowable Revenues to the extent applicable to that Reference Tariff variation.

5.2 Endorsed Variation Events

The occurrence of any of the following events is an Endorsed Variation Event:

- (a) a Change in Law or a Change in Relevant Taxes occurs, that either alone or in combination with all other Changes in Law or Changes in Relevant Taxes that have occurred since the Commencing Date, would cause a change in the costs reflected in the AT₃, AT₄, and/or AT₅ input of the relevant Reference Tariff of greater than 2.5% excluding the impact of any Change in Law or Change in Relevant Taxes that have previously resulted in a variation of the Reference Tariff;
- (b) any change in the Electric Operating Expenditure Allowance as contemplated in **clause 4.1(c)(ii)** including a change in the pricing of one or more Distribution Entities and/or Transmission Entities that, either alone or in combination with all other changes in the pricing of relevant Distribution Entities and/or Transmission Entities that have occurred since the Commencing Date and that have not previously resulted in a variation of the Reference Tariff, would cause a change in the costs reflected in the AT₅ input of the relevant Reference Tariff of greater than 2.5%;
- (c) the QCA Levy input of a relevant Reference Tariff is reviewed (taking into account any over or under recovery of fees via the QCA Levy component of Access Charges in the previous Year) following the QCA's announcement of its fees for the provision of regulatory services for the rail industry; and
- (d) in the circumstances described in **clause 7A.4.3(f)** of the Undertaking the IE Pass Through Cost for the Year ending 30 June 2021 advised to the QCA in accordance with that clause will constitute an Endorsed Variation Event and will constitute an approved variation to the Reference Tariff for the relevant Year without the need for separate

consultation or approval by the QCA under **clause 5.5** of this **Schedule F**.

5.3 Review Event

The occurrence of a Force Majeure Event – of the type set out in either **paragraph (e), (l) or (m)** of the definition of that term – affecting Aurizon Network, to the extent that Aurizon Network has incurred or will incur additional Incremental Costs of greater than \$1 million that have not previously resulted in a variation of the relevant Reference Tariff, is a Review Event in respect of which Aurizon Network has given written notice to the QCA of Aurizon Network's intention to propose a variation to that Reference Tariff under this **clause 5**.

5.4 Requirements for submissions

Where Aurizon Network submits a Reference Tariff variation, the variation must:

- (a) nominate the Reference Tariff to be varied;
- (b) include details of the methodology, data and assumptions used to vary the Reference Tariff;
- (c) for a variation under **clause 5.1(a)(i)**, include information on:
 - (i) the matters set out in **clause 6.6** (Pricing limits) of this Undertaking; and
 - (ii) why Aurizon Network considers that the variation of the Reference Tariff will promote efficient investment by either Aurizon Network or another person in the Supply Chain; and
- (d) for a variation in respect of an Endorsed Variation Event or a Review Event, evidence that the Endorsed Variation Event or Review Event has occurred or will occur.

5.5 Approval process

- (a) The QCA may publish details of Aurizon Network's proposed Reference Tariff variation and invite and consider comments from stakeholders regarding the proposed variation.
- (b) The QCA must give Aurizon Network a reasonable opportunity to respond to any comments from stakeholders that the QCA considers regarding the proposed variation. The QCA must consider all such responses from Aurizon Network.
- (c) The QCA may approve Aurizon Network's proposed Reference Tariff variation if the QCA is satisfied that:
 - (i) for a variation in respect of an Endorsed Variation Event:
 - (A) the Endorsed Variation Event has occurred; and
 - (B) the variation of the Reference Tariff is consistent with the change in the forecast cost resulting from

- the Endorsed Variation Event (including incremental maintenance and incremental capital costs), calculated as if all other assumptions originally used for the determination of Reference Tariffs are held constant;
- (ii) for a variation in respect of a Review Event:
 - (A) the Review Event has occurred or will occur; and
 - (B) the variation of the relevant Reference Tariff:
 - (1) is consistent with the change in the cost resulting from or that will result from the Review Event; and
 - (2) reflects the impact of the relevant Review Event on the financial position of Aurizon Network (including the impact of incremental maintenance and incremental capital costs); and
 - (iii) for a variation in respect of either an Endorsed Variation Event or a Review Event, whether the proposed variation has been calculated as if all other Reference Tariffs were also being recalculated due to the Endorsed Variation Event or Review Event (as applicable).
 - (d) If the QCA approves a Reference Tariff variation:
 - (i) the QCA will give Aurizon Network a notice stating the reasons for the QCA's decision;
 - (ii) the Reference Tariff variation will apply, where the variation arose as a result of:
 - (A) an Endorsed Variation Event:
 - (1) from the first day of the Month immediately following the date of the occurrence of the Endorsed Variation Event; or
 - (2) where the date of the occurrence of the Endorsed Variation Event is the first day of a Month, from that date;
 - (B) an adjustment of Reference Tariffs under **clause 4.1**, from 1 July of the Year following the Year in which the variation was submitted; or
 - (C) a Review Event, from the date approved by the QCA (being a date that may be before, on or after the date on which the QCA approved that Reference Tariff variation); and

- (iii) Aurizon Network must:
 - (A) publish details of the Reference Tariff variation on the Website; and
 - (B) advise Access Holders and Access Seekers, in respect of the relevant Reference Train Service, of the Reference Tariff variation.
- (e) If the QCA refuses to approve a Reference Tariff variation, the QCA will give Aurizon Network a notice:
 - (i) stating the reasons for its refusal and the way in which the QCA considers that the variation should be amended; and
 - (ii) if that variation was required to be submitted by Aurizon Network under this **clause 5** in respect of an Endorsed Variation Event or a Review Event, requiring Aurizon Network to vary the Reference Tariff in the way the QCA considers it appropriate and to resubmit the variation to the QCA within twenty (20) Business Days after Aurizon Network receiving the notice, subject to **clause 5.6**.
- (f) Aurizon Network must comply with a notice given under **clause 5.5(e)**.
- (g) When considering whether to approve a resubmitted Reference Tariff variation or a Reference Tariff variation developed by the QCA under **clause 5.1(c)**, the QCA must take into account:
 - (i) the matters specified under **clause 5.5(c)** (as applicable); and
 - (ii) if applicable, whether the variation has been amended or developed in accordance with the QCA's prior decision (if any) to refuse to approve the relevant Reference Tariff variation.
- (h) For the purposes of **clause 5.1**:
 - (i) a Reference Tariff variation submitted by Aurizon Network or developed by the QCA under **clause 5.1** must include a review of Allowable Revenue and Gtk Forecast to the extent applicable to that variation; and
 - (ii) the QCA in approving a variation of a Reference Tariff must also approve the corresponding variation of the applicable Allowable Revenue and Gtk Forecast.

5.6 Extensions of time

- (a) The QCA may grant Aurizon Network an extension of the time for submitting, or resubmitting, a Reference Tariff variation if:

- (i) Aurizon Network provides a written request to the QCA for an extension of time which includes the reasons why Aurizon Network requires the extension of time; and
 - (ii) the extension of time is reasonable or necessary.
- (b) If the QCA grants Aurizon Network an extension of time under **clause 5.6(a)**, Aurizon Network must submit or resubmit the Reference Tariff variation within the time specified by the QCA.

6 Adjustment Charges

6.1 Calculation of Adjustment Charges

- (a) Subject to **clause 6.3**, if:
- (i) this Undertaking specifies that a Reference Tariff is applicable or effective from a date prior to the date on which that Reference Tariff was approved by the QCA; or
 - (ii) a variation of a Reference Tariff (including a variation approved under **clause 5**) is applicable or effective from a date prior to the date on which the variation was approved by the QCA,

Aurizon Network is entitled to recover from or will reimburse to, as applicable, each relevant Access Holder (or, if applicable, Train Operator) if it pays a component of the Access Charges the amount (**Adjustment Amount**) which is the sum of:

- (iii) the aggregate of the differences, for each relevant Access Holder (or, if applicable, Train Operator) for each calendar Month (or part thereof) since the date on which the Reference Tariff or the variation of the Reference Tariff was to apply or take effect (**Effective Date**) until the date on which that Reference Tariff was approved by the QCA or the variation of the Reference Tariff was made, as applicable, between:
 - (A) the Access Charges paid or payable by that Access Holder (or, if applicable, Train Operator) in respect of the Train Services operated by or for that Access Holder (or, if applicable, Train Operator) during that calendar Month (or part thereof); and
 - (B) the Access Charges that would have been paid or payable by that Access Holder (or, if applicable, Train Operator) in respect of those Train Services if the Access Charges were calculated in accordance with the Reference Tariff or the variation of the Reference Tariff referred to in **clause 6.1(a)(i)** or **(ii)** on and from the Effective Date; and

- (iv) the aggregate of the interest calculated in accordance with **clause 6.1(b)** in respect of the amount of each difference comprising the amount calculated in accordance with **clause 6.1(a)(iii)**,

by making adjustments to the Access Charges (**Adjustment Charge**) payable by Access Holders (or, if applicable, Train Operator if it pays a component of the Access Charges so as to recover or reimburse, as applicable, the Adjustment Amount (subject to the provisions of this Undertaking). To the extent that the Access Holder (or, if applicable, Train Operator) has not paid the original Access Charge to which an Adjustment Charge relates, then the Adjustment Charge may be set off against the amount payable by the Access Holder (or, if applicable, Train Operator).

- (b) The interest referred to in **clause 6.1(a)(iv)** must be calculated:
 - (i) in respect of the amount of each difference comprising the amount calculated under **clause 6.1(a)(iii)**;
 - (ii) on the basis that the interest:
 - (A) accrues and is charged from day to day; and
 - (B) is capitalised at the end of each Month and will thereafter itself bear interest;
 - (iii) at the rate equal to, for interest accruing in a Month:
 - (A) the mid-point of the one Month Bank Bill Swap Rate as published by the Australian Financial Markets Association (or its successor) for the Business Day immediately prior to the 21st day of the previous Month; or
 - (B) if that rate is no longer published, the rate will be an appropriate equivalent rate determined by Aurizon Network, acting reasonably; and
 - (iv) for the period commencing on the date when the Access Charges used to calculate the applicable difference in accordance with **clause 6.1(a)(iii)(A)** were due and payable and ending on the date when the Adjustment Charge is to be due and payable,

provided that if Aurizon Network is required to reimburse an Adjustment Charge, then no interest will be calculated to the extent that the Access Holder (or, if applicable, Train Operator) has not paid the original Access Charge to which the Adjustment Charge relates.

6.2 Approval of Adjustment Charges

- (a) Aurizon Network:
 - (i) may, if it submits a Reference Tariff variation under **clause 5.1** and that variation is proposed to apply or take

effect on a date prior to the date on which the QCA will approve the variation; or

- (ii) must, if:
 - (A) the QCA approves a Reference Tariff variation under **clause 5.1** and that variation applies or takes effect on a date prior to the date on which the QCA approves the variation (and subject to **clause 6.2(a)(i)**); or
 - (B) this Undertaking specifies that a Reference Tariff is applicable or effective from a date prior to the date on which that Reference Tariff was approved by the QCA,

submit to the QCA proposed Adjustment Charges within 60 days after the date of the relevant QCA approval.

- (b) Where Aurizon Network submits proposed Adjustment Charges to the QCA under **clause 6.2(a)**:

- (i) Aurizon Network's submission must, without limitation:
 - (A) identify, subject to **clause 6.3(a)**, the Access Holders (or, if applicable, Train Operator) in respect of whom the proposed Adjustment Charges are to be applied;
 - (B) set out the proposed Adjustment Charges for each Access Holder (or, if applicable, Train Operator) including details of how those proposed Adjustment Charges were calculated;
 - (C) indicate the Billing Period(s) in respect of which the proposed Adjustment Charges are to be applied; and
 - (D) if applicable, how the proposed Adjustment Charges are to be allocated for the purposes of calculations under **clause 4.3**;
- (ii) if the QCA considers it appropriate, the QCA may publish details of Aurizon Network's submission of proposed Adjustment Charges and invite and consider comments from stakeholders regarding the proposed Adjustment Charges; and
- (iii) the QCA must approve:
 - (A) the Access Holders (and, if applicable, Train Operators) in respect of whom the Adjustment Charges are to apply;
 - (B) the Adjustment Charges that are to apply to each Access Holder (and, if applicable, Train Operator);

- (C) the Billing Period(s) in respect of which the Adjustment Charges will be applied; and
- (D) if applicable, how the Adjustment Charges must be allocated for the purposes of calculations under **clause 4.3**,

if the proposed Adjustment Charges submitted by Aurizon Network (excluding any interest component) constitute no more of a recovery or no less of a reimbursement of any under or over recovery of Access Charges by Aurizon Network that relate to each Access Holder (or, if applicable, Train Operator), and any interest component was calculated under **clause 6.1(b)(iii)**.

- (c) Aurizon Network must comply with an approval of the QCA given under **clause 6.2(b)(iii)** or **6.2(f)** including in applying the Adjustment Charge approved for each Access Holder to the calculation of Access Charges payable by that Access Holder (or, if applicable, Train Operator).
- (d) If the QCA refuses to approve Aurizon Network's submission for an Adjustment Charge, the QCA must give Aurizon Network a notice:
 - (i) stating the reasons for its refusal and the way in which the QCA considers the proposed Adjustment Charge should be amended so as to constitute (excluding any interest component) no more of a recovery or no less of a reimbursement of any under or over recovery of Access Charges by Aurizon Network that relate to each Access Holder (or, if applicable, Train Operator); and
 - (ii) requiring Aurizon Network to vary the proposed Adjustment Charge in the way the QCA considers it appropriate and resubmit the amended proposal to the QCA within thirty (30) days of Aurizon Network receiving the notice.
- (e) Aurizon Network must comply with a notice given under **clause 6.2(d)**.
- (f) The QCA must approve a resubmitted proposal for Adjustment Charges, if the resubmitted proposal has been amended or developed in accordance with the QCA's notice given under **clause 6.2(d)** and the QCA is satisfied that the proposed Adjustment Charges resubmitted by Aurizon Network (excluding any interest component) constitute no more of a recovery or no less of a reimbursement of any under or over recovery of Access Charges by Aurizon Network that relate to each Access Holder (or, if applicable, Train Operator).

6.3 Application to Access Holders and Train Operators

- (a) An Adjustment Charge may only apply to:

- (i) an Access Holder (**New Access Holder**) that did not run, or cause a Train Operator to run; or
- (ii) a Train Operator (**New Train Operator**) that did not operate, the Train Services to which that Adjustment Charge relates (**Past Train Services**) if:
 - (iii) the Access Holder who ran (or caused a Train Operator to run) or the Train Operator who operated (as applicable), the Past Train Services no longer has (or, at the time when the Adjustment Charges are to be applied, will have ceased to have) a rail haulage agreement with the Customer relating to the Past Train Services or in respect of Train Services with the same origin and destination as the Past Train Services;
 - (iv) either:
 - (A) the New Access Holder or New Train Operator (as applicable) has a rail haulage agreement with the person who was the Customer referred to in **clause 6.3(a)(iii)** (including that Customer's successors and assigns) in respect of Train Services with the same origin and destination as the Past Train Services; or
 - (B) the New Access Holder was that Customer (or is that Customer's successor or assign); and
 - (v) either:
 - (A) for a New Access Holder, the New Access Holder has been granted Access Rights with the same origin and destination as the Past Train Services; or
 - (B) for a New Train Operator, the New Train Operator's Train Operations Deed includes right to operate Train Services with the same origin and destination as the Past Train Services.
- (b) No Adjustment Charge will apply to an Access Holder who ran the Past Train Services if that Access Holder has, at the time when the Adjustment Charges are to be applied, ceased to have a rail haulage agreement with the Customer for the Past Train Services (including that person's successors and assigns) in respect of Train Services with the same origin and destination as the Past Train Services provided that with the cessation of that rail haulage agreement, the applicable Access Rights were either relinquished or expired.
- (c) For clarity:
 - (i) where:
 - (A) an Access Holder does not have a Train Operator; and

- (B) if that Access Holder had a Train Operator, Adjustment Charges would be applied to that Train Operator in accordance with **clause 6.2(a)**,
any such Adjustment Charge will apply to the Access Holder;
or
- (ii) where:
 - (A) a Past Train Service was or was entitled to be operated under an Access Agreement by a relevant Train Operator (**Past Train Operator**);
 - (B) there is no New Access Holder; and
 - (C) either the Access Holder, at the time when the Adjustment Charges are to be applied:
 - (1) does not have a Train Operator under that Access Agreement; or
 - (2) has a Train Operator but that person is not the Past Train Operator,
 any such Adjustment Charge will:
 - (D) if there is no Train Operator, apply to the Access Holder; or
 - (E) otherwise, apply to the relevant Train Operator.
- (d) The calculation of Access Charges under an Access Agreement must be reviewed and varied to provide for the payment of Adjustment Charges in respect of the relevant Access Holder (or, if applicable, Train Operator) including:
 - (i) that the Access Charges payable by the Access Holder (or, if applicable, Train Operator) must include any applicable Adjustment Charge from time to time in relation to or in connection with any variation of a Reference Tariff that applies or takes effect on a past date or any Reference Tariff that this Undertaking states is applicable or effective from a past date; and
 - (ii) that an Adjustment Charge must be applied to the calculation of the amount of the invoice for charges payable by the Access Holder (or, if applicable, Train Operator) under the Access Agreement for the relevant Billing Period.

7 Blackwater System – System Reference Tariff

7.1 Additional Reference Train Service criteria

In addition to **clause 1.3**, the Reference Train Service to which this **clause 7** applies must also satisfy the following criteria:

- (a) **(Coal System)** operates in the Blackwater System;
- (b) **(Operational characteristics)** meets the following criteria:
 - (i) a maximum Comparative Length of 1716 metres;
 - (ii) a maximum axle load of 26.5 tonne for a wheel configuration consistent with M220⁹ loading, or otherwise generates a loading equivalent to M220, except that Train Services operating from Minerva will have a maximum axle load of 20 tonne – with loading in excess of this maximum axle load dealt with in accordance with the relevant Load Variation Table; and
 - (iii) uses diesel or electric traction, except operating from Minerva where it will only use diesel traction.
- (c) **(Conditions of Access)** where its Access Agreement has an “Average Below Rail Transit Time Threshold” (as defined under the relevant Standard Access Agreement) or another equivalent threshold or performance level relating to Aurizon Network (**Threshold**) and that Threshold is no less than 127%;
- (d) **(Loading Facilities)** uses the following Nominated Loading Facilities and does not exceed the following Loading Times:

Nominated Loading Facilities ¹⁰	Loading Time (hours) per return trip
Yarrabee (Boonal)	3.8
Jellinbah (Boonal)	4.6
Boorgoon	3.8
Curragh	3.3
Ensham	3.2
Gregory	3.0
Kestrel (Gordonstone)	3.3
Kinrola	3.15
Koorilgah	5.0
Minerva	2.3

⁹ As specified in the ANZRC Railway Bridge Design Manual 1974.

¹⁰ Diagrams showing the location of the Nominated Loading Facilities for a nominated Reference Train Service are included in the Preliminary Information for the relevant Coal System.

Nominated Loading Facilities ¹⁰	Loading Time (hours) per return trip
Meteor Downs	5.0 [^]
Rolleston	4.3
Yongala	3.2

[^] Loading time will be determined following 3 months of continual operation

- (e) **(Unloading Facilities)** uses the following Nominated Unloading Facilities and does not exceed the following Unloading Times:

Nominated Unloading Facilities ¹¹	Unloading Time (hours) per return trip
Barney Point	5.0
Cement Australia	6.0
Comalco Refinery	6.0
Gladstone Power Station	4.3
Golding/RG Tanna Terminal	2.6
Queensland Alumina Ltd (QAL) ¹²	8.9
Stanwell Power Station	2.3
Wiggins Island Coal Export Terminal	1.5 ¹³

- (f) **(Dwell Period)** has Dwell periods not exceeding the following:

	Dwell period (hours) per return trip
Inclusive of Train examination	9.2
Excluding Train examination	3.2

7.2 Reference Tariff inputs

- (a) Subject to **clause 7.2(c)**, the Reference Tariff inputs are:

¹¹ Diagrams showing the location of the Nominated Unloading Facilities for a nominated Reference Train Service are included in the Preliminary Information for the relevant Coal System.

¹² The Unloading Time for the QAL refinery represents the time the Train Service is off the Rail Infrastructure on the relevant Private Infrastructure.

¹³ For services from the North Coast Line 0.7 hours.

Reference Tariff input	2017/18 [^] (\$)	2018/19 [^] (\$)	2019/20 [^] (\$)	2020/21 (\$)	2021/22 [^] (\$)	2022/23 (\$)
AT ₁	0.92	0.93	0.95	0.97	0.99	1.01
AT ₂	2,161.22	2,264.88	2,318.56	2,373.51	2,429.76	2,487.34
AT ₃	6.81*	6.62*	7.34*	6.96*	6.737.18*	6.366.33*
AT ₄	2.41	2.22	2.62	2.48	2.382.56	2.262.25
AT ₅	3.09	2.58	2.97	2.83	2.762.98	2.782.85
EC	1.01	0.79	0.86	0.82	0.990.83	0.92
QCA Levy	0.03961	0.00907	0.00998	0.00~	0.009790.003 27	0.00993
IE Fee	N/A	N/A	N/A	0.01812	0.01485	

* This amount must be adjusted by subtracting the System Discount under **clause 7.2(b)** where the System Discount, applies to the relevant Train Service.

[^] 2017/18, 2018/19, ~~and 2019/20~~ and 2021/22 Reference Tariffs include the impact of 2015/16, 2016/17, ~~and 2017/18~~ and 2019/20 Revenue Adjustment Amounts respectively. 2019/20 Reference Tariffs also include the impact of the 2018/19 Revenue Adjustment Amounts.

~ On 20 August 2020, the QCA approved an updated QCA Levy of \$nil to apply from 1 September 2020 to 30 June 2021. For clarity, the annualised QCA Levy for 2020/21 is \$0.00091/nt.

(b) The System Discounts for Train Services to or from Nominated Loading Facilities or Nominated Unloading Facilities are:

Nominated Unloading Facilities	System Discount (\$/ntk)					
	2017/18 [^]	2018/19 [^]	2019/20 [^]	2020/21	2021/22 [^]	2022/23
Stanwell Power Station	2.28	2.27	2.46	2.40	2.322.42	2.202.18

[^] 2017/18, 2018/19, ~~and 2019/20~~ and 2021/22 Reference Tariffs include the impact of 2015/16, 2016/17, ~~and 2017/18~~ and 2019/20 Revenue Adjustment Amounts respectively. 2019/20 Reference Tariffs also include the impact of the 2018/19 Revenue Adjustment Amounts.

(c) The Reference Tariff inputs referred to below in relation to a Nominated Loading Facility replace the equivalent Reference Tariff inputs in **clause 7.2(a)** for any Train Service using that Nominated Loading Facility:

Nominated Loading Facility	Reference Tariff input	2017/18 (\$)^	2018/19 (\$)^	2019/20 (\$)^	2020/21 (\$)	2021/22 (\$)^	2022/23 (\$)
Rolleston*	AT ₃	6.81	7.58	7.34	6.96	6.737.18	6.366.33
Minerva	AT ₃	6.81	10.77	7.34	6.96	6.737.18	6.366.33
Meteor Downs South	AT ₃						5.165.15
	AT ₄						1.762.05

* Includes non-WIRP and WIRP Rolleston.

^ 2017/18, 2018/19, ~~and 2019/20~~ and 2021/22 Reference Tariffs include the impact of 2015/16, 2016/17, ~~and 2017/18~~ and 2019/20 Revenue Adjustment Amounts respectively. 2019/20 Reference Tariffs also include the impact of the 2018/19 Revenue Adjustment Amounts.

- (d) The Reference Tariff inputs referred to below is an Expansion Tariff applicable to the Meteor Downs Nominated Unloading Facility and replace the equivalent Reference Tariff inputs in **clause Schedule F7.2(a)7.2(a)**:

Reference Tariff Input	2020/21 (\$)^	2021/22 (\$)^
AT ₁	0.97	0.99
AT ₂	2,373.51	2,429.76
AT ₃	4.70	4.454.01
AT ₄	2.45	2.352.47

^ The Expansion Tariff applies for the period of 1 July 2020 to 30 June 2022.

- (e) For clarity, where a Train Service operating in the Blackwater System is a Cross System Train Service, the Reference Tariff inputs set out above relating to that Train Service are subject to **clause 2.3**.
- (f) The Nominal Train Payload for:
- (i) a Train Service (other than a Cross System Train Service or a Train Service referred to in **clause 7.2(f)(e)(iii)**) to which the Reference Tariff in this **clause 7** applies, is a nominal nt of 8,369 tonnes;
 - (ii) a Cross System Train Service where the Destination System is the Blackwater System, is a nominal nt of 8,369 tonnes; or

- (iii) a Train Service (other than a Cross System Train Service) that has Minerva as a Nominated Loading Facility, is a nominal nt of 5,831 tonnes.

7.3 Gtk Forecast and Allowable Revenues

- (a) The GTK Forecasts for the System Reference Tariffs and the Expansion Tariffs are:

Year	Gtk Forecast (,000 gtk)	Expansion Tariff Gtk Forecast
2017/18 ¹	38,721,726	
2018/19 ¹	35,943,120	
2019/20 ¹	37,419,135	
2020/21	37,125,662	1,063,308
2021/22	38,876,324 <u>34,883,023</u>	1,063,308 <u>841,786</u>
2022/23	40,440,684	

(1) For clarity the Gtk Forecast applies on to System Reference Tariffs and the Expansion Tariff is not a System Reference Tariff for the purpose of calculating Take or Pay amounts.

- (b) The Allowable Revenue for the System Reference Tariffs and the Expansion Tariffs are:

Year	Allowable Revenue – AT _{2,4} (\$000)	Allowable Revenue – AT ₅ (\$000)
2017/18 ¹	356,451	91,215
2018/19 ¹	333,069	72,915
2019/20 ¹	374,844	80,567
2020/21	363,837 ²	76,011
2021/22 ¹	370,948 <u>352,189</u> ²	78,750 <u>75,048</u>
2022/23	359,037 <u>357,877</u>	80,250 <u>82,415</u>

(1) 2017/18, 2018/19, ~~and~~ 2019/20 and 2021/22 Reference Tariffs include the impact of 2015/16, 2016/17, ~~and~~ 2017/18 and 2019/20 Revenue Adjustment Amounts respectively. 2019/20 Allowable Revenues also include the impact of the 2018/19 Revenue Adjustment Amounts.

(2) For clarity the Allowable Revenue is inclusive of the Allowable Revenue for both the System Reference Tariffs and the Expansion Tariff.

8 Goonyella System – System Reference Tariff

8.1 Additional Reference Train Service criteria

In addition to **clause 1.3**, the Reference Train Service to which this **clause 8** applies must also satisfy the following criteria:

- (a) **(Coal System)** operates in the Goonyella System;
- (b) **(Operational characteristics)** meets the following criteria:
 - (i) a maximum Comparative Length of 2082 metres;
 - (ii) a maximum axle load of 26.5 tonne for a wheel configuration consistent with M220¹⁴ loading, or otherwise generates a loading equivalent to M220 – with loading in excess of this maximum axle load dealt with in accordance with the relevant Load Variation Table; and
 - (iii) uses diesel or electric traction.
- (c) **(Conditions of Access)** where its Access Agreement has an “Average Below Rail Transit Time Threshold” (as defined under the relevant Standard Access Agreement) or another equivalent threshold or performance level relating to Aurizon Network (**Threshold**) and that Threshold is no less than 123%;
- (d) **(Loading Facilities)** uses the following Loading Facilities and does not exceed the following Loading Times:

Nominated Loading Facilities ¹⁵	Loading Time (hours) per return trip
Blair Athol (Clermont)	3.1
Burton	3.8
Carborough Downs	3.5
Caval Ridge*	2.5
German Creek	2.9
Goonyella	3.9
Gregory	3.6

¹⁴ As specified in the ANZRC Railway Bridge Design Manual 1974.

¹⁵ Diagrams showing the location of the Nominated Loading Facilities for a nominated Reference Train Service are included in the Preliminary Information for the relevant Coal System.

Nominated Loading Facilities¹⁵	Loading Time (hours) per return trip
Hail Creek	2.6
Isaac Plains	3.9
Lake Vermont	3.0
Macarthur (Coppabella)	3.9
Millennium	3.0
Middlemount*	3.5
Moorvale	3.6
Moranbah North	3.6
North Goonyella	4.3
Norwich Park	3.9
Oaky Creek	3.2
Peak Downs	4.2
Riverside	4.6
Saraji	4.4
South Walker Creek	3.8

* Balloon loops for these loading facilities are Private Infrastructure

(e) **(Unloading Facilities)** uses the following Nominated Unloading Facilities and does not exceed the following Unloading Times:

Nominated Unloading Facilities¹⁶	Unloading Time (hours) per return trip
Dalrymple Bay	Pit 1 – 2.5 Pit 2 – 2.5 Pit 3 – 2.0
Hay Point	2.8

(f) **(Dwell Period)** has Dwell periods not exceeding the following:

¹⁶ Diagrams showing the location of the Nominated Unloading Facilities for a nominated Reference Train Service are included in the Preliminary Information for the relevant Coal System.

	Dwell period (hours) per return trip
Inclusive of Train examination	8.8
Excluding Train examination	1.8

8.2 Reference Tariff inputs

(a) Subject to **clause 8.2(b)**, the Reference Tariff inputs are:

Reference Tariff input	2017/18^ (\$)	2018/19^ (\$)	2019/20^ (\$)	2020/21 (\$)	2021/22^ (\$)	2022/23 (\$)
AT ₁	0.63	0.65	0.66	0.67	0.68	0.70
AT ₂	1,369.26	1,434.93	1,468.94	1,503.76	1,539.39	1,575.88
AT ₃	5.22	4.87	4.81	4.86	4.535.09	4.414.45
AT ₄	1.08	0.99	0.99	0.99	0.931.03	0.940.92
AT ₅	2.30	1.40	1.54	1.68	1.651.97	1.701.72
EC	1.01	0.79	0.86	0.82	0.900.83	0.92
QCA Levy	0.03961	0.00907	0.00998	0.00~	0.009790.00 327	0.00993
IE Fee	N/A	N/A	N/A	0.01812	0.01485	

^ 2017/18, 2018/19, ~~and~~ 2019/20 ~~and~~ 2021/22 Reference Tariffs include the impact of 2015/16, 2016/17, ~~and~~ 2017/18 ~~and~~ 2019/20 Revenue Adjustment Amounts respectively. 2019/20 Reference Tariffs also include the impact of the 2018/19 Revenue Adjustment Amounts.

~ On 20 August 2020, the QCA approved an updated QCA Levy of \$nil to apply from 1 September 2020 to 30 June 2021. For clarity, the annualised QCA Levy for 2020/21 is \$0.00091/nt.

(b) The Reference Tariff inputs referred to below in relation to a Nominated Loading Facility replace the equivalent Reference Tariff inputs in **clause 8.2(a)** for any Train Service using that Nominated Loading Facility:

Nominated Loading Facility	Reference Tariff input	2017/18^ (\$)	2018/19^ (\$)	2019/20^ (\$)	2020/21 (\$)	2021/22^ (\$)	2022/23 (\$)
Middlemount	AT ₃	1.15	3.20	3.28	3.70	2.983.60	3.00
	AT ₄	0.31	0.85	0.99	0.99	0.800.97	0.80
	AT ₅	0.64	0.52	0.46	0.58	0.990.80	0.990.91

Nominated Loading Facility	Reference Tariff input	2017/18 [^] (\$)	2018/19 [^] (\$)	2019/20 [^] (\$)	2020/21 (\$)	2021/22 [^] (\$)	2022/23 (\$)
Caval Ridge	AT ₃	2.49	3.54	3.37	3.63	3.463.96	3.043.07
	AT ₄	0.51	0.72	0.70	0.74	0.660.80	0.630.64
	AT ₅	1.73	1.08	1.20	1.39	1.301.66	1.34

[^] 2017/18, 2018/19, ~~and 2019/20~~ and 2021/22 Reference Tariffs include the impact of 2015/16, 2016/17, ~~and 2017/18~~ and 2019/20 Revenue Adjustment Amounts respectively. 2019/20 Reference Tariffs also include the impact of the 2018/19 Revenue Adjustment Amounts.

(c) For clarity, where a Train Service operating in the Goonyella System is a Cross System Train Service, the Reference Tariff inputs set out above relating to that Train Service are subject to **clause 2.3**.

(d) The Nominal Train Payload for:

(i) a Train Service (other than a Cross System Train Service) to which the Reference Tariff in this **clause 8** applies; or

(ii) a Cross System Train Service where the Destination System is the Goonyella System,

is a nominal nt of 10,236 tonnes.

8.3 Gtk Forecast and Allowable Revenues

Year	Gtk Forecast (,000 gtk)	Allowable Revenue – AT ₂₋₄ (\$000)	Allowable Revenue – AT ₅ (\$000)
2017/18 ¹	37,598,102	263,647	84,696
2018/19 ¹	40,173,907	280,114	51,706
2019/20 ¹	40,899,252	284,298	60,298
2020/21	40,176,589	282,606	64,654
2021/22 ¹	42,883,758 <u>37,733,317</u>	284,077 <u>277,236</u>	68,240 <u>71,518</u>
2022/23	42,978,021	279,300 <u>281,035</u>	70,179 <u>71,132</u>

(1) 2017/18, 2018/19, ~~and 2019/20~~ and 2021/22 Reference Tariffs include the impact of 2015/16, 2016/17, ~~and 2017/18~~ and 2019/20 Revenue Adjustment Amounts respectively. 2019/20 Allowable Revenues also include the impact of the 2018/19 Revenue Adjustment Amounts.

9 Moura System – System Reference Tariff

9.1 Additional Reference Train Service criteria

In addition to **clause 1.3**, the Reference Train Service to which this **clause 9** applies must also satisfy the following criteria:

- (a) **(Coal System)** operates in the Moura System;
- (b) **(Operational characteristics)** meets the following criteria:
 - (i) a maximum Comparative Length of 1716 metres unless operating from the Nominated Loading Facility of Callide or the Nominated Unloading Facility of QAL, where it will be 1000 metres;
 - (ii) a maximum axle load of 26.5 tonne for a wheel configuration consistent with M220¹⁷ loading, or otherwise generates a loading equivalent to M220 – with loading in excess of this maximum axle load dealt with in accordance with the relevant Load Variation Table; and
 - (iii) uses diesel traction;
- (c) **(Conditions of Access)** where its Access Agreement has an “Average Below Rail Transit Time Threshold” (as defined under the relevant Standard Access Agreement) or another equivalent threshold or performance level relating to Aurizon Network (**Threshold**) and that Threshold is no less than 130%;
- (d) **(Loading Facilities)** uses the following Nominated Loading Facilities and does not exceed the following Loading Times:

Nominated Loading Facilities ¹⁸	Loading Time (hours) per return trip
Baralaba	4.9
Boundary Hill	3.4
Dunn Creek (Callide)	4.2
Moura	3.6

- (e) **(Unloading Facilities)** uses the following Nominated Unloading Facilities and does not exceed the following Unloading Times:

¹⁷ As specified in the ANZRC Railway Bridge Design Manual 1974.

¹⁸ Diagrams showing the location of the Nominated Loading Facilities for a nominated Reference Train Service are included in the Preliminary Information for the relevant Coal System.

Nominated Unloading Facilities ¹⁹	Unloading Time (hours) per return trip
Barney Point	5.0
Cement Australia	4.3
Comalco Refinery	6.0
Gladstone Power Station	4.3
Golding/RG Tanna Terminal	2.6
Queensland Alumina Ltd (QAL) ²⁰	8.9
Wiggins Island Coal Export Terminal	1.5 ²¹

(f) **(Dwell Period)** has Dwell periods not exceeding the following:

	Dwell period (hours)per return trip
Inclusive of Train examination	6.2
Excluding Train examination	3.2

9.2 Reference Tariff inputs

(a) The Reference Tariff inputs are:

Reference Tariff input	2017/18 [^] (\$)	2018/19 [^] (\$)	2019/20 [^] (\$)	2020/21 (\$)	2021/22 [^] (\$)	2022/23 (\$)
AT ₁	1.70	1.73	1.77	1.80	1.84	1.87
AT ₂	647.37	670.79	686.69	702.97	719.63	736.68
AT ₃	9.00	7.27	7.71	8.62	7.54 11.11	7.32 7.41
AT ₄	1.43	1.19	1.25	1.40	1.22 1.80	1.19 1.20
QCA Levy	0.03961	0.00907	0.00998	0.00 [~]	0.009790 00327	0.00993
IE Fee	N/A	N/A	N/A	0.01812	<u>0.01485</u>	

¹⁹ Diagrams showing the location of the Nominated Unloading Facilities for a nominated Reference Train Service are included in the Preliminary Information for the relevant Coal System.

²⁰ The Unloading Time for the QAL refinery represents the time the Train Service is off the Rail Infrastructure on the relevant Private Infrastructure.

²¹ For services from the North Coast Line 0.7 hours.

^ 2017/18, 2018/19, ~~and 2019/20~~ and 2021/22 Reference Tariffs include the impact of 2015/16, 2016/17, ~~and 2017/18~~ and 2019/20 Revenue Adjustment Amounts respectively. 2019/20 Reference Tariffs also include the impact of the 2018/19 Revenue Adjustment Amounts.

~ On 20 August 2020, the QCA approved an updated QCA Levy of \$nil to apply from 1 September 2020 to 30 June 2021. For clarity, the annualised QCA Levy for 2020/21 is \$0.00091/nt.

- (b) For clarity, where a Train Service operating in the Moura System is a Cross System Train Service, the Reference Tariff inputs set out above relating to that Train Service are subject to **clause 2.3**.
- (c) The Nominal Train Payload for:
 - (i) a Train Service (other than a Cross System Train Service or a Train Service referred to in **clause 9.2(c)(iii)**) to which the Reference Tariff in this **clause 9** applies; is a nominal nT of 8,379 tonnes; or
 - (ii) a Cross System Train Service where the Destination System is the Moura System, is a nominal nT of 8,379 tonnes; or,
 - (iii) a Train Service (other than a Cross System Train Service) that has Callide as a Nominated Loading Facility or QAL as a Nominated Unloading Facility, is a nominal nt of 4,955 tonnes.

9.3 Gtk Forecast and Allowable Revenues

Year	Gtk Forecast (,000 gtk)^	Allowable Revenue – AT ₂₋₄ (\$000)^
2017/18 ¹	3,229,725	36,748
2018/19 ¹	3,928,807	38,768
2019/20 ¹	4,294,067	44,908
2020/21	4,294,067	49,879
2021/22 ¹	4,504,019 <u>3,538,134</u>	46,292 <u>51,928</u>
2022/23	4,721,773	47,367 <u>47,900</u>

^ 2017/18, 2018/19, ~~and 2019/20~~ and 2021/22 Reference Tariffs include the impact of 2015/16, 2016/17, ~~and 2017/18~~ and 2019/20 Revenue Adjustment Amounts respectively. 2019/20 Allowable Revenues also include the impact of the 2018/19 Revenue Adjustment Amounts.

^ includes WIRP NCL

10 Newlands System – System Reference Tariff

10.1 Additional Reference Train Service criteria

In addition to **clause 1.3**, the Reference Train Service to which this **clause 10** applies must also satisfy the following criteria:

- (a) **(Coal System)** operates in the Newlands System;
- (b) (Operational characteristics) meets the following criteria:
 - (i) a maximum Comparative Length of 1402 metres;
 - (ii) a maximum axle load of 26.5 tonne for a wheel configuration consistent with M220²² loading, or otherwise generates a loading equivalent to M220 – with loading in excess of this maximum axle load dealt with in accordance with the relevant Load Variation Table; and
 - (iii) uses diesel traction;
- (c) **(Conditions of Access)** where its Access Agreement has an “Average Below Rail Transit Time Threshold” (as defined under the relevant Standard Access Agreement) or another equivalent threshold or performance level relating to Aurizon Network (**Threshold**) and that Threshold is no less than 160%;
- (d) **(Loading Facilities)** uses the following Nominated Loading Facilities and does not exceed the following Loading Times:

Nominated Loading Facilities ²³	Loading Time (hours) per return trip
McNaughton	1.85
Newlands	2.05
Sonoma	2.4
<u>Galilee Connection</u>	<u>To Be Confirmed</u>

- (e) **(Unloading Facilities)** uses the following Nominated Unloading Facilities and does not exceed the following Unloading Times:

Nominated Unloading Facilities ²⁴	Unloading Time (hours) per return trip
Abbot Point	2.05

²² As specified in the ANZRC Railway Bridge Design Manual 1974.

²³ Diagrams showing the location of the Nominated Loading Facilities for a nominated Reference Train Service are included in the Preliminary Information for the relevant Coal System.

²⁴ Diagrams showing the location of the Nominated Unloading Facilities for a nominated Reference Train Service are included in the Preliminary Information for the relevant Coal System.

(f) **(Dwell Period)** has Dwell periods not exceeding the following:

	Dwell period (hours)per return trip
Inclusive of Train examination	6.4
Excluding Train examination	2.4

10.2 Reference Tariff inputs

(a) The Reference Tariff inputs are:

Reference Tariff input	2017/18 [^] (\$)	2018/19 [^] (\$)	2019/20 [^] (\$)	2020/21 (\$)	2021/22 [^] (\$)	2022/23 (\$)
AT ₁	1.77	1.81	1.84	1.88	1.91	1.95
AT ₂	289.45	303.33	310.52	317.88	325.41	333.12
AT ₃	10.06	2.82	4.69	9.25	9.298.78	9.469.86
AT ₄	1.51	0.36	0.60	1.18	1.481.11	1.201.25
QCA Levy	0.03961	0.00907	0.00998	0.00 [~]	0.009790.00 327	0.00993
IE Fee	N/A	N/A	N/A	0.01812	0.01485	

[^] 2017/18, 2018/19, ~~and 2019/20~~ and 2021/22 Reference Tariffs include the impact of 2015/16, 2016/17, ~~and 2017/18~~ and 2019/20 Revenue Adjustment Amounts respectively. 2019/20 Reference Tariffs also include the impact of the 2018/19 Revenue Adjustment Amounts.

[~] On 20 August 2020, the QCA approved an updated QCA Levy of \$nil to apply from 1 September 2020 to 30 June 2021. For clarity, the annualised QCA Levy for 2020/21 is \$0.00091/nt.

(b) For clarity, where a Train Service operating in the Newlands System is a Cross System Train Service, the Reference Tariff inputs set out above relating to that Train Service are subject to **clause 2.3**.

(c) The Nominal Train Payload for:

- (i) a Train Service (other than a Cross System Train Service) to which the Reference Tariff in this **clause 10** applies; or
- (ii) a Cross System Train Service where the Destination System is the Newlands System,

is a nominal nt of 6,864 tonnes.

10.3 Gtk Forecast and Allowable Revenues

Year	Gtk Forecast (,000 gtk)	Allowable Revenue – AT ₂₋₄ (\$000)
2017/18 ¹	2,168,826	27,487
2018/19 ¹	2,582,629	10,125
2019/20 ¹	2,691,284	16,952
2020/21	2,691,284	32,260
2021/22 ¹	2,691,284 3,111,415	32,450 34,058
2022/23	2,691,284	33,035 34,390

(1) 2017/18, 2018/19, ~~and 2019/20~~ and 2021/22 Reference Tariffs include the impact of 2015/16, 2016/17, ~~and 2017/18~~ and 2019/20 Revenue Adjustment Amounts respectively. 2019/20 Allowable Revenues also include the impact of the 2018/19 Revenue Adjustment Amounts.

11 Goonyella to Abbot Point System – System Reference Tariff

11.1 Additional Reference Train Service criteria

In addition to **clause 1.3**, the Reference Train Service to which this **clause 11** applies must also satisfy the following criteria:

- (a) **(Coal System)** operates in the Goonyella to Abbot Point System;
- (b) (Operational characteristics) meets the following criteria:
 - (i) a maximum Comparative Length of 1402 metres;
 - (ii) a maximum axle load of 26.5 tonne for a wheel configuration consistent with M220²⁵ loading, or otherwise generates a loading equivalent to M220 – with loading in excess of this maximum axle load dealt with in accordance with the relevant Load Variation Table; and
 - (iii) uses diesel traction.
- (c) **(Conditions of Access)** where its Access Agreement has an “Average Below Rail Transit Time Threshold” (as defined under the relevant Standard Access Agreement) or another equivalent threshold or performance level relating to Aurizon Network (**Threshold**) and that Threshold is no less than 160%;

²⁵ As specified in the ANZRC Railway Bridge Design Manual 1974.

- (d) **(Loading Facilities)** uses the following Nominated Loading Facilities and does not exceed the following Loading Times:

Nominated Loading Facilities ²⁶	Loading Time (hours) per return trip
Riverside	3.0
Peak Downs	3.0
Lake Vermont	2.05 (estimate) ²⁷
Blair Athol (Clermont)	2.04 (estimate) ²⁸
Middlemount*	2.75
Caval Ridge*	1.85
Millenium	3.0
Goonyella	3.0

* Balloon loops for these loading facilities are Private Infrastructure.

- (e) **(Unloading Facilities)** uses the following Nominated Unloading Facilities and does not exceed the following Unloading Times:

Nominated Unloading Facilities ²⁹	Unloading Time (hours) per return trip
Abbot Point	2.05

- (f) **(Dwell Period)** has Dwell periods not exceeding the following:

	Dwell period (hours)per return trip
Inclusive of Train examination	7.35 per consist every 20 days
Excluding Train examination	1.35

11.2 Reference Tariff inputs

- (a) The Reference Tariff inputs are:

²⁶ Diagrams showing the location of the Nominated Loading Facilities for a nominated Reference Train Service are included in the Preliminary Information for the relevant Coal System.

²⁷ This is an estimate of loading time for this Loading Facility. Aurizon will review this loading time in accordance with the relevant Access Agreement. A variation from the loading time will not result in the Train Service being considered not to be a Reference Train Service until after the loading time is reviewed in accordance with the relevant Access Agreement.

²⁸ This is an estimate of loading time for this Loading Facility. Aurizon will review this loading time in accordance with the relevant Access Agreement. A variation from the loading time will not result in the Train Service being considered not to be a Reference Train Service until after the loading time is reviewed in accordance with the relevant Access Agreement.

²⁹ Diagrams showing the location of the Nominated Unloading Facilities for a nominated Reference Train Service are included in the Preliminary Information for the relevant Coal System.

Reference Tariff input	2017/18 [^] (\$)	2018/19 [^] (\$)	2019/20 [^] (\$)	2020/21 (\$)	2021/22 (\$)	2022/23 (\$)
AT ₁	1.43	1.45	1.48	1.51	1.54	1.57
AT ₂	13,436.76	14,081.21	14,414.93	14,756.57	15,106.30	15,464.32
AT ₃	1.38	1.20	1.36	1.35	1.34 <u>1.24</u>	1.33 <u>1.27</u>
AT ₄	3.44	1.13	1.98	1.95	1.84 <u>1.91</u>	1.70 <u>1.67</u>
QCA Levy	0.03961	0.00907	0.00998	0.00 [~]	0.00979 <u>0.00327</u>	0.00993
IE Fee	N/A	N/A	N/A	0.01812	<u>0.01485</u>	

[^] 2017/18, 2018/19, ~~and 2019/20~~ and 2021/22 Reference Tariffs include the impact of 2015/16, 2016/17, ~~and 2017/18~~ and 2019/20 Revenue Adjustment Amounts respectively. 2019/20 Reference Tariffs also include the impact of the 2018/19 Revenue Adjustment Amounts.

[~] On 20 August 2020, the QCA approved an updated QCA Levy of \$nil to apply from 1 September 2020 to 30 June 2021. For clarity, the annualised QCA Levy for 2020/21 is \$0.00091/nt.

- (b) The Nominal Train Payload for:
- (i) a Train Service to which the Reference Tariff in this **clause 11** applies; or
 - (ii) a Cross System Train Service where the Destination System is the Goonyella to Abbot Point System,
- is a nominal nt of 6,800 tonnes.

11.3 Gtk Forecast and Allowable Revenues

Year	Gtk Forecast (,000 gtk)	Allowable Revenue – AT ₂₋₄ (\$000)
2017/18 ¹	9,937,885	132,282
2018/19 ¹	8,701,241	94,839
2019/20 ¹	9,579,993	123,398
2020/21	9,579,993	124,690
2021/22 ¹	9,579,993 <u>9,467,598</u>	123,926 <u>124,923</u>
2022/23	9,579,993	123,769 <u>122,800</u>

(1) 2017/18, 2018/19, ~~and 2019/20~~ and 2021/22 Allowable Revenues include the impact of 2015/16, 2016/17, ~~and 2017/18~~ and 2019/20 Revenue Adjustment Amounts respectively. 2019/20 Allowable Revenues also include the impact of the 2018/19 Revenue Adjustment Amounts.

12 Transitional provisions – Monthly System Forecasts for 2001 Undertaking Access Agreements

(a) This **clause 12** sets out Monthly System Forecasts for the Blackwater System and Newlands System³⁰ that are to be used as the ‘System Forecasts’ of gtk for the purposes of:

- (i) Access Agreements; and
- (ii) New Access Agreements where the relevant Old Access Agreement was,

executed or renewed during the term of the 2001 Undertaking including in relation to the calculation of “VTP” and “IATP” for Take or Pay charges.

(b) For clarity:

- (i) the Monthly System Forecasts for a Coal System are based on the Gtk Forecast for the System Reference Tariff for that Coal System. Changes to the Gtk Forecast for a System Reference Tariff will affect the Monthly System Forecast for that Coal System; and
- (ii) any process, obligation or right to vary a Gtk Forecast for a System Reference Tariff for a Coal System under this Undertaking must also include any consequential variation to the Monthly System Forecast for that Coal System under this **clause 12**.

Blackwater System

Month	System Gtk (,000 gtk)	Month	System Gtk (,000 gtk)	Month	System Gtk (,000 gtk)
Jul-17	3,280,964	Jul-19	3,170,593	Jul-21	2,860,7413, 188,230
Aug-17	3,280,964	Aug-19	3,170,593	Aug-21	3,088,5703, 442,140
Sep-17	3,172,657	Sep-19	3,065,930	Sep-21	2,900,9343, 233,023
Oct-17	3,280,964	Oct-19	3,170,593	Oct-21	2,847,4503, 173,417
Nov-17	3,172,657	Nov-19	3,065,930	Nov-21	2,949,7263, 287,402

³⁰ **Clause 12** does not apply in relation to the Goonyella System and the Moura System as there are no longer any Access Agreements, or New Access Agreements where the relevant Old Access Agreement was, executed or renewed during the term of the 2001 Undertaking.

Month	System Gtk (,000 gtk)	Month	System Gtk (,000 gtk)	Month	System Gtk (,000 gtk)
Dec-17	3,280,964	Dec-19	3,170,593	Dec-21	3,073,449 , 425,288
Jan-18	3,280,964	Jan-20	3,170,593	Jan-22	2,936,261 , 272,395
Feb-18	3,064,351	Feb-20	2,961,267	Feb-22	2,481,331 , 765,386
Mar-18	3,280,964	Mar-20	3,170,593	Mar-22	2,807,239 , 428,604
Apr-18	3,172,657	Apr-20	3,065,930	Apr-22	2,695,924 , 904,546
May-18	3,280,964	May-20	3,170,593	May-22	3,138,719 , 498,029
Jun-18	3,172,657	Jun-20	3,065,930	Jun-22	3,102,680 , 457,864
Jul-18	3,045,527	Jul-20	3,044,659	Jul-22	3,316,522
Aug-18	3,045,527	Aug-20	3,287,135	Aug-22	3,580,649
Sep-18	2,944,993	Sep-20	3,087,436	Sep-22	3,363,118
Oct-18	3,045,527	Oct-20	3,030,513	Oct-22	3,301,113
Nov-18	2,944,993	Nov-20	3,139,365	Nov-22	3,419,685
Dec-18	3,045,527	Dec-20	3,271,042	Dec-22	3,563,120
Jan-19	3,045,527	Jan-21	3,125,034	Jan-23	3,404,074
Feb-19	2,844,458	Feb-21	2,640,856	Feb-23	2,876,663
Mar-19	3,045,527	Mar-21	2,987,717	Mar-23	3,254,496
Apr-19	2,944,993	Apr-21	2,869,246	Apr-23	3,125,447
May-19	3,045,527	May-21	3,340,508	May-23	3,638,788
Jun-19	2,944,993	Jun-21	3,302,152	Jun-23	3,597,007

Newlands System

Month	System Gtk (,000 gtk)	Month	System Gtk (,000 gtk)
Jul-17	183,699	Jul-19	227,951
Aug-17	183,699	Aug-19	227,951

Month	System Gtk (,000 gtk)	Month	System Gtk (,000 gtk)
Sep-17	177,772	Sep-19	220,597
Oct-17	183,699	Oct-19	227,951
Nov-17	177,772	Nov-19	220,597
Dec-17	183,699	Dec-19	227,951
Jan-18	183,699	Jan-20	227,951
Feb-18	171,847	Feb-20	213,244
Mar-18	183,699	Mar-20	227,951
Apr-18	177,772	Apr-20	220,597
May-18	183,699	May-20	227,951
Jun-18	177,772	Jun-20	220,597
Jul-18	218,747	Jul-20	250,277
Aug-18	218,747	Aug-20	222,825
Sep-18	211,691	Sep-20	230,064
Oct-18	218,747	Oct-20	242,702
Nov-18	211,691	Nov-20	238,076
Dec-18	218,747	Dec-20	217,497
Jan-19	218,747	Jan-21	225,273
Feb-19	204,634	Feb-21	189,546
Mar-19	218,747	Mar-21	227,692
Apr-19	211,691	Apr-21	202,219
May-19	218,747	May-21	223,585
Jun-19	211,691	Jun-21	221,527

Schedule G

Network Management Principles

1 Train Service Entitlements

1.1 Train Service Entitlements:

- (a) for the same types of traffics, will be defined using consistent terminology;³¹ and
- (b) will be expressed in terms that can be interpreted for the development of a Strategic Train Plan (**STP**), a Master Train Plan (**MTP**) or a Capability Train Plan, an Intermediate Train Plan (**ITP**), where necessary, and a Daily Train Plan (**DTP**).

2 Strategic Train Plan principles

- (a) The purpose of the STP for each Coal System is to demonstrate that Aurizon Network has sufficient capacity to deliver existing Train Services Entitlements in:
 - (i) the relevant Coal System; and
 - (ii) the Customer Specific Branch Lines in each Coal System.
- (b) The STP must be developed for and be considered as part of the most recent Capacity Assessment that Aurizon Network has undertaken.
- (c) Aurizon Network will make the STP available to the QCA at the same time it makes the outcomes of the Capacity Assessment available to the QCA and to each Access Holder (or its Customer) and each Access Seeker that requests the relevant STP.
- (d) An STP must provide:
 - (i) an estimate of the Existing Capacity that is anticipated by Aurizon Network:
 - (A) to be necessary to meet its obligations in relation to Train Service Entitlements for a subsequent period of at least one year (but not more than two years) commencing on 1 July; and

³¹ For example, Timetabled Traffics may be defined in terms of a path between certain locations, on particular days, and at particular times. Cyclic Traffics may be defined in terms of a number of train paths per specified period of time.

- (B) in each individual Coal System STP and in aggregate for all Coal System STPs on a Monthly and Yearly basis and in million tonnes per annum, indicating on a system, mainline and branch line basis:
 - (1) for information purposes only, statement of Capacity on a Train Service Entitlement basis, assuming the relevant Nominal Train Payload outlined in **Schedule F** Error! Reference source not found.;
 - (2) the number of Train Service Entitlements that can be provided;
 - (3) the number of Train Service Entitlements that cannot be provided; and
 - (4) available Capacity by Train Paths;
 - (ii) validation of total contracted Train Service Entitlements on a System by System basis;
 - (iii) identification of Operational Constraints (including a quantification of, and any qualifications applicable to, such constraints); and
 - (iv) if different measures of Capacity are agreed, an estimate of the Existing Capacity that is anticipated by Aurizon Network using those measures.
- (e) Aurizon Network must prepare:
- (i) an STP in relation to all Train Service Entitlements in all Coal Systems in aggregate;
 - (ii) a separate STP for each Coal System; and
 - (iii) if requested by the QCA (acting reasonably), a separate STP for groups of Coal Systems or a combination of individual and groups of Coal Systems.
- (f) In preparing an STP, Aurizon Network will consider:
- (i) only the Train Paths that are System Paths;
 - (ii) the known and reasonably anticipated:
 - (A) track maintenance requirements; and
 - (B) impacts of the construction of Expansions, for the period of the STP;
 - (iii) the relevant System Operating Parameters; and
 - (iv) any other factors that may materially impact on the Existing Capacity necessary for Aurizon Network to meet its

obligations in relation to Train Service Entitlements for the period of the STP.

- (g) The STP must specify the material assumptions that Aurizon Network has made during its preparation.
- (h) This **clause 2** of **Schedule G** only has effect, and Aurizon Network's obligations under this **clause 2** of **Schedule G** only apply, up to the date that the IE Initial Capacity Assessment Report is published by Aurizon Network on the Website.

3 Master Train Plan principles

3.1 Purpose and form of the MTP

- (a) The purpose of the MTP is to demonstrate how Aurizon Network plans to deliver Train Service Entitlements in each Coal System, having regard to Planned Possessions, Existing Capacity, the System Operating Parameters and other relevant characteristics of each Coal System.
- (b) The MTP must be published in a tabular timetable form that is readily convertible to an ITP and DTP (with additional time/distance (location) formats if deemed necessary by Aurizon Network) and must specify the capability of Aurizon Network to deliver Train Service Entitlements in each Coal System for a period of at least one (1) Month up to three (3) Months given other activities on the relevant Rail Infrastructure.
- (c) In preparing the MTP, Aurizon Network must consider:
 - (i) any Planned Possessions;
 - (ii) the construction of any Expansions that may impact on the Existing Capacity;
 - (iii) the System Operating Parameters for each Coal System; and
 - (iv) any other factors that may materially impact on the Existing Capacity necessary for Aurizon Network to meet its obligations in relation to Train Service Entitlements.
- (d) Subject to **clause 3.1(f)(ii)** of this **Schedule G**, the MTP will separately identify where applicable:
 - (i) for Cyclic Traffics:
 - (A) the System Paths allocated to Cyclic Traffics; and
 - (B) the Train Paths allocated to non-coal traffic;
 - (ii) for Timetabled Traffics, the particular Train Paths allocated in accordance with the Train Service Entitlements;
 - (iii) each Access Holder's Train Service Entitlements for each Coal System;

- (iv) contracted Cross System Train Service traffic;
 - (v) each Access Holder's Train Paths;
 - (vi) Cross System Train Service traffic paths;
 - (vii) time allocated for Planned Possessions; and
 - (viii) any other factors known to or anticipated by Aurizon Network that may materially impact on the Existing Capacity necessary for Aurizon Network to meet its obligations in relation to Train Service Entitlements.
- (e) The MTP must specify the material assumptions that Aurizon Network made during its preparation.
- (f) Aurizon Network must, on a Monthly basis, provide the MTP for each Coal System as a complete and transparent document:
- (i) if requested, to the QCA on an unredacted basis; and
 - (ii) on its Website;
 - (A) in respect of agreements entered into after the Approval Date of the 2016 Undertaking and to the extent permitted by any confidentiality obligations it may have in relation to the information contained in the MTP (and if those obligations permit disclosure if required by the Undertaking then for the avoidance of doubt Aurizon Network is required to disclose the information contained in the MTP), on an unredacted basis; and
 - (B) in respect of agreements entered into prior to the Approval Date of the 2016 Undertaking or if complete disclosure is not permitted by Aurizon Network's confidentiality obligations:
 - (1) Aurizon Network must use all reasonable endeavours to obtain the consent of the relevant Third Party to disclose the information contained in the MTP on an unredacted basis;
 - (2) in respect of the information referred to in **paragraph (A)** or for which consent is obtained under **paragraph (B)(1)**, on an unredacted basis; and
 - (3) in respect of the information that does not satisfy **paragraph (A)** or for which consent is not obtained under **paragraph (B)(1)**:
 - to the extent possible on an unredacted basis but aggregated so as to avoid disclosing the information

that is confidential and unable to be disclosed;

- to the extent not possible, on a redacted basis.

- (g) Aurizon Network must use reasonable endeavours to agree to confidentiality obligations that:
- (i) do not prevent the disclosure of the information contained in the MTP; and
 - (ii) permit disclosure of information required by this Undertaking,
- But:
- (iii) in any event, must not agree to any confidentiality obligations that prevent disclosure of the information contained in the MTP to the QCA,

provided that Aurizon Network will be deemed to have complied with its obligations under this **clause 3.1(g)** of **Schedule G** if it has requested during the negotiation of an Access Agreement that the Access Seeker agrees to confidentiality obligations in accordance with **clause 3.1(g)(i)** and **clause 3.1(g)(ii)**, whether or not the Access Seeker actually agrees to the inclusion of such obligations in the Access Agreement.

- (h) **Clauses 3.1** and **3.2** of this **Schedule G** only have effect, and Aurizon Network's obligations under **clauses 3.1** and **3.2** of this **Schedule G** only apply, up to the date that the IE Initial Capacity Assessment Report is published by Aurizon Network on the Website.

3.2 Modifying the MTP

- (a) Unless otherwise expressly provided in an Access Holder's Access Agreement or a Train Operations Deed (as applicable), Aurizon Network may make modifications to the MTP on a case-by-case basis only where:
- (i) an Access Holder notifies Aurizon Network that it wishes to make a long-term Train Service Change, provided:
 - (A) that change:
 - (1) is within the scope of its Train Service Entitlement; and
 - (2) does not result in any other Access Holder's scheduled Train Service/s not being met, or a Planned Possession not being met; and
 - (B) the Access Holder has given Aurizon Network reasonable prior notice of that change having regard to the necessary process to be complied

with, and factors to be considered, by Aurizon Network;

- (ii) a Planned Possession is cancelled;
- (iii) a new, varied or additional Train Service Entitlement has been created, through the signing of an Access Agreement or the negotiation of a variation to an Access Agreement (including where that new or amended Access Agreement arises as a result of a Transfer), provided that the new or varied Train Service Entitlement does not result in any other Access Holder's Train Service/s or a Planned Possession, set out in the MTP, not being met;
- (iv) an Access Holder's Access Agreement allows Aurizon Network to alter the Access Holder's Train Service Entitlement – for example, by resuming Access Rights through a capacity resumption process; or
- (v) after consulting with any Access Holders (or their Train Operators, if applicable) whose Train Service/s or Train Service Entitlements are affected by the proposed modification to the MTP, and/or with Infrastructure Service Providers if the proposed modification affects a Planned Possession, where:
 - (A) Aurizon Network notifies all affected Access Holders that it wishes to make a long-term Train Service Change, provided that change:
 - (1) is within the scope of the relevant Access Holders' Train Service Entitlement/s; and
 - (2) is intended to accommodate:
 - the creation of a new or varied Train Service Entitlement, through the signing of an Access Agreement or the negotiation of a variation to an Access Agreement (including where that new or amended Access Agreement arises as a result of a Transfer), where that new or varied Train Service Entitlement cannot otherwise be reasonably accommodated on the MTP;
 - the creation of new Planned Possessions or the modification of existing Planned Possessions; or

- any other Operational Constraint affecting the MTP; and
- (3) where it results in any existing Access Holder's Train Service Entitlement not being met, is only made with the agreement of that existing Access Holder (such agreement not to be unreasonably withheld); or
- (B) Aurizon Network notifies all affected Access Holders, within the time period specified in the relevant System Rules, of a long-term Train Service Change for the purpose of carrying out Major Periodic Maintenance provided that, where that change is not within the scope of an Access Holder's Train Service Entitlement, Aurizon Network has used reasonable endeavours to mitigate the impact on that Access Holder. Any limitations (if any) on Aurizon Network's ability to exercise this right will be specified in individual Access Agreements.
- (b) Aurizon Network may make modifications to the MTP where Aurizon Network and all affected Access Holders, agree in writing. Aurizon Network will invite all Access Holders (and their Train Operators, if applicable) whose Train Service Entitlements are affected by the proposed modification to the MTP to consider the modification in an appropriate forum (which may include a face to face meeting, a telephone conference or any other forum that provides the affected Access Holders with a reasonable opportunity to participate). Aurizon Network must use reasonable endeavours to provide to each affected Access Holder a copy of the proposed changes five (5) Business Days prior to the scheduled consideration of the modification in the forum.
- (c) Aurizon Network must consult with any Infrastructure Service Providers, and any Railway Manager for Private Infrastructure that is directly connected to the Rail Infrastructure, who would reasonably be determined to be affected by any modification to the MTP that is proposed to be agreed under **clause 3.2(a)(v)** or **3.2(b)** and must take into account comments it receives in preparing the MTP.
- (d) Aurizon Network must notify any person who is a Railway Manager for Private Infrastructure that is directly connected to the Rail Infrastructure who (in that capacity as a Railway Manager) would reasonably be determined to be affected by any modification to the MTP that is made under this **clause 3.2** within five (5) Business Days of becoming aware that that person may be affected by a modification to the MTP.

- (e) Notwithstanding:
 - (i) any aspect of this **clause 3.2**, Aurizon Network must not make unilateral amendments to the MTP if there is any possibility that those amendments will materially disadvantage any Access Holder (or its Customer); and
 - (ii) any other provision of this **Schedule G**, the Undertaking or an Access Agreement, any affected Access Holder (or its Customer) may refer a change or amendment to the MTP to the QCA for determination in accordance with **clause 11.1.5**.

3A Capability Train Plan principles

- (a) The purpose of the Capability Train Plan for each Coal System is to demonstrate that Aurizon Network has sufficient capability to deliver existing Train Services Entitlements in each Coal System, having regard to Possessions referred to in **clause 3A(c)** of this **Schedule G**, Existing Capacity, the System Operating Parameters (including any amendments referenced in the most recent Annual Capacity Assessment) and the relevant characteristics of each Coal System.
- (b) The Capability Train Plan must be developed:
 - (i) within 45 days after the IE Initial Capacity Assessment Report is published by Aurizon Network on the Website; and
 - (ii) thereafter within 45 days after Aurizon Network has received the most recent Annual Capacity Assessment for the Capacity Assessment Period to which that Annual Capacity Assessment relates,and Aurizon Network will, promptly after developing the Capability Train Plan, make that Capability Train Plan available to the QCA and publish that Capability Train Plan on its Website.
- (c) Aurizon Network must, at least 60 days prior to the commencement of the Capacity Assessment Period relating to an Annual Capacity Assessment, publish on its Website for a Year details of all Possessions that are expected, at the time of publication, to be required during that Capacity Assessment Period in order to conduct substantial Asset Replacement and Renewal work (**Critical Asset Activity Calendar**).
- (d) A Capability Train Plan must specify the capability of Aurizon Network to deliver Train Service Entitlements in each Coal System for each month of the relevant Capacity Assessment Period by providing a timetable that specifies the Train Paths available after taking into account:
 - (i) Possessions specified in the Critical Asset Activity Calendar;
 - (ii) the construction of any Expansions that may impact on the Existing Capacity;

- (iii) the System Operating Parameters for each Coal System; and
 - (iv) any other factors that may materially impact on the Existing Capacity necessary for Aurizon Network to meet its obligations in relation to Train Service Entitlements.
- (e) The Capability Train Plan must specify the material assumptions that Aurizon Network has made during its preparation.
- (f) Aurizon Network must use reasonable endeavours to agree to confidentiality obligations that:
- (i) do not prevent the disclosure of the information contained in the Capability Train Plan; and
 - (ii) permit disclosure of information required by this Undertaking, but in any event, must not agree to any confidentiality obligations that prevent disclosure of the information contained in the Capability Train Plan to the QCA, provided that Aurizon Network will be deemed to have complied with its obligations under this **clause 3A(f)** of **Schedule G** if it has requested during the negotiation of an Access Agreement that the Access Seeker agrees to confidentiality obligations in accordance with this **clause 3A(f)(i)** and **clause 3A(f)(ii)**, whether or not the Access Seeker actually agrees to the inclusion of such obligations in the Access Agreement.
- (g) **Clause 3A** of this **Schedule G** only has effect, and Aurizon Network's obligations under this **clause 3A** of this **Schedule G** only apply, after the date that the IE Initial Capacity Assessment Report is published by Aurizon Network on the Website.

4 Intermediate Train Plan principles

- (a) An ITP is an intermediate scheduling step in progressing from the MTP when applicable to the DTP. Aurizon Network will consider Planned Possessions, the Train Paths and the System Paths detailed in the MTP when applicable, Train Service Entitlements, Short Term Transfers and Train Orders when developing an ITP for the Relevant Period.
- (b) The scheduling horizon of an ITP will be consistent with the period specified in the relevant System Rules for an ITP.
- (c) Train Orders for an ITP must, unless otherwise advised by Aurizon Network, be submitted to Aurizon Network:
 - (i) in the manner and timeframe specified within the relevant System Rules; or
 - (ii) if there are no relevant System Rules, before 1200 hours on the Wednesday immediately prior to the period for which an ITP is to be prepared.

- (d) Aurizon Network will plan Cyclic Traffics in the ITP in accordance with the relevant System Rules. If the process of planning Cyclic Traffics in the ITP involves the allocation of a Contested Train Path among Access Holders for Cyclic Traffic, Aurizon Network:
 - (i) may require a meeting of all affected Access Holders; and
 - (ii) will use the decision making process in **clause 8** to allocate the Contested Train Path.
- (e) Subject to **clause 4(g)(ii)** of this **Schedule G**, the ITP must identify all allocated Train Paths and all Train Paths allocated to known Possessions. Aurizon Network must also provide the following information to Access Holders, to the extent actually known by Aurizon Network, to enable Access Holders to make an informed assessment of the availability of System Paths:
 - (i) activities affecting the Rail Infrastructure that may:
 - (A) affect the availability of the Rail Infrastructure for the operation of Train Services; and
 - (B) adversely affect the operation of Train Services on the Rail Infrastructure; and
 - (ii) the availability of mine load out and port unloading facilities.
- (f) Once it is finalised but in any event by 1600 hours on the Thursday immediately prior to the commencement of the period for the next ITP (unless otherwise stated in the System Rules), Aurizon Network must provide the ITP as a complete and transparent document to:
 - (i) all Access Holders and
 - (ii) each Customer,
 on the following basis:
 - (A) in respect of agreements entered into after the Approval Date of the 2016 Undertaking and to the extent permitted by any confidentiality obligations it may have in relation to the information contained in the ITP (and if those obligations permit disclosure if required by the Undertaking, then, for the avoidance of doubt Aurizon Network is required to disclose the information contained in the ITP), on an unredacted basis; and
 - (B) in respect of agreements entered into prior to the Approval Date of the 2016 Undertaking or if complete disclosure is not permitted by Aurizon Network's confidentiality obligations:
 - (1) Aurizon Network must use all reasonable endeavours to obtain the consent of the relevant Third Party to disclose the

- information contained in the ITP on an unredacted basis;
- (2) in respect of the information for which consent is obtained under **paragraph (f)(B)(1)**, on an unredacted basis; and
 - (3) in respect of the information for which consent is not obtained under **paragraph (f)(B)(1)**:
 - to the extent possible on an unredacted basis but aggregated so as to avoid disclosing the information that is confidential and unable to be disclosed;
 - to the extent not possible, on a redacted basis.
- (g) Aurizon Network must use reasonable endeavours to agree to confidentiality obligations that:
- (i) do not prevent the disclosure of the information contained in the ITP; and
- permit disclosure of information required by the Undertaking, but
- (ii) in any event, must not agree to any confidentiality obligations that prevent disclosure to the QCA,
- provided that Aurizon Network will be deemed to have complied with its obligations under this **clause 4(g)** of **Schedule G** if it has requested during the negotiation of an Access Agreement that the Access Seeker agrees to confidentiality obligations in accordance with **clause 4(g)(i)** and **clause 4(g)(ii)** whether or not the Access Seeker actually agrees to the inclusion of such obligations in the Access Agreement.
- (h) Aurizon Network will notify relevant Infrastructure Service Providers and the operator of any relevant unloading facilities of the ITP in accordance with any process in the relevant System Rules for such notification.

5 Daily Train Plan principles

5.1 Purpose and form of a DTP

A DTP indicates all scheduled Train Services and Planned Possessions, Urgent Possessions and Emergency Possessions (to the extent known) for a particular day, in a form that indicates the time/distance (location) relationship of all activities on that part of the Rail Infrastructure to which the DTP relates.

5.2 Scheduling and notification of a DTP

Aurizon Network:

- (a) will schedule a DTP at least 24 hours (or such other time required under the relevant System Rules) prior to the day (commencing at 0000 hours and ending at 2359 hours) to which the DTP relates (**Day of Operation**);
- (b) will provide all Access Holders and Infrastructure Service Providers with an extract of the DTP which is relevant to their Train Paths (specifying the Train Services for the relevant Train Operators) by 1400 hours on the day prior to the Day of Operation; and
- (c) will provide each DTP as a complete and transparent document to:
 - (i) all Access Holders and
 - (ii) each Customer,on the following basis:
 - (iii) in respect of agreements entered into after the Approval Date of the 2016 Undertaking and to the extent permitted by any confidentiality obligations it may have in relation to the information contained in the DTP (and if those obligations permit disclosure if required by the Undertaking, then, for the avoidance of doubt, Aurizon Network is required to disclose the information contained in the DTP), on an unredacted basis; and
 - (iv) in respect of agreements entered into prior to the Approval Date of the 2016 Undertaking or, if complete disclosure is not permitted by Aurizon Network's confidentiality obligations:
 - (A) Aurizon Network must use all reasonable endeavours to obtain the consent of the relevant Third Party to disclose the information contained in the DTP on an unredacted basis;
 - (B) in respect of the information for which consent is obtained under **clause 5.2(c)(iv)(A)**, on an unredacted basis; and
 - (C) in respect of the information for which consent is not obtained under **clause 5.2(c)(iv)(A)**:
 - (1) to the extent possible on an unredacted basis but aggregated so as to avoid disclosing the information that is confidential and unable to be disclosed;
 - (2) to the extent not possible, on a redacted basis;

- (d) must use reasonable endeavours to agree to confidentiality obligations that:
 - (i) do not prevent the disclosure of the information contained in the DTP; and
 - (ii) permit disclosure of information required by the Undertaking, but
 - (iii) in any event, must not agree to any confidentiality obligations that prevent disclosure of the information contained in the DTP to the QCA,

provided that Aurizon Network will be deemed to have complied with its obligations under this **clause 5.2(d)** of **Schedule G** if it has requested during the negotiation of an Access Agreement that the Access Seeker agrees to confidentiality obligations in accordance with **clause 5.2(d)(i)** and **clause 5.2(d)(ii)**, whether or not the Access Seeker actually agrees to the inclusion of such obligations in the Access Agreement.

5.3 Application of a DTP to performance targets

The DTP will represent the expected train operation performance target over its period and will be used as base information for performance monitoring.

5.4 Scheduling a DTP in variation to the ITP

- (a) A DTP may be scheduled in variation to the ITP in accordance with the timeframes specified in the System Rules.
- (b) A request or notice by an Access Holder to Aurizon Network in relation to scheduling the DTP in variation to the ITP must be in the form reasonably required by Aurizon Network, and provided in accordance with Aurizon Network's reasonable requirements, from time to time. For clarity, Aurizon Network will notify Access Holders of its requirements:
 - (i) as at the Approval Date, within two (2) Business Days after the Approval Date; and
 - (ii) after the Approval Date, from time to time in advance (provided the notice provides reasonable time for the Access Holder to comply).
- (c) The DTP may be scheduled in variation to the ITP where at least 48 hours (or such other time required under the relevant System Rules) prior to the Day of Operation:
 - (i) an Access Holder notifies Aurizon Network that it wishes to make a short-term Train Service Change at which its Train Services, as scheduled in the ITP, operate, whether or not within the scope of its Train Service Entitlement, provided that change does not result in any other Access Holder's

- scheduled Train Services, or a Planned Possession, not being met;
- (ii) Aurizon Network receives a request from an Access Holder to run an additional Train Service which is within the scope of its Train Service Entitlement or an Ad Hoc Train Service, provided that the additional Train Service or Ad Hoc Train Service, as applicable, would not result in any Access Holder's scheduled Train Services, or a Planned Possession, not being met;
 - (iii) a Planned Possession is cancelled;
 - (iv) Aurizon Network notifies all affected Access Holders that it wishes to make a short-term Train Service Change at which any scheduled Train Service/s operate, provided that:
 - (A) the change is intended to accommodate:
 - (1) the modification of an existing Planned Possession;
 - (2) the creation of an Urgent Possession; or
 - (3) any other Operational Constraint affecting the DTP; and
 - (B) either:
 - (1) the change is within the scope of the relevant Access Holders' Train Service Entitlements; or
 - (2) where the change results in an Access Holder's Train Service Entitlement not being met, that Access Holder has consented to the change (which consent must not to be unreasonably withheld or delayed);
 - (v) Aurizon Network requests a short-term Train Service Change at which any scheduled Train Services operate, whether or not within the scope of the applicable Access Holders' Train Service Entitlements, for the purpose of accommodating an Emergency Possession; or
 - (vi) Aurizon Network and all affected Access Holders agree.
- (d) Aurizon Network may schedule the DTP in variation to the ITP:
- (i) under any of **clauses 5.4(c)(i) to (iii)**, without the need for consultation;
 - (ii) under **clauses 5.4(c)(iv) or (v)**, after consulting with any affected Access Holders; or
 - (iii) under **clause 5.4(c)(vi)**, after:

- (A) inviting relevant affected Access Holders to consider the modification in an appropriate forum (which may include a face to face meeting, a telephone conference or any other forum that provides the affected Access Holders with a reasonable opportunity to participate), that occurs prior to the Day of Operation; and
 - (B) providing those affected Access Holders with a copy of the proposed modification as soon as practicable prior to the forum.
- (e) Where the DTP is scheduled in variation from the ITP under this **clause 5.4**, Aurizon Network will notify any Railway Manager for Private Infrastructure that is directly connected to the Rail Infrastructure and who may be affected by those variations. The notification will be given to the Railway Manager in that person's capacity as a Railway Manager.

5.5 Variations to a DTP after it is scheduled

- (a) Variations to the DTP, either prior to or during the Day of Operation, may occur:
- (i) without consultation with Access Holders, if the variation does not result in:
 - (A) those Access Holders' scheduled Train Services not being provided; or
 - (B) any Possession not being met; and
 - (ii) if **clause 5.5(a)(i)(A)** does not apply, as agreed among Aurizon Network and the affected Access Holders.
- (b) Once the DTP is scheduled, variations to the DTP may only be made where:
- (i) in the case of an Access Holder requesting or notifying Aurizon Network seeking a variation to the DTP, the request or notice is in the form and provided in accordance with Aurizon Network's reasonable requirements from time to time (which requirements Aurizon Network will notify Access Holders in advance); and
 - (ii) any one or more of the following apply:
 - (A) each of the following is satisfied:
 - (1) before the Day of Operation, Aurizon Network receives a request from an Access Holder to run an additional Train Service which is within the scope of its Train Service Entitlement or an Ad Hoc Train Service; and

- (2) the additional Train Service or Ad Hoc Train Service, as applicable, would not result in any existing Access Holder's scheduled Train Services not being met, or a Possession (whether a Planned Possession, Emergency Possession or Urgent Possession) not being met;
 - (B) each of the following is satisfied:
 - (1) before the relevant Train Service commences, an Access Holder notifies Aurizon Network that it wishes to make a change to the times at which its Train Service operates;
 - (2) that change is within the scope of the Access Holder's Train Service Entitlement; and
 - (3) that change does not result in any other Access Holder's scheduled Train Service not being met or a Possession (whether a Planned Possession, Emergency Possession or Urgent Possession) not being met; or
 - (C) before the relevant Train Service commences, Aurizon Network notifies the Access Holder that an Emergency Possession is required.
- (c) Other than as detailed in this **clause 5.5**, once the DTP is scheduled, any changes to the plan will be reflected as deviations from the DTP, not variations to the scheduled DTP. Deviations to the DTP may occur on the Day of Operation under **clause 7** including in the event of Out-Of-Course Running. Those deviations will occur according to the Network Control principles in **clause 7**.
- (d) For clarity, if:
 - (i) a variation is requested or notified to Aurizon Network under **clause 5.5(b)(ii)(A) or (B)** and Aurizon Network (acting reasonably) refuses to make that variation; and
 - (ii) despite that refusal the relevant Access Holder seeks to operate the Train Service in accordance with that proposed variation,

then any such operation of the Train Service will be treated as a deviation from the DTP caused by the relevant Access Holder.
- (e) Where a variation to the DTP occurs under this **clause 5.5**, Aurizon Network will notify any Railway Manager and Infrastructure Service

Providers for Private Infrastructure that is directly connected to the Rail Infrastructure who may be affected by those variations.

6 Effect of cancellations on other Access Agreement obligations

The cancellation of a Train Service or Train Services in accordance with the Network Management Principles does not necessarily excuse either Aurizon Network or an Access Holder from other Access Agreement obligations relating to the conduct in question.

7 Network Control principles

7.1 Objective of Network Control

A fundamental objective of Network Control is to facilitate the safe running of Train Services, and the commencement and completion of Planned Possessions, Emergency Possessions and Urgent Possessions, as scheduled in the DTP.

7.2 Effect of deviations from DTP on Day of Operation

The ability of Aurizon Network or an Access Holder to deviate from the DTP on the Day of Operation, as specified below, does not necessarily excuse either Aurizon Network or the Access Holder from any other Access Agreement obligations relating to that deviation.

7.3 General principles

- (a) The following general principles apply to Train Operators, Network Controllers and Aurizon Network (as applicable):
 - (i) the Train Operators and Network Controllers will ensure that operational safety is maintained through compliance with the Safeworking Procedures, the Safety Standards, Rollingstock Interface Standards and applicable IRMPs;
 - (ii) Train Operators will ensure that Above Rail issues, including Train crewing, locomotive and wagon availability and loading and unloading requirements, are appropriately managed to ensure that such issues do not prevent the DTP from being met;
 - (iii) Aurizon Network will manage the Rail Infrastructure based on agreed entry/exit times as specified in the DTP with the objective of managing Trains according to their schedule for on time exit, not contributing to late running and, if a Train is running late, making up time and holding the gain where reasonably possible;
 - (iv) train control and traffic management processes must consider the System Rules and Train Service Entitlements of

Access Holders, with the objective of an equitable outcome maximising the ability of each Coal System to meet contractual entitlements;

- (v) decisions involving reordering the sequence of a train's arrival at an unloader must be referred to the unloading terminal to assist with the determination of priority; and
 - (vi) at all times, the exercise of Network Controller discretion must be transparent and equitable.
- (b) The handling of Out-Of-Course Running is dependent on the particular circumstances of a rail corridor, including the traffic type using the corridor. The management of Out-Of-Course Running will be conducted so as not to unfairly disadvantage one Access Holder over another, and as a result, the identity of an Access Holder will not of itself be a legitimate basis for Network Controllers to alter a scheduled Train Service.

7.4 Application of traffic management decision making matrix

- (a) The traffic management decision making matrix in **clause 9** will be provided to assist Network Controllers in the resolution of disputes in accordance with the general Network Control principles under **clause 7.3**.
- (b) Subject to **clause 7.4(c)**, where the operation of a Train Service differs from the DTP, Network Controllers will apply the traffic management decision making matrix in **clause 9** for the purposes of Network Control.
- (c) Aurizon Network may depart from the traffic management decision making matrix in **clause 9** in the period following a Network Incident, or a Force Majeure Event which materially affects Aurizon Network's ability to achieve the DTP, for any of the following purposes:
 - (i) ensuring Aurizon Network complies with its duties and obligations under any Law relating to safety or health including the Rail Safety Act;
 - (ii) maximising the throughput of Trains on the Rail Infrastructure; and
 - (iii) restoring normal operations on the Rail Infrastructure, provided that Aurizon Network:
 - (iv) only departs from the traffic management decision making matrix in **clause 9** where:
 - (A) it has no other options available to restore the Rail Infrastructure to normal operations; or
 - (B) the departure is required for safety reasons,

and Aurizon Network uses all reasonable endeavours to minimise the length of its departure from the traffic management decision making matrix in **clause 9**, acting reasonably and having due regard to the traffic management decision making matrix in **clause 9**;

- (v) complies with this **clause 7**; and
 - (vi) uses reasonable endeavours to return to normal Network Control procedures for resolving conflicts that arise from Out-Of-Course Running as soon as reasonably practicable after the occurrence of the Network Incident or Force Majeure Event (as applicable).
- (d) Where **clause 7.4(c)** applies, Aurizon Network will keep affected Access Holders reasonably informed of the status of the Network Incident or Force Majeure Event (as applicable) including progress towards returning to normal Network Control procedures for resolving conflicts that arise from Out-Of-Course Running.

7.5 Provision of information to Access Holders

Aurizon Network will provide Access Holders with:

- (a) real time Network Control information that indicates actual running of that Access Holder's Train Services against the relevant DTP;
- (b) upon request and subject to reasonable terms and conditions, access to Network Control diagrams that indicate actual running of that Access Holder's Train Services against the relevant DTP; and
- (c) information about the type of Train Services (for example, non-coal freight, passenger or coal Train Services) operated by other Access Holders on the same network to assist Access Holders to determine whether the Network Controller is applying the principles in this **Schedule G** in a consistent manner between Access Holders.

7.6 Monthly Train Service Entitlement notice

After the end of each Month, Aurizon Network must:

- (a) provide a notice to each Access Holder and its Customer or Train Operator, as applicable, which identifies for each origin to destination pair:
 - (i) the number of Train Paths (or, if appropriate, System Paths) that the Access Holder was entitled to under the Access Holder's Train Service Entitlement;
 - (ii) the number of Train Paths (or, if appropriate, System Paths):
 - (A) planned in the ITP and the DTP; and
 - (B) cancelled in the ITP and the DTP,
- in relation to that Train Service Entitlement;

- (iii) the number of Train Paths (or, if appropriate, System Paths) in respect of which Train Services were operated for the Access Holder under the relevant Train Service Entitlement;
 - (iv) the number of Train Paths (or, if appropriate, System Paths) cancelled in that Month and the reasons for those cancellations;
 - (v) the extent to which the Access Holder's Train Service Entitlement was used, disregarding cancelled Train Paths (or, if appropriate, System Paths); and
 - (vi) the Year-to-date Train Service Entitlement position, both for the Access Holder and for each Coal System,
- for that Month; and
- (b) publish on its Website the aggregated Train Service Entitlement reconciliation reports for each Coal System.

8 Contested Train Path decision making process

8.1 Purpose

The purpose of this **clause 8** is to outline the principles that Aurizon Network will have regard to when allocating a Contested Train Path to an Access Holder for the purpose of developing the ITP (under **clause 4**) with the objective of (in the following order of precedence):

- (a) ensuring Aurizon Network meets its contractual obligations with Access Holders; then
- (b) ensuring Access Holders are not unfairly differentiated between in respect of the use of their Train Service Entitlement; then
- (c) maximising the throughput of Trains on the Rail Infrastructure subject to:
 - (i) Operational Constraints; and
 - (ii) other restrictions or constraints affecting the whole, or partial unavailability of, the Supply Chain.

8.2 TSE Reconciliation Report

- (a) For the purpose of the planning and scheduling of Train Orders³², after the end of each Relevant Period, Aurizon Network will provide a report (**TSE Reconciliation Report**) to each Access Holder and its Customers which identifies as at the end of that Relevant Period, in respect of that Access Holder's Train Service Entitlement under which Train Services were entitled to operate during that Relevant Period:

³² For clarity, the TSE Reconciliation Report and the calculations made for the purposes of that report do not affect or apply in relation to the calculation of Take or Pay.

- (i) the extent to which the Train Service Entitlement:
 - (A) was used in the Relevant Period;
 - (B) has been used in the relevant Access Provision Period to date; and
 - (C) has been used in the relevant Year to date, for each origin to destination pair of the Train Service Entitlement; and
 - (ii) the remaining balance of the Train Service Entitlement for:
 - (A) the relevant Access Provision Period; and
 - (B) the relevant Year,
 for each origin to destination pair of the Train Service Entitlement.
- (b) For the purpose of **clause 8.2(a)(i)**, the extent to which a Train Service Entitlement was or has been used in respect of a particular origin to destination pair will be calculated as the greater of:
- (i) the number of the Train Services operated in accordance with the Train Service Entitlement for that origin to destination pair for the Relevant Period; and
 - (ii) the number of System Paths scheduled for Train Services in accordance with Train Service Entitlement for that origin to destination pair for the Relevant Period.
- (c) The principles used to determine the number of System Paths scheduled or operated for the purpose of **clause 8.2(b)** include the following:
- (i) the point at which a schedule for Train Services is considered final will be:
 - (A) as specified in the System Rules; or
 - (B) if the System Rules do not specify that point or there are no applicable System Rules, System Paths are taken to be scheduled 48 hours prior to the Day of Operation subject to **clause 8.2(c)(i)**; and
 - (ii) the number of System Paths scheduled will be reduced by the number of scheduled System Paths not provided due to Aurizon Network Cause or a Force Majeure Event affecting Aurizon Network in the period to which the schedule applies as per **clause 8.2(c)(i)**.
 - (iii) Where the scheduled time of the Train Path (or, if appropriate, System Path) is varied in accordance with **clause 5**, that variation is not taken to involve the scheduling

of more than one Train Path (or, if appropriate, System Path) unless, for clarity, that variation is a cancellation of the Train Path (or, if appropriate, System Path) in which case (subject to **clause 8.2(c)(ii)**) the Train Service Entitlement is taken to be operated in respect of that cancelled Train Path.

- (iv) To the extent an Access Agreement requires Aurizon Network to provide to an Access Holder a reasonable alternative Train Path (or, if appropriate, System Path) or to determine whether infrastructure has not been made available due to Aurizon Network Cause or a Force Majeure Event affecting Aurizon Network, a Train Path (or, if appropriate, System Path) will be deemed to be a reasonable alternative Train Path (or, if appropriate, System Path) where it is within the same period to which the schedule applies and it is practical for the Access Holder to use it (acting reasonably).
- (d) The remaining balance of a Train Service Entitlement, as amended from time to time, for a particular origin to destination pair for an Access Provision Period under **clause 8.2(a)(ii)(A)** is calculated as:
 - (i) the number of System Paths for that Access Provision Period that Aurizon Network is obliged to make available during that Access Provision Period in accordance with the Train Service Entitlement (including as amended from time to time); less
 - (ii) the Train Service Entitlement used in the Access Provision Period to date (determined in accordance with **clause 8.2(a)(i)(B)**).
- (e) The remaining balance of a Train Service Entitlement, as amended from time to time, for a particular origin to destination pair for the relevant Year under **clause 8.2(a)(ii)(B)** is calculated as:
 - (i) the number of System Paths for that origin to destination pair for that Year that Aurizon Network is obliged to make available during that Year in accordance with the Train Service Entitlement (including as amended from time to time); less
 - (ii) the Train Service Entitlement for a particular origin to destination pair used in the Year to date (determined in accordance with **clause 8.2(a)(i)(C)**).

8.3 Contested Train Path principles

- (a) Aurizon Network will determine which Access Holder is allocated a Train Path that is a Contested Train Path, using the following principles in order of precedence:

- (i) Firstly, the Access Holder whose request for the Contested Train Path is within the scope of its individual Train Service Entitlement for an origin to destination pair (including any Short Term Transfers which have been effected in accordance with **clause 7.4**).
- (ii) If a Contested Train Path is not allocated in accordance with **clause 8.3(a)(i)**, where the relevant Access Holders agree amongst themselves who should be allocated the Contested Train Path, the Contested Train Path will be allocated as agreed by the Access Holders.
- (iii) If there is no agreement between the relevant Access Holders under **clause 8.3(a)(ii)**:
 - (A) an Access Holder submits Train Orders for less than its Train Service Entitlement for a particular origin to destination pair for a Relevant Period (**First Entitlement**); and
 - (B) that Access Holder also submits Train Orders for a different Train Service Entitlement for a particular origin to destination pair for a Relevant Period in excess of its Train Service Entitlement for that origin destination pair (**Second Entitlement**),

then the path will be allocated to the Second Entitlement in the manner requested by the Access Holder, and that allocation will be deemed to be scheduled and operated against the First Entitlement.
- (iv) If there is no allocation of paths under **clause 8.3(a)(iii)**, the Access Holder whose request for the Contested Train Path is within the scope of its relevant Train Service Entitlement adjusted for Aurizon Network Cause or a Force Majeure Event affecting Aurizon Network as follows:
 - (A) the Train Paths finally scheduled, in accordance with **clause 8.2(c)(i)**, for which Train Services did not operate due to Aurizon Network Cause or a Force Majeure Event affecting Aurizon Network Year to date; less
 - (B) the greater of:
 - (1) zero; and
 - (2) the relevant Train Service Entitlement used for Year to date less Train Service Entitlement to date.
- (v) If a Contested Train Path remains unallocated after the application of **clause 8.3(a)(iii)**, the Access Holder who is most behind for the relevant Access Provision Period, by

calculating as a percentage the Train Service Entitlement for the relevant origin to destination pair used in the Access Provision Period to date as per **clause 8.2(a)(i)(B)** plus the remaining balance of the Train Service Entitlement for that origin to destination pair for the Access Provision Period compared against the Train Service Entitlement for that origin to destination pair for that Access Provision Period at the commencement of the Access Provision Period or as amended from time to time.

- (vi) If a Contested Train Path remains unallocated after the application of **clause 8.3(a)(v)**, the Access Holder who is most behind for the relevant Year, by calculating as a percentage the Train Service Entitlement for the relevant origin to destination pair used in the Year to date as per **clause 8.2(a)(i)(C)** plus the remaining balance of the Train Service Entitlement for that origin to destination pair for the Year compared against the Train Service Entitlement for that origin to destination pair for that Year at the commencement of the Year or as amended from time to time.
- (vii) If a Contested Train Path remains unallocated after the application of **clause 8.3(a)(vi)** and a Supply Chain Group has been established to manage or oversee Supply Chain logistics for multiple Access Holders, in accordance with the direction of that body.
- (viii) If a Contested Train Path remains unallocated after the application of **clause 8.3(a)(vii)**, Aurizon Network may unilaterally determine which Train Service is scheduled, and will keep a record of that decision and the reasoning behind that decision. Aurizon Network will seek to ensure that, over time, no Access Holder is favoured over another and, where possible, if one Access Holder is favoured this time, taking into account the Train Service Entitlement held by an Access Holder, next time they are not favoured. In other words, if one Access Holder has an entitlement to ten (10) Train Services per week, and another Access Holder has an entitlement to twenty (20) Train Services per week, then it could not be said that favouritism was shown to the second Access Holder if they received priority over the first Access Holder on two out of three consecutive occasions.
- (ix) Aurizon Network will advise each Access Holder (and its Customers) of the Contested Train Path decision, including details of the contest and the principle that determined the result.

9 Traffic management decision making matrix

For the purposes of the traffic management decision making matrix below the meaning of **On Time**, **Ahead** and **Late** are determined by the scheduling of Train Paths in the DTP. For example, if a Train is travelling in accordance with the DTP path allocated to it, it is running **On Time**.

		Train A – Current Status			
		Train A	Train Running “On Time”	Train Running “Ahead”	Train Running “Late”
Train B – Current Status	Train B	Objective	On Time Exit	On Time Exit	<ol style="list-style-type: none"> 1. Lose no more time 2. Make up time 3. Hold the gain
	Train Running “On Time”	On Time Exit	Scheduled Cross	B Rule 2	B Rule 3
	Train Running “Ahead”	On Time Exit	A Rule 2	A or B Rule 2	B Rule 3
	Train Running “Late”	<ol style="list-style-type: none"> 1. Lose no more time 2. Make up time 3. Hold the gain 	A Rule 1	A Rule 1	A or B Rule 4

- Rule 1:** Train B may be given priority on condition Train A will still meet its “On Time” objective, or as permitted by rules 5, 6, 7 and 8.
- Rule 2:** Both Trains must meet their “On Time” objective.
- Rule 3:** Train A may be given priority on condition Train B will still meet its “On Time” objective, or as permitted by rules 5, 6, 7 and 8.
- Rule 4:** Priority may be given to the Train where performance indicates it will lose least or no more time and even make up time and hold the gain, or as permitted by rules 5, 6, 7 and 8.
- Rule 5:** Passenger and livestock Trains may be given priority over other Trains if the Network Controller reasonably believes that this is consistent with the objectives of the Trains in question, as specified in the Train Service Entitlement/s for those Trains and/or the requirements of a Passenger Priority Obligation.

- Rule 6:** Where a Train is running “Late” due to a Below Rail Delay, it may be given preference over other Trains if the Network Controller reasonably believes that this is consistent with the critical objectives of the Trains in question, and that it will result in less aggregated consequential delays to other Trains than otherwise would be the case.
- Rule 7:** Where a Network Controller has to decide which of two Trains to give priority to, and both of those Trains are operated by the same Access Holder, the Network Controller may ask the Access Holder how it would prefer the Trains to be directed and, provided that taking the Access Holder’s preferred course of action does not adversely affect the Train Services of any other Access Holder, the Network Controller will follow the Access Holder’s request.
- Rule 8:** Where a Network Controller has to decide which of two Trains to give priority to, and those Trains are operated by different Access Holders, one may be given preference over the other if the Network Controller reasonably believes that this is consistent with meeting the coal supply objective(s) detailed in the System Rules.

Schedule H

Explanatory diagrams and flowcharts

The diagrams and flowcharts in this **Schedule H**:

- (a) are intended to assist users of this Undertaking to conceptualise specific processes set out in **Part 1 to Part 12** (inclusive) of this Undertaking; and
- (b) must not be used in substitution for the relevant provisions set out in **Part 1 to Part 12** (inclusive) of this Undertaking.

Negotiation process

[Drafting Note: Diagram that clearly and accurately reflects the **Part 4** processes (and showing relevant linkages to other parts of the Undertaking) to be included.]

Capacity allocation for Mutually Exclusive Access Applications

[Drafting Note: Diagram that clearly and accurately reflects the **Part 4** processes (and showing relevant linkages to other parts of the Undertaking) to be included.]

Short Term Transfer and Long Term Transfer

[Drafting Note: Diagram that clearly and accurately reflects the **Part 7.4** processes (and showing relevant linkages to other parts of the Undertaking) to be included.]

Negotiation process

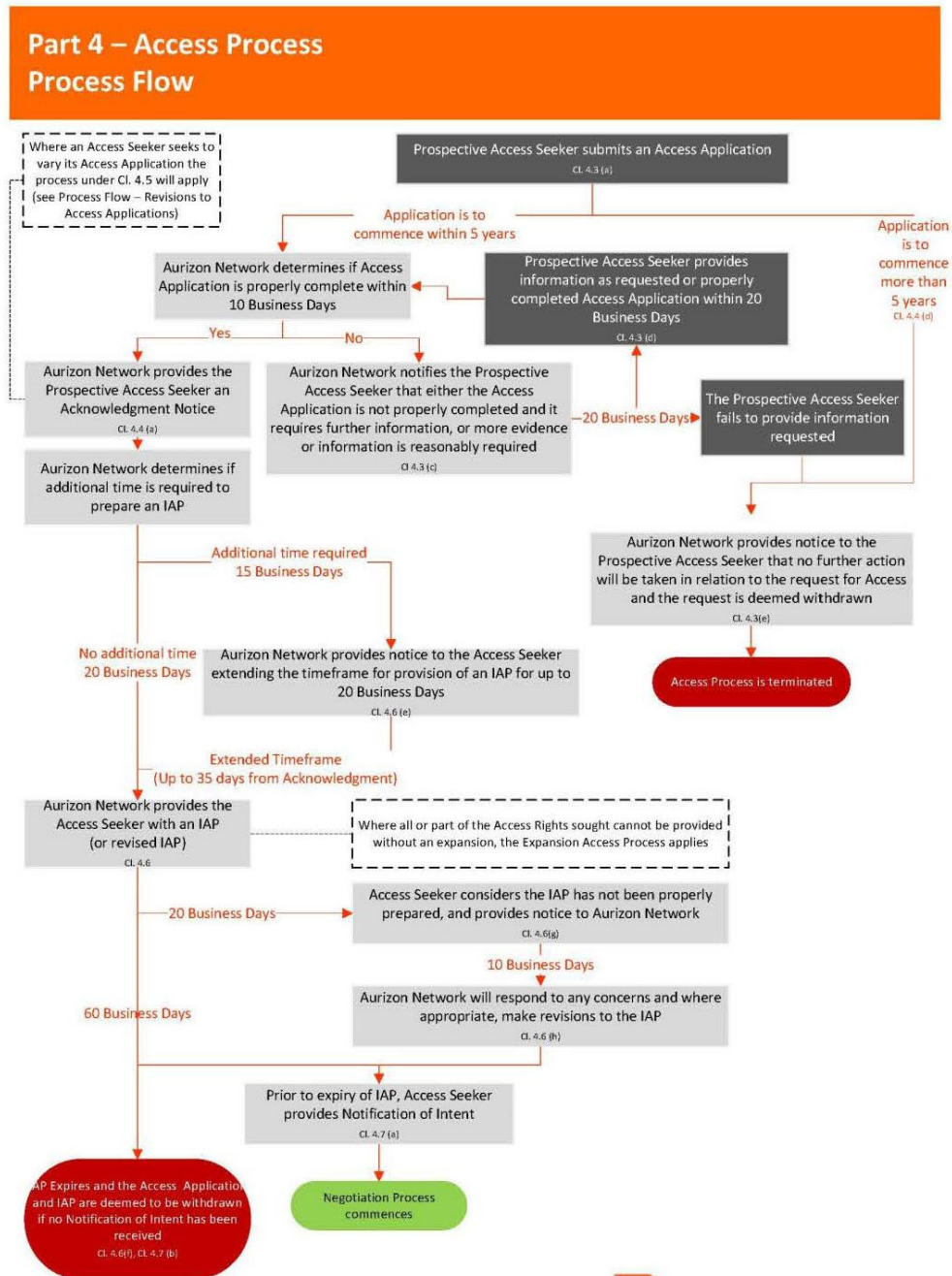

Part 4.8 – Access Applications that require Expansions Process Flow

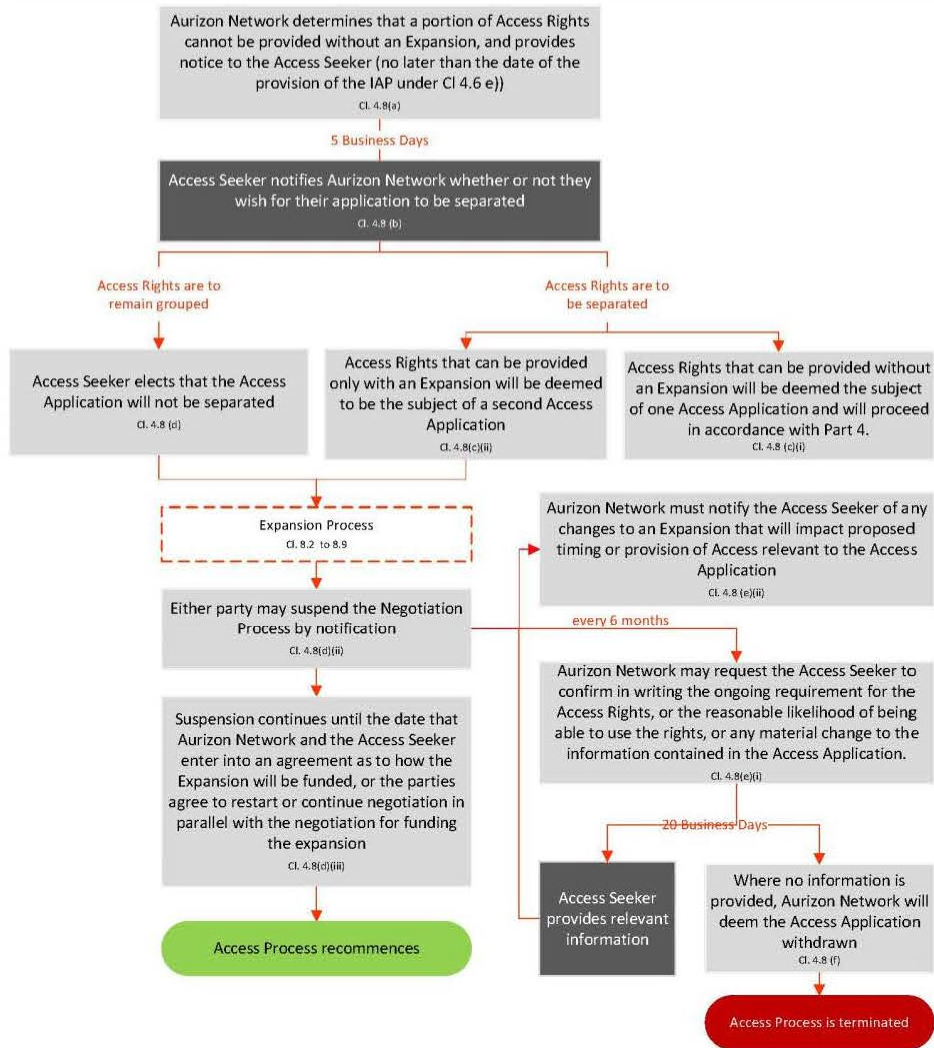

Part 4.5 – Revisions to Access Applications Process Flow

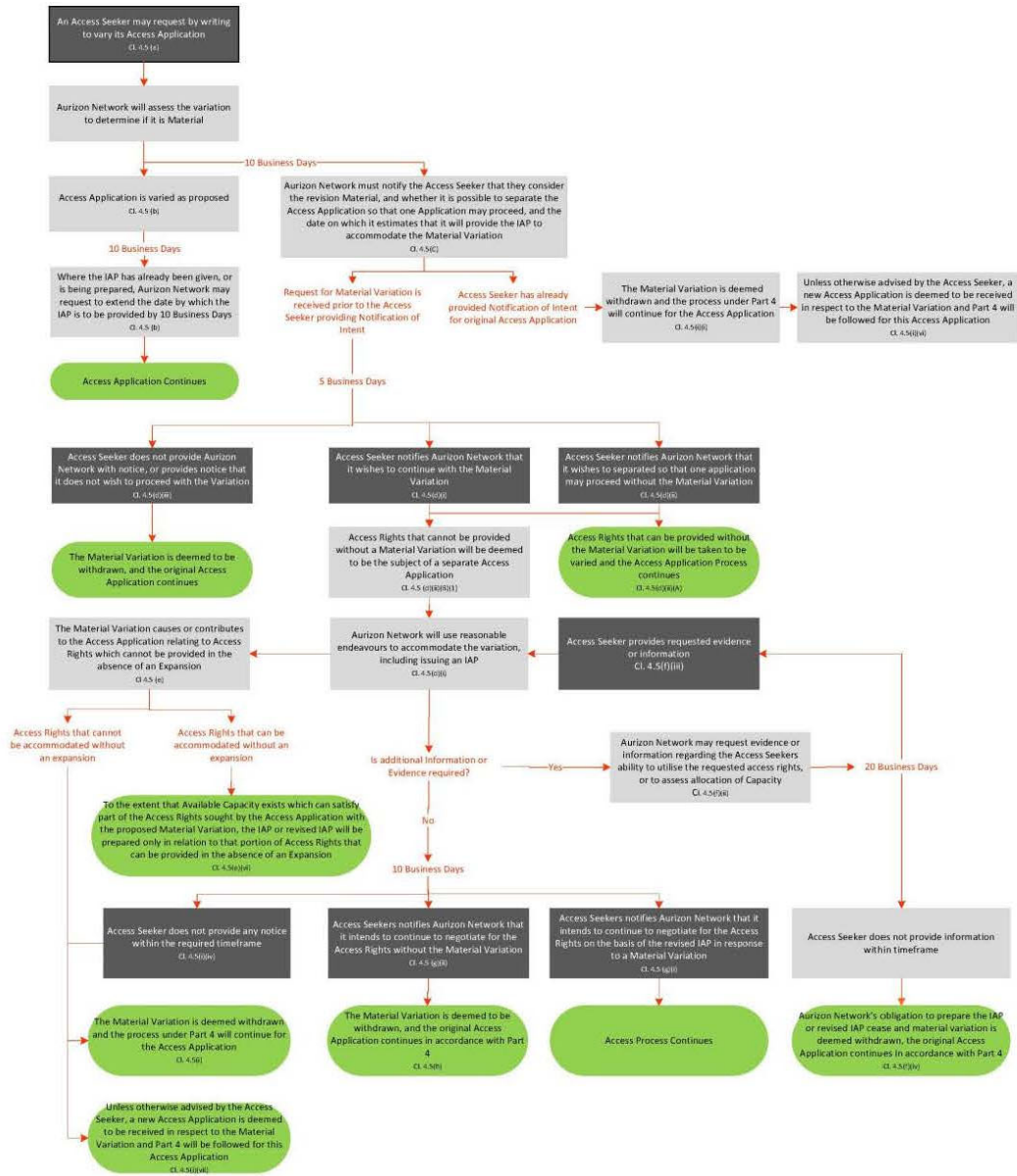

Capacity allocation – no Extension

Part 7.5 - Mutually Exclusive Access Applications
Process Flow

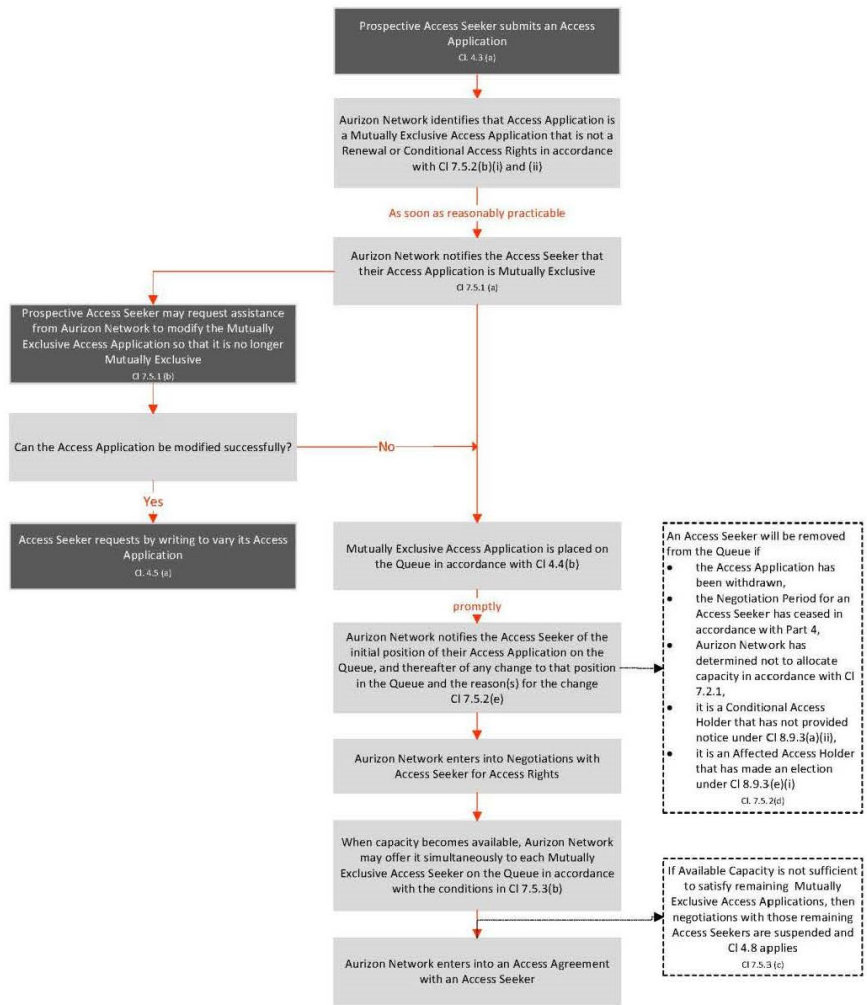

Part 7.4 - Transfer Process (Diagram A)

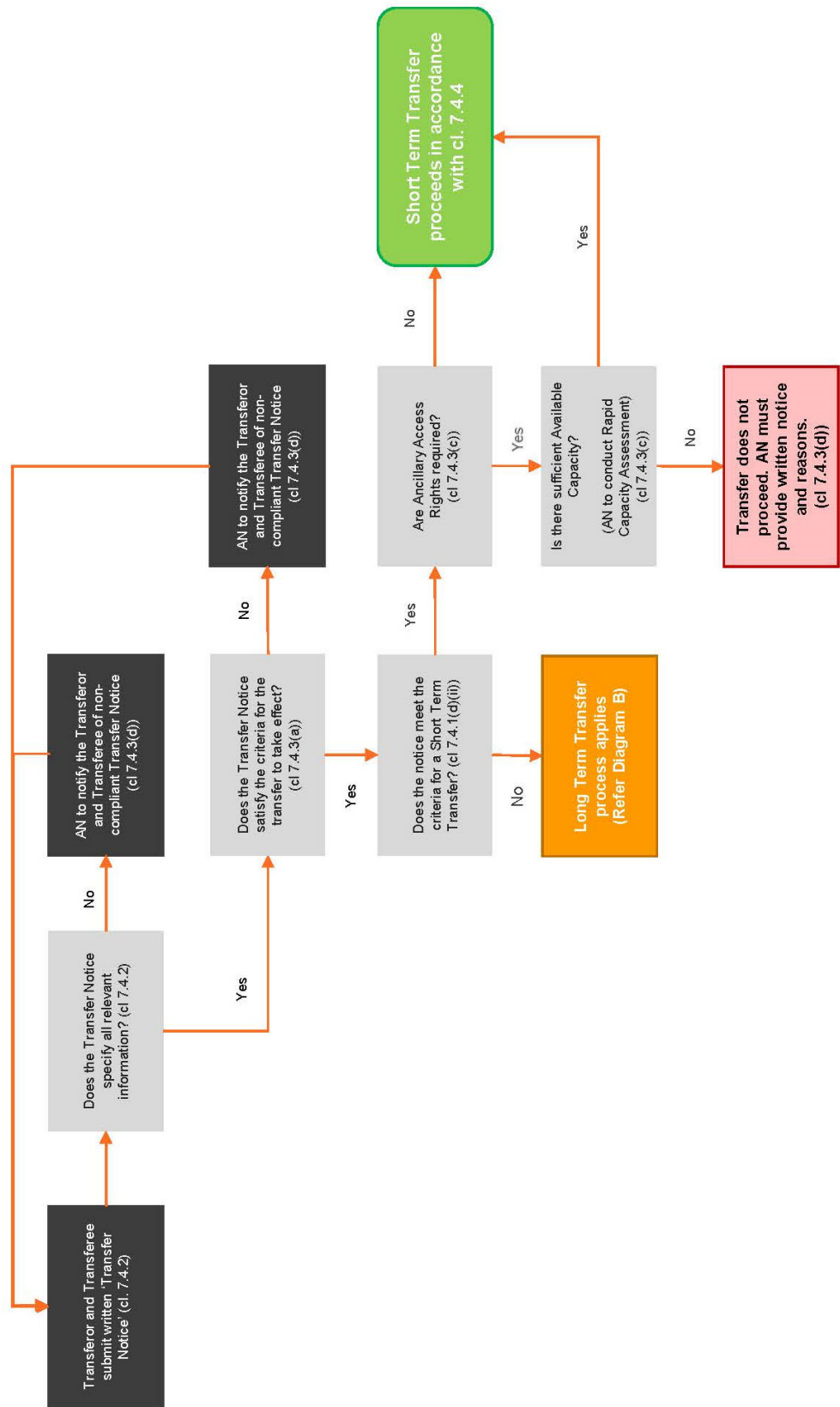

Part 7.4 - Transfer Process (Diagram B - Long Term Transfer)

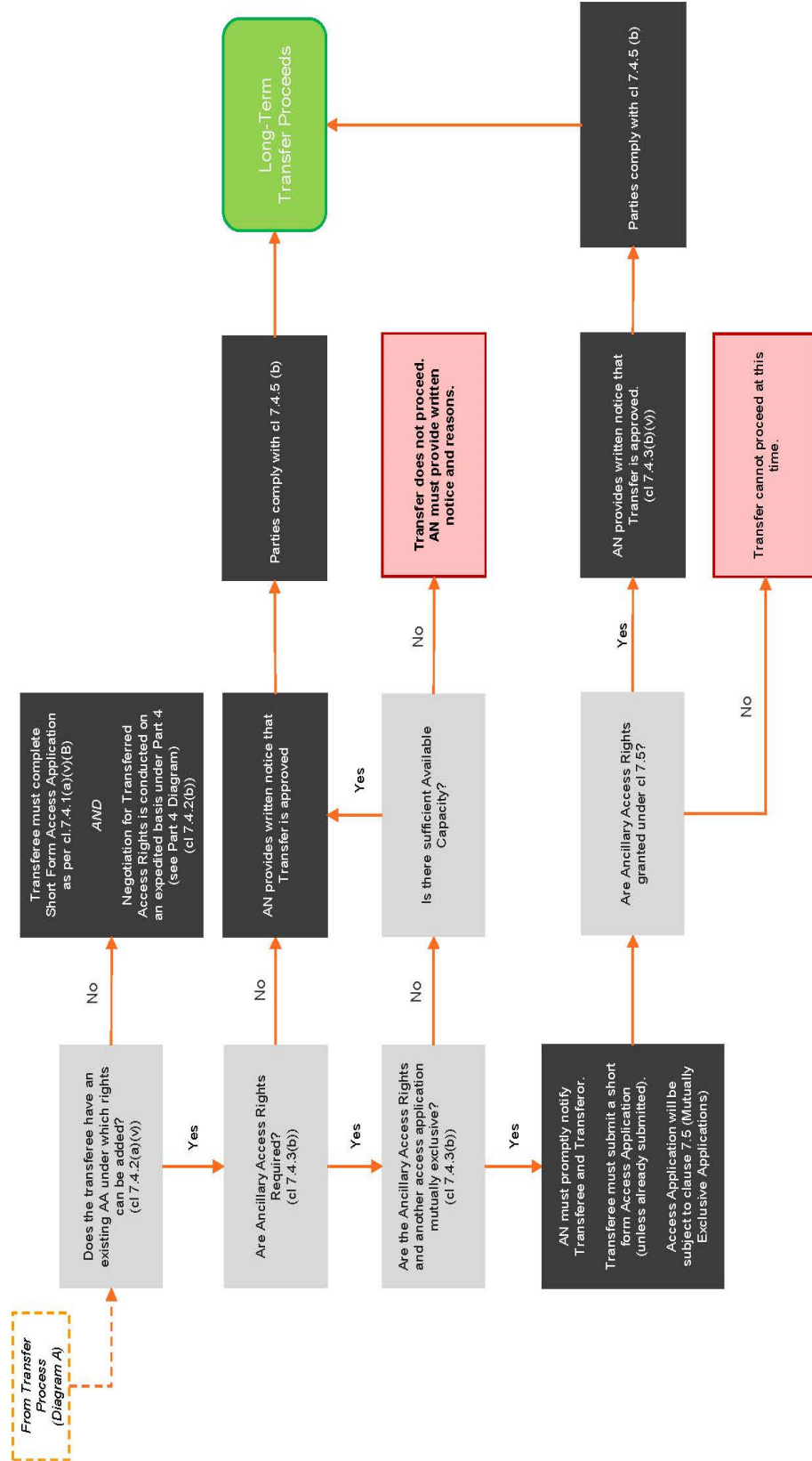

Schedule I

Confidentiality Agreement

[Insert Name of Discloser]

Aurizon Network Pty Ltd

Confidentiality Agreement

Contents

1	Definitions	506 ⁵⁸³
2	Consideration	584
	2.1 Consideration	584
	2.2 No offer or acceptance for Transaction	584
3	Confidentiality	584
4	Exceptions	585
5	Counterparty's obligations	587
6	Aurizon Network obligations	587
7	Breach of agreement	587
8	Termination	588
9	Notices	588
	9.1 Form of Notice	588
	9.2 Method of giving Notices	588
	9.3 Particulars for giving of Notices	589
	9.4 Notice by post	589
	9.5 Notice by fax	589
	9.6 Notice by email	589
	9.7 After hours Notice	589
10	General	590
	10.1 No licence	590
	10.2 Variation	590
	10.3 No assignment	590
	10.4 Costs	590
	10.5 Counterparts	590
	10.6 Effect of execution	590
	10.7 Construction	590
11	Governing law and jurisdiction	591
	Schedule 1	592

Date

Parties

Aurizon Network Pty Ltd ABN 78 132 181 116 of Level 17, 175 Eagle Street, Brisbane, Queensland (**Aurizon Network**)

The person specified in **item 1 of Schedule 1 (Counterparty)**

Background

- A The parties have agreed to enter into this agreement to facilitate the exchange of information between Aurizon Network and the Counterparty.
- B This agreement provides for the disclosure of Confidential Information between the Counterparty and Aurizon Network.
-

Agreed terms

1 Definitions

- (a) In this agreement the following terms have the following meanings:

Business Day	A day which is not a Saturday, Sunday or bank or public holiday in Brisbane.
Purpose	The purpose for which the Confidential Information is to be used set out in item 2 of Schedule 1 .
Transaction	The transaction for which the owner of the Confidential Information agrees to permit the Recipient with access to the Confidential Information, as set out in item 3 of Schedule 1 .
Undertaking	The current access undertaking submitted by Aurizon Network to the Queensland Competition Authority and approved by the Queensland Competition Authority under the <i>Queensland Competition Authority Act 1997</i> (Qld) as at the date of this agreement and as amended or replaced from time to time.

- (b) Unless the context otherwise requires, terms defined in the Undertaking have the same meanings in this agreement.

2 Consideration

2.1 Consideration

- (a) Each party enters into this agreement for valuable consideration from the other party and receipt of the consideration is acknowledged by each party.
- (b) Without limitation to **clause 2.1(a)**, each party agrees to pay to the other party \$1.00 on demand in consideration of that other party entering into this agreement.

2.2 No offer or acceptance for Transaction

This agreement and the disclosure of Confidential Information to the Recipient under this agreement is not an offer or acceptance of an offer to enter into the Transaction. Nothing in this agreement obliges any party to enter into the Transaction.

3 Confidentiality

Each party:

- (a) undertakes to keep confidential and not disclose any Confidential Information of the other party or permit any person employed or engaged by it to disclose any such Confidential Information to any person (including other individuals employed or engaged by that party) except in accordance with this agreement or the Undertaking;
- (b) undertakes to use the Confidential Information of the other party only for the Purpose;
- (c) must secure and protect the Confidential Information of the other party from unauthorised disclosure, access or use;
- (d) is responsible for any use or disclosure of Confidential Information of the other party which is contrary to the provisions of this agreement by persons to whom the Recipient discloses the Confidential Information;
- (e) must take all steps as may be necessary to prevent any improper use or disclosure (including enforcing any confidentiality deed or confidentiality provisions contained in another arrangement under which the Recipient disclosed that Confidential Information) of Confidential Information of the other party; and
- (f) must not copy or reduce into tangible, visible or recorded form or allow to be copied or reduced into tangible, visible or recorded form, any Confidential Information disclosed to it by the other party except to the extent necessary to carry out a Purpose.

4 Exceptions

- (a) **Clause 3(a)** does not apply to the Recipient under this agreement if the owner of the Confidential Information provides its prior written approval, which approval must not be unreasonably withheld.
- (b) **Clause 3(a)** does not apply to the Counterparty if the disclosure is:
 - (i) required or compelled by any Law;
 - (ii) required or compelled by any order of a court;
 - (iii) required or compelled by notice validly issued by any Authority;
 - (iv) necessary for the conduct of any legal proceedings, dispute resolution process or audit under the Undertaking, the Act or an agreement entered with Aurizon Network;
 - (v) if the process in **clause 4(d)** is observed, required under any stock exchange listing requirement or rule;
 - (vi) necessary for the effective response to an emergency or natural disaster or for clearing an incident or emergency that is preventing the operation of Train Services on the Rail Infrastructure; or
 - (vii) to the Safety Regulator.
- (c) **Clause 3(a)** does not apply to Aurizon Network if the disclosure is permitted by **clause 3.11** of the Undertaking and Aurizon Network complies with the process set out in that clause permitting disclosure of Confidential Information.
- (d) Prior to any disclosure under **clause 4(b)(v)**, the Counterparty must:
 - (i) consult with Aurizon Network as to the nature and extent of the disclosure of the Confidential Information;
 - (ii) accept any requests made by Aurizon Network (acting reasonably) to limit the disclosure of the Confidential Information; and
 - (iii) to the extent reasonably possible, coordinate the disclosure of the Confidential Information with any similar disclosure by Aurizon Network that is required under any stock exchange listing requirement or rule relating to Aurizon Network.
- (e) For the purposes of **clause 4(a)**, it is unreasonable for the owner of the Confidential Information to refuse to approve the disclosure of its Confidential Information by the Recipient to that Recipient's external consultants, independent advisers or, if the Recipient is an Access Seeker or Access Holder, to the Recipient's Customer or Train Operator, if the Recipient enters into a contract with the recipient of the Confidential Information which:

- (i) specifies:
 - (A) the persons employed by the recipient who may have access to any Confidential Information provided under the contract; and
 - (B) that those persons must not disclose any Confidential Information provided under the contract to any other person unless otherwise agreed by the Recipient and the owner of the Confidential Information; and
 - (ii) requires the recipient to execute a confidentiality deed in favour of the owner of the Confidential Information on terms and conditions substantially similar to this agreement;
 - (iii) advises the recipient that a conflict of interest may exist with respect to the recipient providing services on a related matter to a Related Operator or Related Competitor; and
 - (iv) requires that if the external consultant or independent advisor is also advising a Related Operator or Related Competitor in relation to the same or a related matter, the recipient to ensure that those individuals are not, and will not for as long as the information remains Confidential Information, be working for a Related Operator or Related Competitor on the same or a related matter.
- (f) If consent is sought by Aurizon Network under **clause 4(a)**:
- (i) during the process of responding to an Access Application or negotiating an Access Agreement:
 - (A) where such consent has been sought during the Negotiation Period and the owner of the Confidential Information fails to respond to Aurizon Network's request for consent within five Business Days of its receipt of Aurizon Network's written request (referred to as the **Consent Response Date**), then all relevant timeframes applicable to Aurizon Network under **Part 4** of the Undertaking will be extended by the same number of days as the day on which the response is given exceeds the Consent Response Date; or
 - (B) where such consent has been sought during the Negotiation Period and the owner of the Confidential Information unreasonably refuses its consent to the disclosure of that Confidential Information, or fails to respond to Aurizon Network's request for consent within 20 Business Days of its receipt of Aurizon Network's written request, then Aurizon Network may give a

Negotiation Cessation Notice to the Access Seeker, in accordance with **clause 4.13** of the Undertaking; or

- (ii) during the process of administering an Access Agreement or a Train Operations Deed, if the owner of the Confidential Information fails to respond to Aurizon Network's request for consent within twenty (20) Business Days of its receipt of Aurizon Network's written request, then consent is deemed to be given.

5 Counterparty's obligations

The Counterparty:

- (a) confirms it is aware of and understands the Aurizon Network's obligations regarding Confidential Information under the Undertaking;
- (b) acknowledges it may not provide the Confidential Information received from Aurizon Network to any other party, including any person employed or engaged by it, without the consent of Aurizon Network and then only on the terms and conditions required by Aurizon Network (acting reasonably);
- (c) confirms it must secure and protect the Confidential Information received from Aurizon Network from unauthorised disclosure, access or use;
- (d) consents to Aurizon Network recording in the Confidential Information Register all information required by the Undertaking in respect of its use of the Confidential Information;
- (e) agrees to provide any information requested by Aurizon Network to enable it to complete the Confidential Information Register; and
- (f) agrees to attend any training course required by Aurizon Network (acting reasonably) in respect of the Counterparty's use and management of the Confidential Information.

6 Aurizon Network obligations

Aurizon Network agrees to comply with all obligations of Aurizon Network under **Part 3** of the Undertaking relating to Confidential Information, subject to the exceptions, exclusions and permitted disclosures of Confidential Information in the Undertaking.

7 Breach of agreement

- (a) The owner of the Confidential Information may take legal proceedings against the Recipient and/or any third party if there is any actual, threatened or suspected breach of this agreement.

- (b) The parties acknowledge that damages may be inadequate compensation for breach of this agreement and, subject to the court's discretion, the owner of the Confidential Information may seek specific performance of this agreement and may restrain, by an injunction or similar remedy, any conduct or threatened conduct which is or will be a breach of this agreement.

8 Termination

- (a) This agreement terminates on:
 - (i) the execution by the parties of:
 - (A) the document containing the terms of the Transaction; or
 - (B) a subsequent confidentiality agreement imposing confidentiality obligations on Aurizon Network in respect of the Confidential Information; or
 - (ii) in the case of an Access Agreement or Train Operations Deed:
 - (A) the cessation of negotiations in respect of the Transaction, in accordance with the Undertaking; or
 - (B) the withdrawal by the Discloser of its Access Application relating to the Transaction.
- (b) Where termination occurs under **clause 8(a)(i)**, this agreement terminates immediately.
- (c) Where termination occurs under **clause 8(a)(ii)(A) or (B)**, this agreement terminates immediately on the date specified in Item 6 of Schedule 1.
- (d) To the extent permitted by law and subject to the provisions of this agreement, neither party may terminate this agreement and in no other circumstance or event may this agreement be terminated.

9 Notices

9.1 Form of Notice

Any notice, demand, invoice, process or other communication relating to this agreement (**Notice**) must be in English and may be given by an agent of the sender and may, if agreed by Aurizon Network, be in electronic form.

9.2 Method of giving Notices

A Notice may be given by being:

- (a) personally delivered to a party;
- (b) left at the party's current delivery address for service;

- (c) sent to the party's current postal address for service by pre-paid ordinary mail;
- (d) sent by facsimile transmission to the party's current facsimile number for service; or
- (e) if agreed by Aurizon Network, sent by email to the party's current email address for service.

9.3 Particulars for giving of Notices

The particulars for giving of Notices are detailed in **items 4-5** of **Schedule 1**, or as most recently notified to the party sending the Notice.

9.4 Notice by post

Subject to **clause 9.7**, a Notice is given if posted:

- (a) within Australia to an Australian postal address, three Business Days after posting; or
- (b) outside of Australia to an Australian postal address or within Australia to an address outside of Australia, ten (10) Business Days after posting.

9.5 Notice by fax

Subject to **clause 9.7**, a Notice is given if sent by fax, when the sender's fax machine produces a report that the fax was sent in full to the addressee. That report is conclusive evidence that the addressee received the fax in full at the time indicated on that report.

9.6 Notice by email

Subject to **clause 9.7**, a Notice is given if sent by email, on the next Business Day after being sent (as recorded on the device from which the sender sent the email) unless the sender receives an automated message that the email has not been delivered.

9.7 After hours Notice

If a Notice is given:

- (a) after 5:00pm in the place of receipt; or
- (b) on a day which is a Saturday, Sunday or bank or public holiday in the place of receipt,

it is taken as having been given at 9:00 am on the next day which is not a Saturday, Sunday or bank or public holiday in that place.

10 General

10.1 No licence

This agreement does not grant the Recipient any licence or other rights relating to any Confidential Information or other intellectual property rights owned by the owner of the Confidential Information.

10.2 Variation

No provision of this agreement may be varied other than in writing executed by the parties to this agreement.

10.3 No assignment

No party may assign, transfer, charge or deal in any other way with the benefit of any right (or agree to do so), or create or declare (or agree to do so), or allow to arise, any trust in respect of the benefit of any right conferred by or arising under this agreement without the prior consent in writing of the other party.

10.4 Costs

The parties agree to pay their own legal and other costs and expenses in connection with the preparation, execution and completion of this agreement.

10.5 Counterparts

This agreement may be executed in any number of counterparts. All counterparts together will be taken to constitute one agreement.

10.6 Effect of execution

This agreement is not binding on any party unless it or a counterpart has been duly executed by each person named as a party to this agreement.

10.7 Construction

In this agreement:

- (a) any schedule and annex to it is an integral part of it and any reference to this agreement includes a reference to that schedule and annex;
- (b) the headings in it are used for ease of reference only and are not to be taken into account for the purposes of construing it;
- (c) any reference to it or any other agreement, contract, document or instrument includes any variation or replacement of any of them;
- (d) any references to any clause, schedule, annex and provision are references to that clause, schedule, annex and provision contained in it;
- (e) the words 'including', 'include' and 'includes' are to be construed as if followed by the words 'without limitation';

- (f) a reference to a person includes any company, partnership, joint venture, unincorporated association, corporation or other body corporate and a government or statutory body or authority;
- (g) words in the singular include the plural and vice versa; and
- (h) if a word or phrase is defined its other grammatical forms have corresponding meanings.

11 Governing law and jurisdiction

This agreement is governed by the laws applicable in Queensland and each party submits to the non-exclusive jurisdiction of the courts exercising jurisdiction in Queensland and any court competent to hear appeals from any of those courts.

Schedule 1

Reference Schedule

Item	Description	Details
1	Counterparty	Name: [insert] ABN: [insert] Address: [insert]
2	Purpose	[insert] [If for negotiation of an Access Agreement or Train Operations Deed, insert: "To facilitate the negotiations in respect of the potential granting of Access by Aurizon Network under an Access Agreement or the use of that Access under a Train Operations Deed (as applicable).]
3	Transaction	[insert] [If for negotiation of an Access Agreement or Train Operations Deed, insert: "The execution of an Access Agreement or Train Operations Deed (as applicable) under which Aurizon Network agrees to provide the Counterparty with Access (under an Access Agreement) or the right to use that Access (under a Train Operations Deed).]
4	Particulars for giving Notices	Aurizon Network Delivery address: [insert] Postal address: [if there is no PO box, insert 'Same as delivery address'] Facsimile: [insert] Email address: [insert] Attention: [insert]
5		Counterparty Delivery address: [insert] Postal address: [if there is no PO box, insert 'Same as delivery address'] Facsimile: [insert] Email address: [insert] Attention: [insert]
6	Termination date	The date that is [insert] Months after an event in clause 8(a)(i) or (ii) occurs.

Execution

Executed as an agreement.

[Appropriate execution blocks to be inserted]

Schedule J

Coal loss mitigation provisions

1 Coal loss mitigation - general coal loading, unloading, profiling and veneering obligations

1.1 Background to Coal Loss Mitigation Provisions

- (a) Across the Central Queensland coal supply chain, participants:
- (i) are committed to implementing a range of effective dust mitigation strategies including operational procedures and the application of new techniques to improve awareness and reduce the risk of environmental harm, while ensuring this aspect of the coal supply chain network continues to have community support³³; and
 - (ii) recognise the need for industry 'best practice' to mitigate coal dust, and that a whole-of-supply chain approach should provide the most effective mitigation approach to coal dust³⁴.
- (b) The following actions have been identified as 'best practice' and have proven, through extensive research and testing, to be highly effective in minimising potential dust impacts³⁵:
- (i) **(Moisture content management)** Coal producers wash their coal or blend it to achieve an optimum moisture level which reduces dust and achieves market qualities.
 - (ii) **(Improved loading practices)** Improved loading practices can reduce coal deposits on coal wagon ledges and wheel surfaces that are prone to spillage during transport. It also supports the ability to create a consistent surface of coal in each wagon.
 - (iii) **(Load profiling of coal surface)** The profile of the loaded coal wagon refers to the shape of the exposed surface of coal on the top of in the wagon. A flat surface with gradually sloping sides is a tried and proven method of dust suppression.
 - (iv) **(Veneering)** Veneering is the application of a biodegradable polymer onto the surface of the loaded coal. The veneer forms a crust over the coal load, which along with the use of

³³ CDMP, paragraph 2.

³⁴ CDMP, paragraph 1.3.

³⁵ Coal dust management plan for the South West System, released in November 2013.

- a modified loading chute suggests that a significant reduction in coal dust lift-off from wagons is achievable.
- (v) **(Ongoing dust monitoring)** Commitment to a program of ongoing dust monitoring to validate the effectiveness of mitigation measures and confirm that dust levels, particularly coal dust levels, continue to meet environmental standards.
 - (c) The principal objective of the Coal Loss Mitigation Provisions is the Prevention of Coal Loss in an effort to achieve 'best practice'.
 - (d) The significant strategies to achieve the Prevention of Coal Loss are the loading, profiling and veneering of wagons in accordance with the Standards, and implementation timeframes, provided under the Coal Loss Mitigation Provisions. This includes:
 - (i) meeting the Queensland Department of Environment and Heritage Protection's targets for coal dust emissions from wagons;
 - (ii) no parasitic or fugitive coal (other than coal dust to standard) falling from wagons; and
 - (iii) meeting height and weight requirements in relation to the loading of wagons to protect below rail assets.
 - (e) The Private Infrastructure Owner as the loading practitioner has primary responsibility to ensure wagons are loaded, profiled and veneered in a manner that achieves the Prevention of Coal Loss, and this is reflected in the Coal Loss Mitigation Provisions.

1.2 Definitions

In this **Schedule J**:

CDMP means Aurizon Network's Coal Dust Management Plan dated 22 February 2010 as approved by the Department of Environment and Heritage Protection in May 2010;

Loading Breach means, in respect of a train, a breach of **clause 1** or **clause 2** of this **Schedule J** relating to the loading of coal into the train, the veneering and profiling of coal loaded into the train and the unloading of coal from the train at the Transfer Facilities;

Preventing Coal Loss has the meaning given to the term in **clause 1.3** of this **Schedule J**;

Private Land has the meaning given to the term in the Standard Rail Connection Agreement.

Quality Management System includes the system by which the Private Infrastructure Owner manages the quality of its coal loading operations at the Transfer Facilities;

Rectification Notice has the meaning given in **clause 1.7(a)** of this **Schedule J**;

Standards has the meaning given in **clause 1.3(a)** of this **Schedule J**;

Suspension Notice has the meaning given in **clause 1.7(d)** of this **Schedule J**;

Transfer Facilities means any coal loading facilities which utilise the Private Infrastructure and any alterations, additions and replacements of such facilities made by the Private Infrastructure Owner from time to time.

1.3 Meaning of Preventing Coal Loss

(a) In the Coal Loss Mitigation Provisions, **Preventing Coal Loss** means taking all reasonable and practicable measures during the handling and loading of coal at the Transfer Facilities to prevent coal loss (including emissions of coal dust and spillage from wagons) during the transport of such coal by rail on the Connecting Infrastructure or the Rail Infrastructure to satisfy (subject to **clause 1.3(b)** of this **Schedule J**) the standards, targets, levels or other measures (**Standards**) set for coal loss:

- (i) in accordance with all applicable laws; and
- (ii) in accordance with all requirements, instructions, guidelines, standards or other directions whether now or at any time in the future in effect issued or published by an Authority responsible for the administration of Environmental Laws in Queensland,

and references to **Prevents Coal Loss**, **Prevent Coal Loss** and **Prevention of Coal Loss** must be interpreted in a corresponding way.

(b) If any one or more of the Standards referred to in **clause 1.3(a)** of this **Schedule J** cannot be complied with without failing to comply with another applicable Standard, then as between those mutually inconsistent Standards, Standards referred to in **clause 1.3(a)(i)** of this **Schedule J** prevail over Standards referred to in **clause 1.3(a)(ii)** of this **Schedule J**.

1.4 General obligation

(a) Notwithstanding any other provision in the Coal Loss Mitigation Provisions, the Private Infrastructure Owner must, at all times, and without adversely affecting the capacity of the Supply Chain, use its reasonable endeavours to Prevent Coal Loss, taking into account factors which include (but are not limited to):

- (i) prevailing business conditions at the time any decision to implement a mitigation strategy is required;
- (ii) the effectiveness of the particular mitigation approach given technology and cost constraints;
- (iii) the timeframes required to implement mitigation strategies;

- (iv) the overall strategy undertaken given the specific characteristics underlying the relevant owner's contribution to dust; and
- (v) consideration of the impact on other Supply Chain Participants,

(collectively, the **Limiting Factors**).

- (b) For the avoidance of doubt, the Private Infrastructure Owner will not be taken to have failed to Prevent Coal Loss in respect of the spillage of coal from a wagon during the transport of the coal by rail if the spillage is caused by the malfunction of the wagon's kwik drop doors.
- (c) Without limiting any other obligation of the Private Infrastructure Owner under the Agreement, the Private Infrastructure Owner must comply with:
 - (i) all applicable Laws relating to coal loss (including the emission of coal dust);
 - (ii) all requirements, instructions, guidelines, standards or other directions relating to coal loss (including the emission of coal dust) whether now or at any time in the future in effect which would customarily be observed by a reasonable and prudent owner or operator of facilities such as the Transfer Facilities (including any such things issued or published by an Authority responsible for the administration of environmental Laws in Queensland); and
 - (iii) the Private Infrastructure Owner's obligations and the standards and requirements set out in this **Schedule J** (including the rail asset restrictions specified by Aurizon Network from time to time),

during the handling, loading and unloading of coal using the Transfer Facilities.

- (d) The Private Infrastructure Owner must supply any labour, materials, plant, equipment and facilities required to enable it to properly perform its obligations under the Coal Loss Mitigation Provisions.

1.5 Obligation to install and operate veneering equipment

- (a) Without limiting any other obligation of the Private Infrastructure Owner under this **clause 1** of **Schedule J**, the Private Infrastructure Owner must use reasonable endeavours to, at its cost:
 - (i) install (or procure the installation of) suitable veneering equipment as part of the Transfer Facilities; and
 - (ii) after the veneering equipment is installed:
 - (A) operate (or procure the operation of) the veneering equipment; and

- (B) ensure an effective veneering agent is applied onto the exposed surface of coal loaded into wagons at the Transfer Facilities,

for the purpose of Preventing Coal Loss during transport except that it is reasonable for the Private Infrastructure Owner to not do some or all of the above as a result of the Limiting Factors.
- (b) Without limitation to **clause 1.5(a)(ii)(B)** of this **Schedule J**, the veneering agent applied in accordance with **clause 1.5(a)(ii)(B)** must:
 - (i) be applied to all loaded wagons;
 - (ii) achieve a nil dust lift off from loaded wagons regardless of coal type;
 - (iii) remain intact from the time the train enters the Rail Infrastructure until the time the train is unloaded;
 - (iv) meet the requirements of all relevant environmental Laws; and
 - (v) be accepted at the relevant unloading destination to permit unloading of wagons.
- (c) The Private Infrastructure Owner will not use or permit the use of any veneering agent, or a change in the properties of any veneering agent, without first providing to Aurizon Network the following documents and information, which must be acceptable to Aurizon Network:
 - (i) Material Data Safety Sheet;
 - (ii) toxicology reports detailing the physical and chemical makeup of the product, the effects and impact of the product and components on humans, fauna, flora, wildlife and whole ecosystems; and
 - (iii) a full list of constituents.

1.6 Monitoring

- (a) Without limiting any other provisions of the Agreement, and upon giving not less than two (2) Business Days' notice to the Private Infrastructure Owner, Aurizon Network is entitled:
 - (i) to enter and be upon Private Land:
 - (A) once every twelve (12) Months; and
 - (B) at any other time, upon receipt of consent from the relevant owner to enter and be upon Private Land, provided that Aurizon Network, acting reasonably, has formed the opinion that the Private Infrastructure Owner is not complying with its obligations under this **clause 1** of **Schedule J**; and

- (ii) to access the Transfer Facilities (including the veneering equipment),

to enable Aurizon Network, from time to time:

- (iii) to verify compliance by the Private Infrastructure Owner with its obligations under this **clause 1** of this **Schedule J**; and
- (iv) to investigate the effectiveness of the veneering equipment (and its operation) or any other measures (including the veneering agent) used by the Private Infrastructure Owner in connection with any matters referred to in **clauses 1.4** or **1.5** of this **Schedule J**,

and the Private Infrastructure Owner must also provide any reasonable assistance requested by Aurizon Network in respect of such matters (including, if requested by Aurizon Network, providing evidence from the Private Infrastructure Owner's Quality Management System or other similar system verifying the Private Infrastructure Owner's compliance with the Coal Loss Mitigation Provisions).

- (b) For the avoidance of doubt, a reference to Aurizon Network in **clause 1.6(a)** of this **Schedule J** includes a reference to the employees, agents and contractors of Aurizon Network and any third party authorised by Aurizon Network.
- (c) If Aurizon Network accesses Private Land under **clause 1.6(a)** of this **Schedule J**, Aurizon Network must, and must procure that its representatives and contractors who access the Private Land:
 - (i) comply with:
 - (A) all site and safety rules applicable to the Private Land as notified by the Private Infrastructure Owner or the owner of the Private Land prior to such access;
 - (B) any reasonable direction given by any representative of the Private Infrastructure Owner or the owner of the Private Land; and
 - (C) any other reasonable conditions specified by the Private Infrastructure Owner or the owner of the Private Land; and
 - (ii) minimise interference with the Private Infrastructure Owner's activities to the extent possible.
- (d) Aurizon Network will monitor the Private Infrastructure Owner's compliance with its obligations under this **clause 1** of **Schedule J** through, without limitation:
 - (i) the installation of coal dust monitoring equipment at various locations on the Rail Infrastructure;

- (ii) periodic assessment of the Private Infrastructure Owner's impact on coal fouling across the Rail Infrastructure; and
- (iii) the periodic observation of:
 - (A) the Private Infrastructure Owner's coal loading, profiling, veneering and other operations at the Transfer Facilities; and
 - (B) trains loaded at the Transfer Facilities during transport.
- (e) Aurizon Network must at its cost ensure that any coal dust monitoring equipment used by Aurizon Network to monitor the Private Infrastructure Owner's compliance with its obligations under this **clause 1 of Schedule J** are in proper working order and calibrated.
- (f) Within 10 Business Days after end of each Quarter, Aurizon Network will provide the Private Infrastructure Owner with a written report in respect of Aurizon Network's monitoring of Private Infrastructure Owner's compliance with its obligations under this **clause 1 of Schedule J** during that Month (together with supporting information in respect of any non-compliance detected by Aurizon Network).

1.7 Suspension of rights

- (a) If the Private Infrastructure Owner fails to carry out an obligation under the Coal Loss Mitigation Provisions, Aurizon Network may give the Private Infrastructure Owner a notice (**Rectification Notice**) requiring the Private Infrastructure Owner to:
 - (i) in the case of any default which is capable of remedy, remedy the default; and
 - (ii) in the case of a default which is not capable of remedy, take reasonable steps to prevent the reoccurrence of the event or circumstance that resulted in the default,

within the period (which must be at least 90 days) specified in the Rectification Notice.
- (b) If a Rectification Notice is given to the Private Infrastructure Owner under **clause 1.7(a)**, Aurizon Network and the Private Infrastructure Owner must meet to discuss and agree upon a reasonable program (having regard to the Limiting Factors) setting out the activities, and a timetable to undertake those activities, required to prevent the reoccurrence of the event or circumstance that resulted in default.
- (c) The Private Infrastructure Owner will keep Aurizon Network informed of the activities undertaken to comply with the Rectification Notice.
- (d) If the Private Infrastructure Owner does not comply with a Rectification Notice within the time required by the Rectification Notice then Aurizon Network may give the Private Infrastructure Owner a notice (**Suspension Notice**), suspending the Private Infrastructure

Owner's rights under the Agreement and any other agreement to utilise, and to authorise or allow others to utilise, the Connecting Infrastructure for the passage of loaded coal trains.

- (e) A Suspension Notice must specify that it is a notice given under **clause 1.7(d)** of this **Schedule J**.
- (f) A suspension of the Private Infrastructure Owner's rights in accordance with **clause 1.7(a)** of this **Schedule J** will continue until the earlier of the following dates:
 - (i) if the relevant default is capable of remedy, the date that the Private Infrastructure Owner does the things specified in **clause 1.7(a)(i)** of this **Schedule J**;
 - (ii) if the relevant default is not capable of remedy, the date that the Private Infrastructure Owner does the things specified in **clause 1.7(a)(ii)** of this **Schedule J**;
 - (iii) if Aurizon Network notifies the Private Infrastructure Owner of the cessation of the suspension, the date which Aurizon Network notifies the Private Infrastructure Owner as the date on which the suspension will cease.
- (g) If Aurizon Network exercises its right of suspension under **clause 1.7(a)** of this **Schedule J** and the Private Infrastructure Owner disputes the exercise of that right by Aurizon Network, the suspension will not take effect unless the Dispute is resolved in favour of Aurizon Network during the period of the Dispute resolution process under in accordance with **Part 11** (at which time, the suspension will take effect);
- (h) The exercise by Aurizon Network of its rights and remedies under this **clause 1.7** of **Schedule J** does not limit or restrict Aurizon Network from exercising, at any time, any other rights or remedies of Aurizon Network in respect of the relevant default (including its rights of termination under Clause 20 of the Standard Rail Connection Agreement).

1.8 Reporting

- (a) Within 15 Business Days after the end of each Quarter, the Private Infrastructure Owner must submit a written report (in the form reasonably required by Aurizon Network) to Aurizon Network in respect of any material non-compliance by the Private Infrastructure Owner with an obligation of Private Infrastructure Owner under the Coal Loss Mitigation Provisions, provided always that such reporting obligation only applies to the strategies the Private Infrastructure Owner is able to implement to Prevent Coal Loss as have been agreed between the parties.
- (b) Without limiting **clause 1.8(a)** of this **Schedule J**, within five Business Days after the occurrence of any of the following events, the Private

Infrastructure Owner must submit a written report to Aurizon Network providing reasonable details in respect of the event:

- (i) the breakdown of, or the inability to operate, any veneering equipment;
 - (ii) any damage to the Rail Infrastructure in connection with any non-compliance by the Private Infrastructure Owner with its obligations under the Coal Loss Mitigation Provisions;
 - (iii) any event arising in connection with any non-compliance by the Private Infrastructure Owner with its obligations under the Coal Loss Mitigation Provisions which interferes, or may interfere, with the proper functioning or operation of the Rail Infrastructure; and
 - (iv) any event that results, or is likely to result, in the Private Infrastructure Owner being unable to perform a material obligation under the Coal Loss Mitigation Provisions.
- (c) The Private Infrastructure Owner must:
- (i) maintain a record of the operation of the veneering equipment, including the dates and times of operation (**Veneering Log**); and
 - (ii) provide a copy of the Veneering Log to Aurizon Network within 24 hours of receiving a request from Aurizon Network to view the Veneering Log.

1.9 Continuous improvement

The Parties must meet at least once each Quarter to discuss:

- (a) the effectiveness of the then current practices for preventing coal loss; and
- (b) new or modified practices which could be implemented to improve the prevention of coal loss,

and use their reasonable endeavours to achieve 'best practice' (subject to the Limiting Factors, cost constraints and the potential impact on other Supply Chain Participants), including (but not limited to) giving due consideration to:

- (c) the "Coal Producers Dust Mitigation Activities" outlined in **Table 3.1.2** and Annexure B of the CDMP; and
- (d) the actions that have been identified as 'best practice' specified in **clause 1.1(b)** of this **Schedule J**.

2 Coal loading, profiling and veneering

2.1 Coal Loss Management

- (a) The Private Infrastructure Owner must be able to demonstrate its compliance with its obligations under this **Schedule J** through its

Quality Management System, but only to the extent it is able to implement strategies to Prevent Coal Loss.

- (b) The Private Infrastructure Owner must consider current best industry practice with respect to Preventing Coal Loss when choosing an appropriate loading methodology. Best industry practice at this date of this Agreement includes matters such as:
- (i) operating procedure review and training to reduce the sources of coal loss;
 - (ii) Quality Management System procedures and reporting to enable a 'lessons learnt' approach;
 - (iii) inbound wagon identification system to determine class of wagon about to be loaded;
 - (iv) inbound overload detection devices to measure the tare weight of each incoming wagon;
 - (v) batch weighing system to load the correct amount of coal into each wagon;
 - (vi) telescopic loading chute to profile the load in each wagon or, as an interim measure until such a chute is operating effectively, a suitable profiling blade on the exit side of the load-out;
 - (vii) outbound overload detection devices to measure the gross and bogey weights of each outgoing wagon;
 - (viii) volumetric scanning to measure the profile of each outgoing wagon; and
 - (ix) veneering spray stations on exit side of load-out (after profiling has been achieved).

2.2 General Management of Coal Loading

- (a) The Private Infrastructure Owner, in loading wagons at the Transfer Facilities, must comply with:
- (i) the wagon design maximum load and volume for wagons and the network asset restrictions including height and weight requirements specified by Aurizon Network from time to time; and
 - (ii) the rail asset restrictions specified by Aurizon Network from time to time.
- (b) The Private Infrastructure Owner must ensure the design of the Transfer Facilities and its adoption of suitable loading and unloading methodologies each achieve the following:
- (i) loading to an appropriate profile and clearance to Prevent Coal Loss en route to the unloading facilities; and

- (ii) Prevent Coal Loss from the wagons after entering the Rail Infrastructure.
- (c) The Private Infrastructure Owner must use reasonable endeavours to ensure that coal is loaded into wagons in a manner which ensures that the coal (including coal dust) cannot leave the wagon until it is unloaded from the wagon at an unloading facility.

2.3 Loading and profiling of wagons

- (a) The Private Infrastructure Owner must ensure the loading methodology (including the approach to coal profiling) chosen by the Private Infrastructure Owner Prevents Coal Loss. The Private Infrastructure Owner must demonstrate to Aurizon Network that its adopted loading methodology Prevents Coal Loss and complies with the rail asset restrictions specified by Aurizon Network from time to time.
- (b) Without limitation to the Private Infrastructure Owner's obligations regarding the loading methodology, the Private Infrastructure Owner and Aurizon Network must agree upon suitable profiling requirements having regard to the Limiting Factors, using the following requirements as 'best practice' that should be achieved (if possible):
 - (i) Prevent the loading of coal to the very edges and ends of the wagons leaving sufficient "freeboard" (i.e: - not loaded to top of wagon side) at the sides and ends of loaded wagons to Prevent Coal Loss. See **Figure 1**~~Figure-4~~ below.
 - (ii) The method of loading must ensure that loading is even over the length and width of each wagon up to the maximum allowable height as specified by Aurizon Network from time to time (currently 3950mm above rail level). However, achieving loading to this height and shape is ultimately dependant on the density of coal being transported, provided that the profile must have a flat surface and spillage over the sides must be avoided.

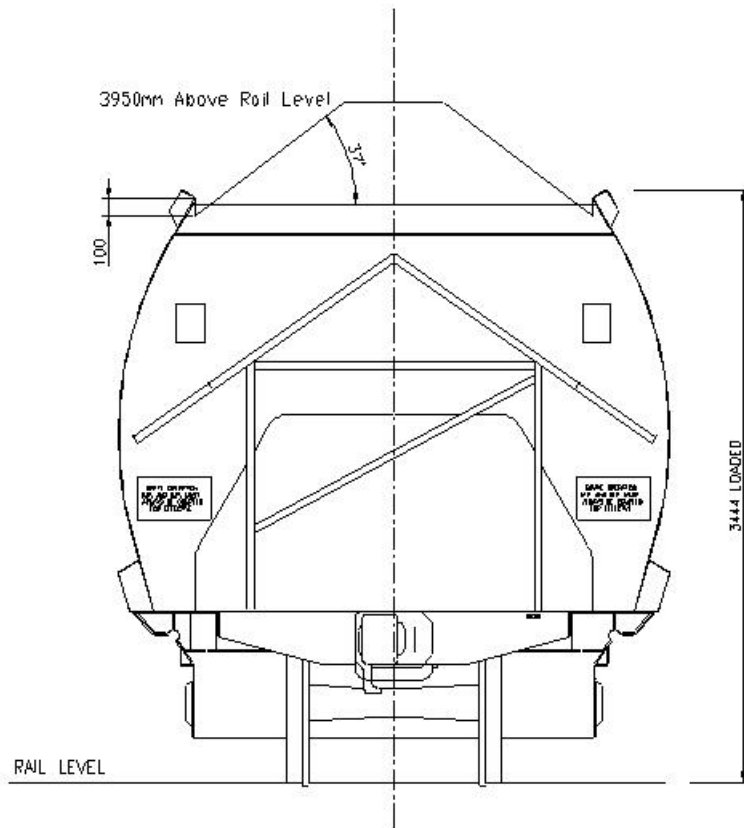

Figure 1 - End View of wagon showing maximum allowable loading profile requirements.

- (c) A suitable profiler must be used to profile the coal so as to result in a loaded wagon with a coal profile that optimises the effectiveness of veneering agents applied in order to Prevent Coal Loss. Without limiting the type of profile that the Private Infrastructure Owner may adopt, an appropriately designed and maintained telescopic loading chute can achieve a 'garden-bed' profile (standard loading profile as shown in [Figure 2](#) below) to mitigate the risk of coal lift-off and to optimise the effectiveness of veneering agents applied in order to Prevent Coal Loss.



Figure 2 - Top of loaded coal wagon showing 'Garden Bed' style profile.

- (d) The loading chute and associated skirts must achieve a slope on the side of the load less than the natural angle of repose of the coal and must ensure the product is not left on the wagon sills (side and end).
- (e) To the extent the Private Infrastructure Owner is able to implement strategies to Prevent Coal Loss that do not use the loading methods outlined in this **clause 2.3**, the Private Infrastructure Owner must not permit the loading of coal into wagons from:
 - (i) front-end loaders; or
 - (ii) Clam shell type loading facilities.

2.4 Parasitic and fugitive coal removed from wagons

Unless otherwise agreed by Aurizon Network, the Private Infrastructure Owner must use reasonable endeavours to remove any visible coal that has fallen onto wagon sills and surfaces or running gear immediately after the coal is loaded, in order to avoid the risk of coal falling off the wagon during transit.

2.5 Kwik Drop Doors (KDDs)

The Private Infrastructure Owner is responsible for the type of coal loaded into the wagons. The Private Infrastructure Owner must use reasonable endeavours to ensure that coal fineness and moisture content will not facilitate coal loss via the KDDs during transportation from the Transfer Facilities to the unloading facility.

Schedule K

Total CQCN (\$m)	FY18 \$m	FY19 \$m	FY20 \$m	FY21 \$m	FY22 \$m	FY23 \$m
Capital Indicator	218.7	190.0	232.2	231.0	231.0	231.0
Return on Capital	341.9	345.3	361.8	372.1	368.5	364.0
Return of Capital <i>minus</i> Inflation	246.4	245.2	304.0	278.3	294.8	290.9
Direct Maintenance Costs	223.7	205.7	155.1	158.1	158.1	158.1
Indirect Maintenance Cost Allowance	9.1	9.5	10.8	10.2	10.2	10.2
Electric Operating Expenditure Allowance	70.2	59.7	57.2	60.6	62.4	64.2
Non-Electric Operating Expenditure Allowance	117.4	120.7	132.7	135.1	135.1	135.1
Tax Allowance	38.5	38.0	54.9	54.6	51.9	51.1
Capital Carryover	0	0	6.0	6.2	6.3	6.5
Allowable Revenue	1,047.2	1,024.1	1,082.5	1,075.2	1,087.2	1,080.0

Values by Coal System

NB: the Allowable Revenues at an individual Coal System level below may vary to those published in Schedule F. Schedule F Allowable Revenues will:

- (a) exclude revenue recoverable through the AT1 Reference Tariff;
- (b) account for revenue allocations between the Blackwater and Goonyella systems as a result of forecast cross-system traffic;
- (c) incorporate the impact of the reconciliation of FY2018 and FY2019 transitional arrangements;
- (d) incorporate the impact of the annual review of Reference Tariffs;
- (e) incorporate the impact of Revenue Adjustment Amounts; and
- (f) incorporate the impact of any Review Event or Endorsed Variation Event that occurs after the Initial Date.

Blackwater - Non-Electric (\$m)	FY18	FY19	FY20	FY21	FY22	FY23
Capital Indicator	95.4	78.1	102.3	106.8	106.8	106.8
Return on Capital*	132.4	132.0	139.4	144.4	143.9	143.1
Return of Capital <i>minus</i> Inflation	98.1	90.0	116.7	107.6	116.2	113.0
Direct Maintenance Costs	86.6	86.0	59.8	62.0	62.0	62.0
Indirect Maintenance Cost Allowance	3.9	4.1	4.9	4.6	4.6	4.6
Electric Operating Expenditure Allowance	0	0	0	0	0	0
Non-Electric Operating Expenditure Allowance	46.6	47.3	52.4	53.9	53.9	53.9
Tax Allowance	14.2	13.1	20.6	21.2	19.8	19.1
Capital Carryover	0	0	1.7	1.8	1.8	1.9
Allowable Revenue	381.7	372.5	395.6	395.5	402.3	397.6

* working capital is added to Return on Capital.

Blackwater - Electric (\$m)	FY18	FY19	FY20	FY21	FY22	FY23
Capital Indicator	2.6	5.0	4.1	6.0	6.0	6.0
Return on Capital*	24.7	24.3	24.8	25.2	24.5	23.7
Return of Capital <i>minus</i> Inflation	14.5	15.5	16.6	17.8	19.0	20.3
Direct Maintenance Costs	4.6	4.6	4.7	4.8	4.8	4.8
Indirect Maintenance Cost Allowance	0.1	0.1	0.1	0.1	0.1	0.1
Electric Operating Expenditure Allowance	34.1	24.0	25.7	27.2	28.0	28.8
Non-Electric Operating Expenditure Allowance	0	0	0	0	0	0
Tax Allowance	1.7	2.0	2.5	3.0	3.2	3.4
Capital Carryover	0	0	(0.0)	(0.0)	(0.0)	(0.0)
Allowable Revenue	79.7	70.6	74.4	78.0	79.5	81.0

* working capital is added to Return on Capital.

Goonyella - Non-Electric (\$m)	FY18	FY19	FY20	FY21	FY22	FY23
Capital Indicator	89.5	74.9	95.5	93.0	93.0	93.0
Return on Capital*	90.0	90.6	96.7	100.8	102.0	103.2
Return of Capital <i>minus</i> Inflation	70.6	67.4	90.2	70.8	71.5	66.2
Direct Maintenance Costs	95.2	81.8	56.5	58.8	58.8	58.8
Indirect Maintenance Cost Allowance	4.0	4.2	4.6	4.3	4.3	4.3
Electric Operating Expenditure Allowance	0	0	0	0	0	0
Non-Electric Operating Expenditure Allowance	53.1	53.5	58.2	58.8	58.8	58.8
Tax Allowance	11.0	10.0	16.0	13.5	11.7	10.7
Capital Carryover	0	0	2.3	2.3	2.4	2.4
Allowable Revenue	323.9	307.5	324.5	309.3	309.5	304.4

* working capital is added to Return on Capital.

Goonyella - Electric (\$m)	FY18	FY19	FY20	FY21	FY22	FY23
Capital Indicator	3.1	6.6	5.6	5.9	5.9	5.9
Return on Capital*	14.0	14.0	14.5	14.9	14.6	14.3
Return of Capital <i>minus</i> Inflation	8.7	8.6	9.3	10.0	10.7	11.5
Direct Maintenance Costs	5.5	5.6	5.7	5.8	5.8	5.8
Indirect Maintenance Cost Allowance	0.1	0.1	0.1	0.1	0.1	0.1
Electric Operating Expenditure Allowance	36.1	35.7	31.5	33.4	34.3	35.3
Non-Electric Operating Expenditure Allowance	0	0	0	0	0	0
Tax Allowance	1.3	1.4	1.6	1.8	1.9	2.1
Capital Carryover	0	0	1.6	1.7	1.7	1.7
Allowable Revenue	65.7	65.3	64.2	67.6	69.2	70.9

* working capital is added to Return on Capital.

Moura - Non-Electric (\$m)	FY18	FY19	FY20	FY21	FY22	FY23
Capital Indicator	9.1	14.6	14.7	10.6	10.6	10.6
Return on Capital*	15.0	18.4	19.6	20.4	20.3	20.2
Return of Capital <i>minus</i> Inflation	7.1	9.2	11.8	11.5	12.8	12.9
Direct Maintenance Costs	12.2	12.9	12.0	12.2	12.2	12.2
Indirect Maintenance Cost Allowance	0.2	0.1	0.1	0.1	0.1	0.1
Electric Operating Expenditure Allowance	0	0	0	0	0	0
Non-Electric Operating Expenditure Allowance	3.8	4.8	5.7	5.8	5.8	5.8
Tax Allowance	2.1	2.1	2.9	3.1	2.8	2.8
Capital Carryover	0	0	0.4	0.4	0.4	0.4
Allowable Revenue	40.3	47.6	52.5	53.5	54.4	54.4

* working capital is added to Return on Capital.

Newlands - Non-Electric (\$m)	FY18	FY19	FY20	FY21	FY22	FY23
Capital Indicator	13.2	10.5	8.4	6.7	6.7	6.7
Return on Capital*	11.8	12.0	12.5	12.9	12.8	12.6
Return of Capital <i>minus</i> Inflation	8.0	8.6	9.4	8.5	9.2	9.3
Direct Maintenance Costs	4.3	3.1	2.8	2.9	2.9	2.9
Indirect Maintenance Cost Allowance	0.3	0.4	0.5	0.5	0.5	0.5
Electric Operating Expenditure Allowance	0	0	0	0	0	0
Non-Electric Operating Expenditure Allowance	3.1	3.3	3.6	3.6	3.6	3.6
Tax Allowance	1.7	1.7	1.9	1.9	1.9	1.9
Capital Carryover	0	0	0.8	0.8	0.8	0.9
Allowable Revenue	29.2	29.1	31.6	31.1	31.7	31.7

* working capital is added to Return on Capital.

GAPE - Non-Electric (\$m)	FY18	FY19	FY20	FY21	FY22	FY23
Capital Indicator	5.9	0.2	1.7	1.9	1.9	1.9
Return on Capital*	54.0	54.1	54.2	53.5	50.3	46.9
Return of Capital <i>minus</i> Inflation	39.5	45.9	50.1	52.2	55.4	57.7
Direct Maintenance Costs	15.3	11.6	11.4	11.6	11.6	11.6
Indirect Maintenance Cost Allowance	0.5	0.5	0.5	0.5	0.5	0.5
Electric Operating Expenditure Allowance	0	0	0	0	0	0
Non-Electric Operating Expenditure Allowance	10.9	11.8	12.8	12.9	12.9	12.9
Tax Allowance	6.5	7.6	9.3	10.2	10.7	11.1
Capital Carryover	0	0	(0.7)	(0.7)	(0.8)	(0.8)
Allowable Revenue	126.7	131.5	137.6	140.2	140.6	140.0

* working capital is added to Return on Capital.